



**City Water Circles**  
transnational online handbook on circular  
urban water management and use



# Content

## Thematic Catalogue 1

Smart assessment tools for potentials' mapping of urban water use 3

## Thematic Catalogue 2

Innovative engineering and nature-based solutions for circular water usage 61

## Thematic Catalogue 3

Smart governance tools fostering circular urban water usage 203

## Thematic Catalogue 4

Novel Digital Tools Promoting Water Efficiency Among Citizens/Consumers 248



Thematic Catalogue 1

# Smart assessment tools for potentials' mapping of urban water use



# Content

<b>1. INTRODUCTION</b>	<b>5</b>
<b>2. ASSESSMENT CRITERIA, PERFORMANCE INDICATORS AND METHODOLOGIES</b>	<b>6</b>
2.1. ASSESSMENT CRITERIA	6
2.2. PERFORMANCE INDICATORS (PIs)	7
2.3. BASIC METHODOLOGIES USED FOR THE ASSESSMENT OF WATER REUSE	8
2.3.1. Life Cycle Analysis (LCA)	8
2.3.2. Material Flow Analysis (MFA)	8
2.3.3. Environmental Risk Assessment (ERA)	9
2.3.4. Ecological Footprint Analysis	9
2.3.5. Health Risk Assessment	10
2.3.6. Multicriteria analysis (MCA)	10
<b>3. DECISION AND ASSESSMENT PROCESS OF URBAN WATER MANAGEMENT INVESTMENTS</b>	<b>11</b>
3.1. DIDACTIC EXAMPLE 1: Use of rainwater and purified wastewater for producing recycled construction material	12
3.2. ALTERNATIVE 0: Maintain the status quo without the use of recycled water in the production process	14
3.3. ALTERNATIVE 1: Use of recycled water for the production of construction products	15
3.3.1. Equipment and installation	20
3.3.2. Assessment of costs	23
3.3.3. Assessments of benefits	24
3.3.4. Cost-benefit assessment	26
3.4. MULTICRITERIA ANALYSIS OF ALTERNATIVES 0 AND 1	27
3.4.1. Setting the MCA criteria for investment alternatives 0 and 1	28
3.4.2. Economic comparison of alternatives 0 and 1	29
3.4.3. Environmental comparison of alternatives 0 and 1	29
3.4.4. Description of the benefits that cannot be valued with money	30
3.5. COMPARISON AND WEIGHTS FOR SELECTION OF THE OPTIMAL ALTERNATIVE	30
<b>4. GOOD PRACTICE EXAMPLES OF DEVELOPED AND TESTED ASSESMENT TOOLS IN THE FRAMEWORK OF EU INITIATIVES</b>	<b>33</b>
4.1. iWater TOOL - INTEGRATED STORM WATER MANAGEMENT TOOLBOX	33
4.2. AQUAENVEC TOOL - ENVIRONMENTAL AND ECONOMIC ASSESSMENT	38
<b>LESSONS LEARNT AND CONCLUSIONS FROM THE “CITY WATER CIRCLE” PROJECT PILOT INVESTMENTS - ANNEX</b>	<b>42</b>



# 1. Introduction

Well-functioning Central European cities should develop sustainably, meaning that their consumption of natural resources, needs to fit within the capacities of the local, regional and global ecosystems. Following this goal, it is suggested that city decision-makers take into account critical influencing factors related to the inward outward flow(s) of natural resources (e.g. food, water and energy) and manage them efficiently.

In accordance with mentioned, project “City water Circles” strives to introduce and promote water efficiency measures and the reuse of rainwater and greywater for public and domestic purpose in urban areas of Central Europe.

The project’s efforts are focused towards:

- strengthening capacities to create multi-stakeholder circular water use frameworks in the cities,
- fostering the adaptation of innovative measures through testing novel tools,
- ensuring wider policy uptake of circular water use measures on local, regional, national level.

In the “Thematic Catalogue 1: Smart assessment tools for potentials’ mapping of urban water use” we present the assessment tools, which can support decision- makers in their planning of future investments in the urban circular water measures.

The overall aim of an assessment tools for urban water reuse is to establish mechanisms and measures that can be applied to the evaluation process and provide a coherent approach for an integrated assessment. This involves the identification of all essential technical, environmental, economic and social assessment conditions which characterise the water reuse processes.

Many sets of multidisciplinary assessments and analysis methodologies exist, but their use in the decision-making process is quite demanding. It requires clear vision and goals of future policies, a lot of knowledge capacities and experience related to implementation of public investments, good data background, team effort and a lot of time for preparation.

In the Catalogue 1, we are not able to demonstrate the use of available assessment methodologies and tools in detail, because the use of methodologies and tools is quite complex and each would require a separate guidance catalogue, therefore the scope catalogue is focused on:

**Chapter 2:** Identifying possible assessment criteria and performance indicators and basic descriptions of methodologies and their purpose.

**Chapter 3:** presentation of decision and assessment process of urban water management investments using the approach of multicriteria analysis in a DIDACTIC EXAMPLE 1: “Use of rainwater and purified wastewater for producing recycled construction material”.

**Chapter 4:** presentation of two good practice examples of developed and tested assessment tools in the framework of EU initiatives.

**Annex:** Lessons learnt and conclusions from the “City water Circle” project pilot investments.



## 2. Assessment criteria, performance indicators and methodologies

The methodology process of assessing investments in circular water measures should include a comprehensive approach, taking into consideration the following measures:

- evaluation performance of reuse technologies using predetermined set of assessment criteria, and performance indicators,
- selection of relevant sustainability criteria that interrelate to technology performance including impacts, benefits and risks,
- providing objective ranking and benchmarking oriented towards best practice,
- generation of high-quality performance data that can be used as a mechanism with which performance can be measured, verified or compared.

Some questions which should be addressed in this context:

- What problems will the city be faced with in the future, if there is no change in the way of dealing with water?
- Does the planned water reuse project reduce or increase the environmental footprint?
- Which costs and which benefits are relevant for the property in a narrow view and for the municipality in an overarching view?
- What is the performance of alternative water reuse solutions compared to the current (conventional) ones?
- Which positive or negative social/economic impacts does water reuse generate?
- How to make decisions regarding the selection, design, implementation, and operation of a water reuse scheme?
- How to assess and compare performance of different water reuse schemes?
- What are the parameters for a uniform evaluation process?
- What knowledge is necessary to improve the decision-making process?

### 2.1. Assessment criteria

In the process of the identification of different assessment criteria and selection of indicators, the investor should perform a comparative assessment, comparing existing management situation with the proposed new solution. The goal of new solution/investment is to improve existing water management.

Some examples of possible technical, environmental, economic and social criteria, which can be used for this purpose.

#### 1. Technical assessment:

- Recycled water quality (quality standards)
- Operation & maintenance (expenditure)
- Technology performance
- Applicability
- Technological risks, etc.



Technology is the central feature of a treatment and technical assessment is the measurement of its performance and determines whether the treatment process achieves the required standards.

### **2.Environmental assessment:**

- Conservation of water resources
- Pollution reduction of receiving water
- Environmental benefits
- Environmental impacts
- Carbon footprint
- Ecological risks, etc.

### **3.Economic assessment:**

- Capital expenditure
- Operational expenditure
- Payback period (PBP)
- Economic efficiency
- Financial viability
- Economic drivers
- Cost benefits, etc.

### **4.Social impacts (benefits & risks): e.g.**

- Public perception and acceptance
- Public participation and engagement with stakeholders
- Employment/income generation
- Social inclusion and equity
- Financial opportunities
- Health risks (public safety and health)
- Governmental support, ect.

## **2.2. Performance indicators (PIs)**

Performance indicators are one of many tools that help quantify results and outcomes within the assessment process. PIs are defined as a set of quantitative indicators such as parameters, rates, limits, factors, etc. and may cover the following areas:

- Wastewater influent quality that may affect the process as a whole
- Pre-treatment process
- Secondary biological treatment
- Advanced/tertiary treatment (e.g. MF, MBR)
- Disinfection process
- Effluent water quality
- Recycled water quality
- CO<sub>2</sub> emissions, etc.



## 2.3. Basic methodologies used for the assessment of water reuse

Below we introduce basic methodologies, which can be used for the assessment of water reuse investments. As already mentioned in the INTRODUCTION chapter, the practical use of methodologies is quite complexed, therefore in this subchapter, we only present their main principles and purpose.

### 2.3.1. Life Cycle Analysis (LCA)<sup>1</sup>

Definition by (G. ItskosN., Nikolopoulos D., S.KourkoumpasA., KoutsianosI.,Violidakis P., Drosatos P., Grammelis, 2016, Pages 363-452): “LCA can be defined as a method that studies the environmental aspects and potential impacts of a product or system from raw material extraction through production, use, and disposal. The general categories of environmental impacts to be considered include resource use, human health, and ecological consequences. To allow for a consistent comparison between the different scenarios, it is necessary to define a common reference in order to express the results for the same output: this common reference is called the functional unit. The initial typical methodology was proposed by SETAC<sup>2</sup>. In the period 1997-2000, ISO standards introduced the stages of LCA methodology. Now, the ISO standards that are in force are given in the directive ISO 14044:2006.”

Stages of Life Cycle Analysis:

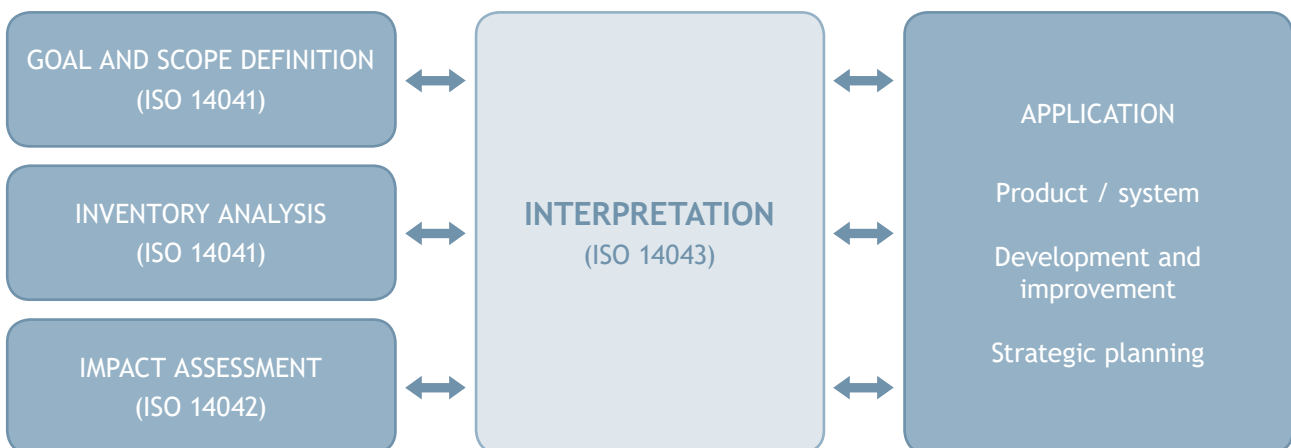

### 2.3.2. Material Flow Analysis (MFA)<sup>3</sup>

Material Flow Analysis (MFA) refers to the monitoring and analysis of physical flows of materials into, through and out of a given system (usually the economy). It is generally based on methodically organised accounts in physical units. It uses the principle of mass balancing to analyse the relationships between material flows (including energy), human activities (including economic and trade developments) and environmental changes. Material flows can be analysed at various scales

1 Environment and Development: Basic Principles, Human Activities, and Environmental Implications, G.ItskosN.NikolopoulosD.-S.KourkoumpasA.KoutsianosI.ViolidakisP.DrosatosP.Grammelis.  
<https://www.sciencedirect.com/topics/earth-and-planetary-sciences/life-cycle-analysis>, 18.2.2021

2 Society of Environmental Toxicology and Chemistry (SETAC) (<https://www.setac.org/>)

3 MEASURING MATERIAL FLOWS AND RESOURCE PRODUCTIVITY. Volume I. The OECD Guide, 2008  
<https://www.oecd.org/environment/indicators-modelling-outlooks/MFA-Guide.pdf> (18.2.2021)





and with different instruments depending on the issue of concern and on the objects of interest of the study. The term MFA therefore designates a family of tools encompassing a variety of analytical approaches and measurement tools, including accounts and indicators.

The principles of MF studies and of statistical approaches towards material flow accounts and material balances date back to the 1970s. Since the mid 1990s MF studies have been receiving increasing interest: first as a field of research promoted by academics (research institutes, universities), environmental NGOs, and increasingly also statistical offices; second as policy and information tools to support integrated decision making in the fields of natural resource, pollution, waste and materials management (at business and government level) and to contribute to the debates about sustainability issues. Countries are also increasingly interested in using material flow studies to better support policies and decisions concerning economic growth, international trade and globalisation, technology development and innovation.

### 2.3.3. Environmental Risk Assessment (ERA)<sup>4</sup>

ERA can be defined as the process of assigning magnitudes and probabilities to the adverse effects of human activities. The process involves identification of hazards (e.g., the release of toxic chemicals to the environment) by quantification of the relationship between an activity associated with an emission to the environment and its impacts. The entire ecological hierarchy is considered in this context, implying that the impacts on the cellular level, organism level, population level, ecosystem level and the entire ecosphere should be considered.

The application of environmental risk assessment is rooted in the recognition that:

- The cost of elimination of all environmental effects is impossibly high,
- The decision in practical environmental management must always be made on basis of incomplete information.

ERA is a process complementary to environmental impact assessment (EIA) , with the latter used to assess the impacts of a human activity. EIA is predictive, comparative and concerned with all possible effects on the environment, including secondary and tertiary (indirect) effects, while ERA attempts to assess the probability of a given (defined) adverse effect resulting from a considered human activity.

### 2.3.4. Ecological Footprint Analysis<sup>5</sup>

The ecological footprint is a method promoted by the Global Footprint Network to measure human demand on natural capital, i.e. the quantity of nature it takes to support people or an economy. It tracks this demand through an ecological accounting system. The accounts contrast the biologically productive area people use for their consumption to the biologically productive area available within a region or the world (biocapacity, the productive area that can regenerate what people demand from nature). In short, it is a measure of human impact on the environment.

4 Developments in Water Science. Part of volume: Lake and Reservoir Management. Edited by S.E. Jørgensen, H. Löffler, W. Rast, M. Straškraba. <https://www.sciencedirect.com/topics/earth-and-planetary-sciences/environmental-risk-assessment>

5 [https://en.wikipedia.org/wiki/Ecological\\_footprint](https://en.wikipedia.org/wiki/Ecological_footprint)



Ecological footprint analysis is widely used around the world in support of sustainability assessments. It enables people to measure and manage the use of resources throughout the economy and explore the sustainability of individual lifestyles, goods and services, organizations, industry sectors, neighbourhoods, cities, regions and nations.

### 2.3.5. Health Risk Assessment<sup>6</sup>

Human health risk assessment (HRA) is a process intended to estimate the risk to a population from exposure to a substance of concern. The process considers the type and composition of the substance, its potential to harm, the way in which people may be exposed (such as through direct exposure, inhalation of air or food and water consumption), how long people are exposed and how much they might be exposed to. The quality of a health risk assessment is dependent on the accuracy of the information available on all these matters.

The process needs to consider all substances that people are exposed to and how they interact. A good quality HRA will also clearly identify any uncertainties, assumptions and limitations considered during the assessment process. High uncertainty is associated with more precautionary risk management.

### 2.3.6. Multicriteria analysis (MCA)<sup>7</sup>

MCA includes the structured approach used to determine overall preferences among alternative options, where the options accomplish several objectives. In MCA, desirable objectives are specified and corresponding attributes or indicators are identified. The actual measurement of indicators need not be in monetary terms, but are often based on the quantitative analysis (through scoring, ranking and weighting) of a wide range of qualitative impact categories and criteria. Different environmental and social indicators may be developed side by side with economic costs and benefits. Explicit recognition is given to the fact that a variety of both monetary and nonmonetary objectives may influence policy decisions. MCA provides techniques for comparing and ranking different outcomes, even though a variety of indicators are used. MCA allows decision makers to include a full range of social, environmental, technical, economic, and financial criteria.

<sup>6</sup> [https://ww2.health.wa.gov.au/Articles/F\\_1/Health-risk-assessment](https://ww2.health.wa.gov.au/Articles/F_1/Health-risk-assessment)

<sup>7</sup> Communities and local governments: Multi-criteria analysis: a manual. Department for Communities and Local Government: London, 2009, pages 6-7, 19-20



### 3. Decision and assessment process of urban water management investments

The methodology process of assessing investments in circular water measures should include a comprehensive approach, taking into consideration the following measures:

In the urban water management, a lot of different measures and solutions exist, which are difficult to compare at a first glance. During preparation phase of investment projects, investor together with experts and stakeholders (users of future investment) should answer some key questions:

- What is the problem, what should be improved?
- What are the objectives to be achieved by the measure?
- According to which criteria should different proposed solutions be evaluated?
- Which non-monetary criteria are relevant for the selected measure?
- Which measure/solution is feasible for our project?
- Which measure/solution is environmentally compatible and economically viable?

Day-to-day practice identified following challenges related to assessment of investments:

- many decisions for or against a specific investment concept usually do not go through a transparent evaluation process,
- operating costs and non-monetary aspects are usually underestimated compared to the investment costs,
- the share of the water costs within the overall operating costs has been continuously increasing,
- to reach a viable economical decision, it is necessary to consider and assess different possible solutions and alternatives with respect to their costs and benefits.

In general, new community investments, include following steps:

- defining and setting goals of investment in advance,
- considering monetary and non-monetary goals and benefits,
- upon investor's decision the scale of importance of monetary and non-monetary criteria should be identified,
- preparation of assessment of possible investment solutions as soon as possible,
- comparing different alternatives with similar benefits.

To demonstrate how to comprehensively tackle mentioned assessment challenges and how to plan and implement water management investments in the urban areas, in accordance with circular water management goals we present a DIDACTIC example in following subchapter. To enable the assessment of investment alternatives also from environmental and social perspective, the monetary valuations, which are usually based on cost-benefit analysis (CBA), are complemented with multi-criteria analysis (MCA) with identification of selection criteria and weighting system including economic, environmental and social perspective.



### 3.1. DIDACTIC EXAMPLE 1: Use of rainwater and purified wastewater for producing recycled construction material

#### INTRODUCTORY NOTE

Presented didactic example “Use of rainwater and purified wastewater for producing recycled construction material” is a pilot investment, which will be realized in functional urban area (FUA) of Maribor, Slovenia, in the framework of City water Circle project.

The territory of the FUA Maribor covers 147,5 km<sup>2</sup> with population of 110.871 inhabitants, measured in 2018. Main river is Drava with flow rate approximately 670 m<sup>3</sup>/s and good water quality. The average annual precipitation is 926 mm.

The core of FUA Maribor is Maribor city centre. Water circle in FUA Maribor is covered by 3 companies. MBVOD (Maribor water supply) is responsible for drinking water supply, NIGRAD (stakeholder) is responsible for sewerage system and AQUASYSTEM for wastewater treatment.

#### CHALLENGE AND OBJECTIVES

In Europe’s urban and suburban areas, where most construction activities take place, large amounts of different types of waste are generated by utilities, the construction sector and other industries. This waste can be a valuable source of local secondary raw materials for construction work as a substitute for construction materials, while also being a business opportunity for construction companies (circular economy). Due to the lack of appropriate knowledge, technologies, good practices and incentives, the actors of supply and demand are modestly involved in such processes.

In 2016, 5.498 million tons of waste were collected in Slovenia, of which most was construction (2.165 million tons or 39%), followed by municipal (0.982 million tons or 18%) and industrial waste from thermal processes (0.905 million tons or 17%). Given that construction is the largest producer of waste in the execution of construction works (especially earthworks) and it is possible to use processed waste in large quantities in construction, entry into the cycle of the circular economy is inevitable and necessary.

Pilot investment will demonstrate the usability of recycled water for the purpose of production of secondary raw materials (SRM) based construction products. Produced materials will be used for road maintenance works and for revitalisation of degraded areas by public company Nigrad d.d, majority owned by Municipality of Maribor and concessionaire for public road maintenance. MBVOD will show that purified wastewater combined with harvested rainwater is suitable to be used in the production process.

The objectives of the pilot investment are the following:

- maximum rainwater retention,
- saving drinking water,
- promotion of biodiversity,
- water and soil protection,
- environmental education, etc.



## Thematic Catalogue 1

Didactic pilot investment example will evaluate two possible alternatives:

1. ALTERNATIVE 0: MAINTAIN THE STATUS QUO WITHOUT THE USE OF RECYCLED WATER IN THE PRODUCTION PROCESS
2. ALTERNATIVE 1: USE OF RECYCLED WATER FOR THE PRODUCTION OF CONSTRUCTION PRODUCTS USING PLASTIC RESERVOIRS WITH SEPARATE PUMPS AND AUTOMATION IN THE SHAFT AND ONE DRAIN

The purpose of the analysis of alternatives is to review an individual alternative from several aspects economic, environmental and social and compare them, which is the basis for deciding on the selection of optimal alternative.

**Background precipitation information needed for assessment of pilot investment alternatives.**

Table 1: Average monthly precipitation in Maribor FUA

Month	Quantity in mm	Month	Quantity in mm
January	32	July	81
February	108	August	93
March	61	September	49
April	67	October	53
May	221	November	46
June	103	December	8

Table 2: Average annual precipitation in Maribor FUA

Year	Quantity in mm	Year	Quantity in mm
1998	1.012	2009	1.078
1999	1.022	2010	986
2000	788	2011	720
2001	827	2012	929
2002	918	2013	924
2003	689	2014	1.238
2004	993	2015	846
2005	959	2016	1.006
2006	903	2017	961
2007	982	2018	926
2008	944		



### 3.2. ALTERNATIVE 0: Maintain the status quo without the use of recycled water in the production process

#### Technical presentation

Since Alternative 0, means maintaining the status quo, there is no investment in the rainwater collection system and no supply of wastewater for further re-use.

#### Cost-benefit assessment

The investor does not generate income/savings, so it remains in the amount of € 0.00 for a period of 30 years.

Table 3: Estimated revenues / savings Alternative 0, in €

Item	Year 1	Year 2	Year 3	Year 4	Year 5	Year 6..	..Year 30
Revenues	0		0	0	0	0	0
Total	0		0	0	0	0	0

As an operating cost of Alternative 0, we included the supply and drainage of water from the water supply system for a period of 30 years.

Table 4: Estimated costs of supply and discharge of drinking water Alternative 0, in €

Item	Year 1	Year 2	Year 3	Year 4	Year 5	Year 6..	..Year 30
Costs of supply and discharge of drinking water	0	1.025	1.035	1.046	1.056	1.067	1.354
Pollution tax	0	317	320	323	326	330	419
Total	0	1.342	1.355	1.369	1.382	1.396	1.773

As no investment in construction and equipment was made, there is no calculation of depreciation of fixed assets and the residual value of the project.

#### Investment efficiency of Alternative 0

The financial efficiency indicators of alternative 0 are shown in the following table.



Table 5: Financial efficiency indicators of Variant 0

Title	Abbreviation	Value
Incomes		0,00 €
Expenditures		1.342,46 €
Profit / loss	Income-expense	-1.342,46 €
Operating efficiency	Income/expense	0,00
Business profitability	Profit/income	0,00
Period of return on investment	(in years)	-
Financial internal rate of return	FRR/C	Cannot be calculated
Financial net present value	FNPV/C	-24.603,51 €
Relative net present value	relative FNPV/C	-

**CONCLUSION:** Although the yearly costs of supply and discharge of drinking water, appear quite low (1.342 -1.773 €), alternative 0, does not bring any benefits, such as technical solutions, which could be tested in local community, any environmental or social positive impacts, which could be assessed or could improve current conditions. It means that for the production of the raw construction materials, the drinking water will still be used also in the future. The net present value of the cost of drinking water for a period of 30 years means that these funds could be saved and represent about half the value of the investment into Alternative 1. Assessing the alternative only from the cost point of view would be misleading. The alternative 0 needs to be compared to the alternative that can also bring benefits (monetary and non-monetary).

### 3.3. ALTERNATIVE 1: Use of recycled water for the production of construction products

For the Alternative 1 rainwater and wastewater are used for the production of construction materials, using reservoirs with separate pumps and automation in the shaft and one drain.

#### Location presentation

The exact location of the pilot is at the degraded urban area in Dogoše, Maribor, where the pilot will be directly connected to the production plant for producing secondary raw materials based construction products operating at the same location. The Wastewater Treatment Plant is also nearby, making this the perfect implementation area.

The City Council of the Municipality of Maribor has confirmed the spatial rearrangement of the location where the demonstration will be implemented (the degraded area in Dogoše) as a basis for further actions. The demonstration is dependent on the SRM based construction products production process, since it will run concurrently, it is foreseen that the demonstration will take place at the latest in the second part of the 2020 (after August).



**Location of the pilot:**

Google maps approx. coordinates: 46.521096, 15.699536

**Location of the WWTP:**

Google maps approx. coordinates: 46.510826, 15.712678

Figure 1: Location of the pilot project



Figure 2: Detailed pilot project plan

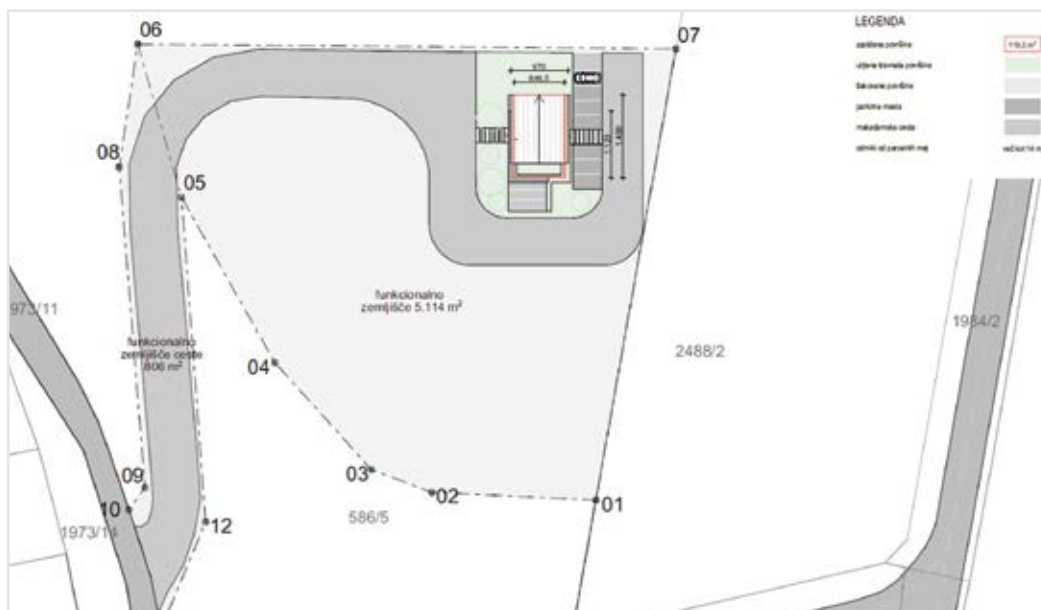

**Technical presentation**

The investor is building a facility with an available total area of 220 m<sup>2</sup> (roof and parking lot) from which rainwater flows into the municipal sewer. In the production of construction products, up to now they do not use recycled wastewater, but drinking water from the water supply network.





### Technical description

Two plastic reservoirs are installed underground, with installed concrete shaft in front of them in which there are installed filters, pumps and other necessary equipment.

### System operation:

The shaft has a built-in hydro booster station with two pumps, both pumps frequency controlled, control to maintain a constant pressure in the pressure system. Two probe modules are installed in the energy cabinet for each pump separately. As long as both pools are full, both pumps are running, each approx. 50%. If one of the pools is emptied, that pump does not run to the set level in the pool. An additional box with two switches for remote switching on and off of the pump is installed separately. The cabinet contains fuses for each pump separately, FID switch, power switch, two probe modules with six enclosed probes, additional fuse for light in the shaft, manual-automatic switch for each pump separately. Drain taps for water sampling are installed on the pressure side for each pump. An additional cabinet with pump control is located outside the shaft in any room.

Figure 3: Preliminary construction plan of reservoirs and equipment - Alternative 1

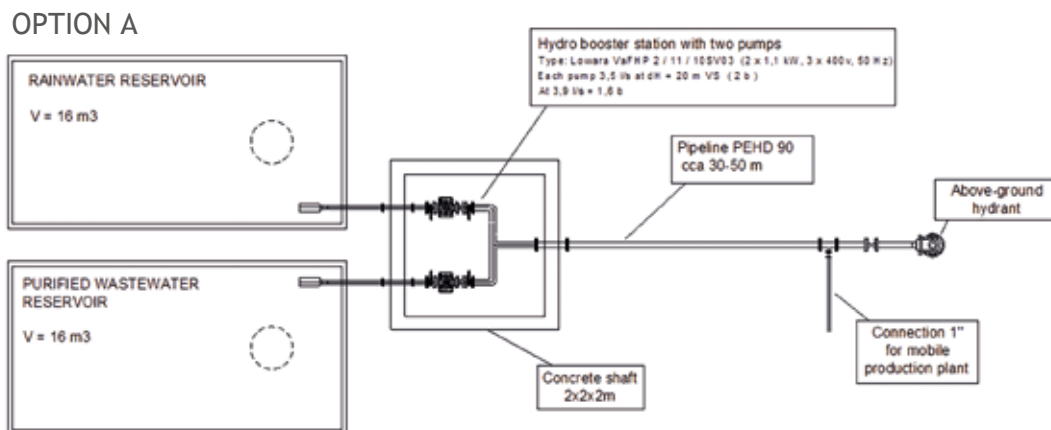

Table 6: Technical efficiency indicators

No.	Technical indicators	Unit of measure	Value
<b>A Reservoir</b>			
1	Volume	liter	2 x 16000
<b>B Pump</b>			
2	System operation (pumps)	Manual / automatic control	Automatic
3	The need for electricity per day	kWh	4.4
4	Space required	m <sup>2</sup>	31.2
5	Water flow	l/sec.	3.5
<b>C The amount of water needed</b>			
6	Rainwater	m <sup>3</sup> /year	168
7	Wastewater from WWTP	m <sup>3</sup> /year	192
8	Available rainwater harvesting areas	m <sup>2</sup>	320



## Thematic Catalogue 1

### Water usage and analysis

The water will be used for production of construction products that are based on secondary raw materials. Mobile production plant will be at the same location.

As part of the project, several water sources are foreseen to be analysed for their properties, which will be done concurrently with demonstration start. Types of recycled water to be analysed:

- Purified wastewater from WWTP
- Harvested rainwater

The samples will be taken in the equipment shaft next to the reservoirs or at the service point before the water is used for production process, with monitoring and analysis performed by National Laboratory of Health, Environment and Food.

Construction products made with recycled water will also be tested.

As a result, conclusions will be made, whether or not recycled water is appropriate for use in production process.

Consumption for production process

- Average water consumption: 3 m<sup>3</sup>/day
- Maximum water consumption: 10 m<sup>3</sup>/day
- Maximum water flow: 1,5 - 3 l/s

### Water collection

#### Rainwater

Rainwater will be harvested from roof surface of the building and the nearby parking lot. We are also considering rainwater harvesting from courtyard. Breakdown of surfaces:

- Roof approx. 120 m<sup>2</sup>
- Parking lot approx. 100 m<sup>2</sup>
- Courtyard approx. 100 m<sup>2</sup>

Runoff coefficient (Metal roof) = 0.8

Annual precipitation in Maribor FUA (10-year average) = 962 mm

If we consider roof and parking lot surfaces for rainwater harvesting, we can estimate the amount of rainwater that can be harvested in a year, based on following calculations.

$$220 \text{ m}^2 \times 962 \frac{\text{l}}{\text{year}} \times 0,8 = 169,310 \frac{\text{l}}{\text{year}} = 169.31 \frac{\text{m}^3}{\text{year}}$$

We can estimate to harvest about 170 m<sup>3</sup> of rainwater annually or 14 m<sup>3</sup> a month.



## Thematic Catalogue 1

Figure 4: Demonstration of a facility and areas for rainwater harvesting

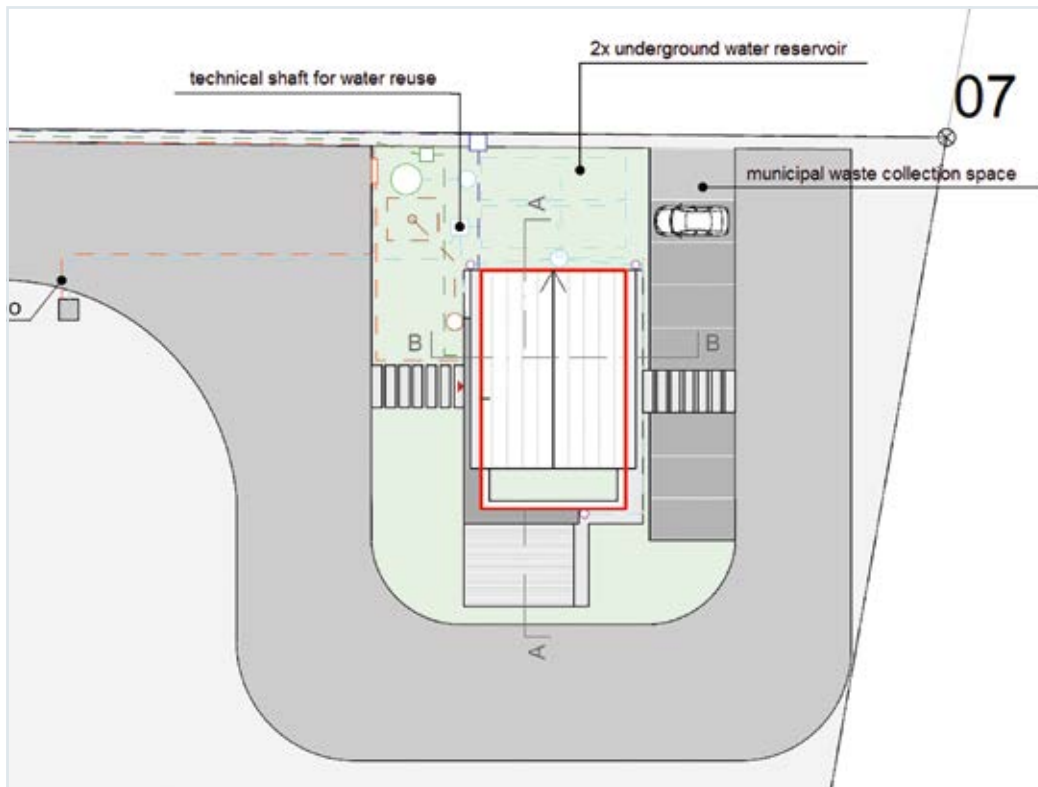

Based on harvested surface areas, predicted water consumption and annual and monthly precipitation in Maribor FUA, shown in tables and graphs below, reservoir with the volume 10-20 m<sup>3</sup> should suffice.

### Purified wastewater

Purified wastewater will be transported from Maribor Central Wastewater Treatment Plant with a suitable vehicle. Reservoir of the same size as for rainwater will be used (10-20 m<sup>2</sup>).

The quality of the wastewater on the outflow of mechanical and biological processes is tested daily with automatic sampler and the data is analysed and stored by the concessionaire of the wastewater treatment plant. In addition to internal daily monitoring, National Laboratory of Health, Environment and Food also performs monitoring twice a month.



Figure 5: Schematic view of water collection

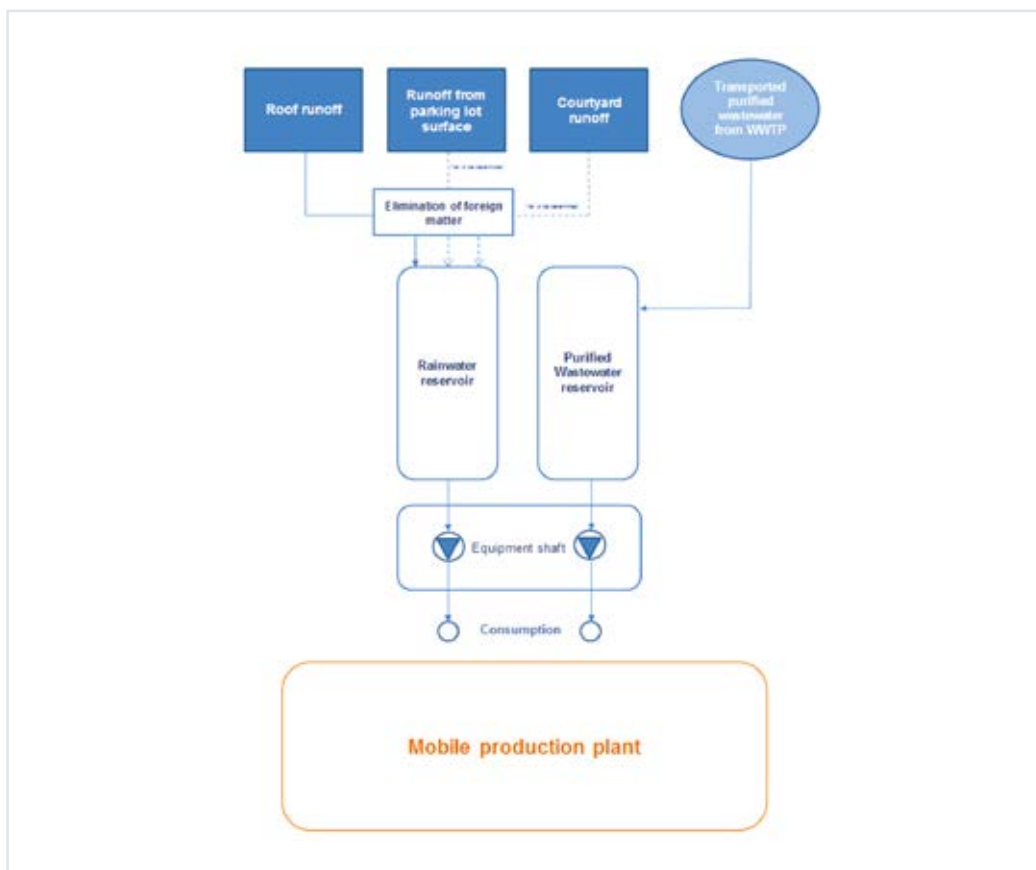

### 3.3.1. Equipment and installation

#### Preliminary construction plan

Two 16m<sup>3</sup> reservoirs (one for purified wastewater, one for rainwater) will be installed next to the production plant. Purified wastewater will be transported from WWTP, rainwater will be harvested on site.

#### Construction work for the installation of reservoirs and the transport of recycled wastewater

Excavation of the terrain, supply and installation of concrete, production of reinforced concrete floor slab, installation of a reservoir, mechanical backfilling of the terrain, installation of a buffer layer made of frost-resistant crushed stone, finishing works. Transport of 384 m<sup>3</sup> of recycled treated wastewater with a special vehicle with a storage reservoir from the location of the Maribor WWTP.

#### Reservoirs

RoTerra water reservoirs are used for rainwater collection purposes for home use. They are made of nature-friendly polyethylene and offer 100% waterproofing. The tank has an adjustable telescopic height  $\Phi$  600 x 500 mm, with which the height of the tank can be adjusted. A level walking cover made of polyethylene is installed on the lift, which is suitable for loads up to 200 kg. A large number of connections for inflow and outflow from the tank can be arranged on the tank. The shape and dimensions of the RoTerra tank allow easy manipulation on the construction site.



## Thematic Catalogue 1

The tank is checked and tested in accordance with the SIST EN 12566 - 3 standard.

Technical data	Values
Volume	16000 L
Dimensions L x D x H (mm)	4840 x 2300 x 2350 - 2850
Installation method	Underground
Diameter of inspection openings	2 x $\Phi$ 600 mm
Telescopic lift	$\Phi$ 600 x 0 - 500 mm
Material	Polyethylene PE
UV material stability	Yes
Inflow pipe diameter	DN 110, DN 125, DN 160
Outflow pipe diameter	DN 110, DN 125, DN 160
Standard	SIST EN 12566 - 3
Cover	PE walkable lid up to 200 kg

Figure 6: Reservoir RoTerra



Figure 7: Reservoir RoTerra dimensions

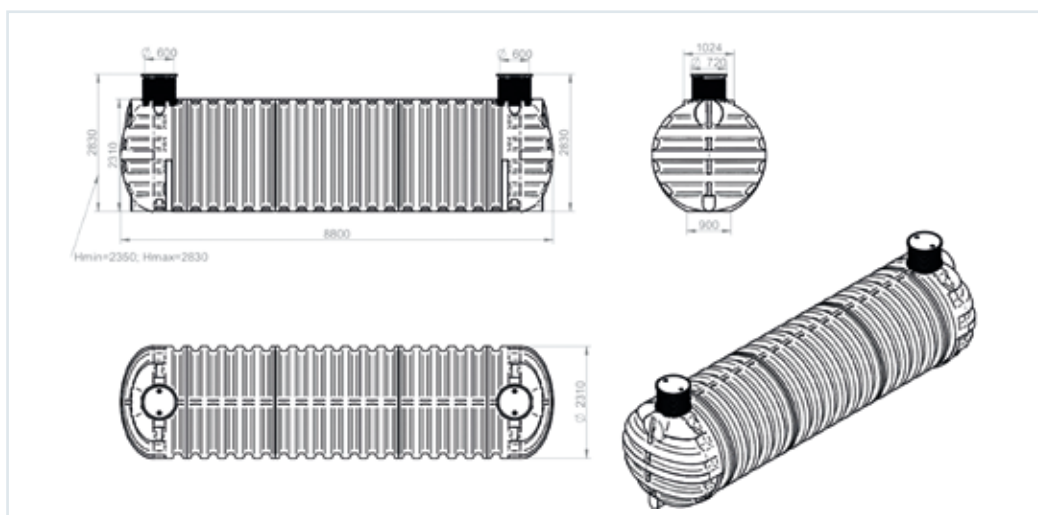



### Hydro booster station

Hydro booster station Lowara with two pumps.

Type: Lowara VaFHP 2 / 11 / 10V03 (2x1.1 kW, 3x400v, 50 Hz)

Each pump 3.5 l/sec at dH = 20 m VS ( 2 b )

At 3.9 l/sec = 1.6

Hydro booster station with two pumps, both pumps frequency controlled, control to maintain a constant pressure in the pressure system.

Pump set - Lowara (stainless steel) with clutch and flange connections.

Vasco 209 frequency inverters mounted on the pump motor.

Stainless steel pressure side hose set with all necessary valves and non-return valves, after installation of each sampling pump drain valve on the suction side without assembly, only ball valve.

2x membrane pressure vessel 20l

Pressure gauge on the pressure side.

2 x pressure sensor 4-20 mA, 0-10.

#### Special features:

Two probe modules built into the cabinet for each pump separately.

As long as both tanks are full, both pumps are running, each approx. 50%.

If one of the tanks is emptied, the corresponding pump does not run until the water reaches the pre-set level.

Additional dose with two switches for remote switching on and off of each station separately.

Fuses for each pump separately, FID switch, power switch, two probe modules with six probes, additional fuse for light in the shaft.

Manual automatic switch for each pump.

Figure 8: Hydro booster station with two pumps.

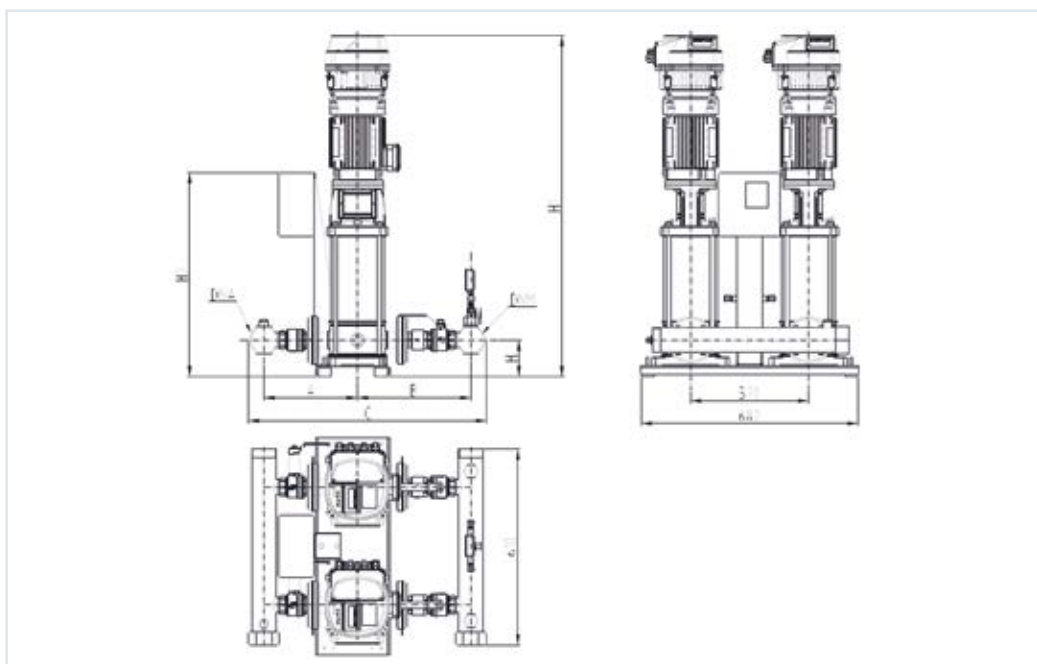



### 3.3.2. Assessment of costs

#### Investment costs

The investment value of the installation of 2 plastic reservoirs with separate pumps and automation in the shaft and one drain is € 39,255.47 including VAT. The breakdown of the investment value is shown in the following table.

Table 7: Estimated investment value

No.	Technical indicators	Unit of measure	Value	Total in €
<b>1</b>	<b>Construction work</b>			
1.1	fundamental works	234,40	51,57	285,97
1.2	earth and concrete works	7.863,84	1.730,04	9.593,88
1.3	transportation of recycled water from WWTP	3.609,60	794,11	4.403,71
1.4	unforeseen works (10%)	1.170,78	257,57	1.428,35
<b>2</b>	<b>2 plastic water reservoirs 16 m3</b>	<b>4.720,00</b>	<b>1.038,40</b>	<b>5.758,40</b>
<b>3</b>	<b>HP station with 2 pumps with control and automatic installation</b>	<b>3.176,00</b>	<b>698,72</b>	<b>3.874,72</b>
<b>4</b>	<b>Fine filter</b>	<b>264,00</b>	<b>58,08</b>	<b>322,08</b>
<b>5</b>	<b>Sanitary water filter</b>	<b>288,00</b>	<b>63,36</b>	<b>351,36</b>
<b>6</b>	<b>Supply and manufacture of concrete shaft 2x2x2m</b>	<b>3.850,00</b>	<b>847,00</b>	<b>4.697,00</b>
<b>7</b>	<b>Flow meters<sup>8</sup></b>	<b>2.000,00</b>	<b>440,00</b>	<b>2.440,00</b>
<b>8</b>	<b>Plumbing - material and installation works<sup>9</sup></b>	<b>3.000,00</b>	<b>660,00</b>	<b>3.660,00</b>
<b>9</b>	<b>Electrical work<sup>10</sup></b>	<b>2.000,00</b>	<b>440,00</b>	<b>2.440,00</b>
	<b>Total</b>	<b>32.176,62</b>	<b>7.078,85</b>	<b>39.255,47</b>

8 Cost estimate - we have a current public procurement for flow meters, the installation will be carried out by the workers of Mariborski vodovod

9 Cost estimate - we have a current public procurement for plumbing material, the installation will be carried out by the workers of Mariborski vodovod

10 Cost estimate - electrical work will be carried out by the workers of Mariborski vodovod



### Operating costs

The estimated operating costs include ongoing maintenance costs, part of the employee's salary and electricity. In the following table are shown for a period of 30 years. We anticipated that costs would increase by 1% per year.

Table 8: Estimated operating costs of Alternative 1

Item	Year 1	Year 2	Year 3	Year 4	Year 5	Year 6	Year 7	Year 8	...	Year 30
Ongoing maintenance costs	0	400	404	408	412	416	420	425	...	529
Labour costs	0	548	553	559	564	570	576	581	...	724
Electricity costs	0	190	192	194	196	198	200	202	...	251
<b>Total</b>	<b>0</b>	<b>1.138</b>	<b>1.149</b>	<b>1.161</b>	<b>1.172</b>	<b>1.184</b>	<b>1.196</b>	<b>1.208</b>	<b>...</b>	<b>1.503</b>

### Depreciation costs

Depreciation costs for a period of 30 years and the residual value of the investment are calculated in the table below.

Table 9: Depreciation costs in €.

Item	Value	Dep. rate	Year 1	Year 2	Year 3	Year 4	Year 5...	...Year 30	Residual value
Investment	39.255	3,33 %	0	1.307	1.307	1.307	1.307	1.307	1.346
<b>Total</b>	<b>39.255</b>		<b>0</b>	<b>1.307</b>	<b>1.307</b>	<b>1.307</b>	<b>1.307</b>	<b>1.307</b>	<b>1.346</b>

### 3.3.3. Assessments of benefits

#### Less drinking water consumption

According to the rainwater concept, in optimal conditions we could harvest approximately. 14 m<sup>3</sup> of rainwater per month. We assume that the reservoir for purified wastewater will be filled once a month (16 m<sup>3</sup>/month).

Table 10: Savings in drinking water consumption

Item	m <sup>3</sup> /day	m <sup>3</sup> /month	m <sup>3</sup> /year
Estimated average water consumption	3	66	792
Estimated average of harvested rainwater		14	168
Estimated average available purified wastewater		16	192
Estimated savings in drinking water consumption		30	360



**Financial benefits**

Below are the non-fixed costs calculations for water consumption, that depend only on water consumption. Fixed costs (like network charge) that are charged per month independent of consumption are not included in calculations. The prices are excluding VAT and are valid in August 2020 for Municipality of Maribor, where the pilot will be implemented.

Table 11: Price of water consumption and disposal in Municipality of Maribor

Item	€/m <sup>3</sup>
The price of drinking water	0,7437
The price of sewage disposal	0,3299
The price of wastewater purification	1,3056
The price of sludge removal	0,4679
<b>Total price of drinking water and wastewater disposal</b>	<b>2,8471</b>

Table 12: Estimated financial savings for drinking water consumption after implementation

Item	€/month	€/year
Costs for estimated average water consumption	187,91	2.254,90
Estimated costs for water consumption after implementation	102,50	1.229,95
Estimated savings in drinking water consumption after implementation	85,41	1.024,95

In optimal conditions we can estimate to save 85,41 € per month or 1.024,95 € annually in water consumption and disposal costs. Savings is also pollution fee 316,80 € per year ( $220 \text{ m}^2 \times 0,12 \text{ €/m}^2 = 26,40 \text{ € / month} \times 12 \text{ month}$ ).

The following table shows the estimated revenues or savings on the purchase of drinking water, without network charge (180 m<sup>3</sup>) for a period of 30 years. We anticipated that revenues would increase by 1% per year.

Table 13: Estimated revenues / savings

Item	Year 1	Year 2	Year 3	Year 4	Year 5	Year 6	Year 7	Year 8	...	Year 30
Revenues	0	145	147	148	150	151	153	154	...	192
Savings	0	1.342	1.355	1.369	1.382	1.397	1.410	1.425	...	1.773
<b>Total</b>	<b>0</b>	<b>1.487</b>	<b>1.502</b>	<b>1.517</b>	<b>1.532</b>	<b>1.548</b>	<b>1.563</b>	<b>1.579</b>	<b>...</b>	<b>1.965</b>



### 3.3.4. Cost-benefit assessment

The cost-benefit assessment is prepared upon presented investment, operating costs and financial benefits in subchapters 3.3.1 and 3.3.2.

The following assumptions were taken into account to calculate the efficiency of the alternative:

- VAT was taken into account in the item of investment costs.
- All costs and benefits (previous tables) have been taken into account in the financial calculations and do not include taxes.
- A 4% discount rate was taken into account.
- The following formula is used to calculate NPV:

$$NPV = \sum_{t=1}^n \frac{R_t}{(1+i)^t}$$

$R_t$  = Net cash inflow-outflows during a single period  $t$

$i$  = Discount rate or return that could be earned in alternative investments

$t$  = Number of timer periods

- The observed period for which calculations are prepared is the economic period of 30 years.
- All values are given in €

Table 14: Cost-benefit assessment

Financial indicators		
Title	Abbreviation	Value
Incomes		1.532,37 €
Expenditures		1.172,15 €
Profit / loss	Income-expense	360,21 €
Operating efficiency	Income/expense	1,31
Business profitability	Profit/income	0,24
Period of return on investment	(in years)	30
Financial internal rate of return	FRR/C	-5,58%
Financial net present value	FNPV/C	-30.919,80
Relative net present value	relative FNPV/C	-0,7877

**CONCLUSION:** Cost benefit assessment shows that the investment has non-profit nature. The minimum surplus of water savings over operating costs is not sufficient to cover investment costs over a period of 30 years at such a low price of water. In the case of rising water prices, this calculation would show minor negative value or even the positive value of that investment. But as we already said in Alternative 0 we have to assess the alternative also from non-monetary benefits.



### 3.4. MULTICRITERIA ANALYSIS OF ALTERNATIVES 0 AND 1<sup>11</sup>

As already emphasized, public community investment decision making, requires more than just evaluation of investment alternatives based on monetary valuations. All aspects of potential impacts need to be taken into consideration- also those non-monetised impacts. For that purposed we can upgrade the decision making limited to CBA analysis, with the use of Multi-criteria analysis (MCA), which can help to find the best suited solution for decision makers.

There are many Multi-criteria analysis (MCA) techniques widely acknowledged as methods of multi-criteria analysis, they cover a wide range of quite distinct approaches. All MCA approaches make the options and their contribution to the different criteria explicit, and all require the exercise of judgement. They differ however in how they combine the data. Formal MCA techniques usually provide an explicit relative weighting system for the different criteria.

The main role of the techniques is to deal with the difficulties that human decision-makers have been shown to have in handling large amounts of complex information in a consistent way.

From the literature, we can notice, there are many MCA techniques and their number is still rising. There are several reasons why this is so:

- there are many different types of decision which fit the broad circumstances of MCA
- the time available to undertake the analysis may vary
- the amount or nature of data available to support the analysis may vary
- the analytical skills of those supporting the decision may vary, and
- the administrative culture and requirements of organisations vary.

A key feature of MCA is its emphasis on the judgement of the decision-making team, in establishing objectives and criteria, estimating relative importance weights and, to some extent, in judging the contribution of each option to each performance criterion.

It does not matter, if we have small or large number of options/alternatives, it is important to bear in mind that each option has to be evaluated on each of set-criteria.

<sup>11</sup> Communities and local governments: Multi-criteria analysis: a manual. Department for Communities and Local Government: London, 2009, pages 6-7, 19-20



### 3.4.1. Setting the MCA criteria for investment alternatives 0 and 1

According to the set objectives of the pilot investment, investors from our didactic example (Maribor water supply company and Nigrad), identified four groups of MCA criteria were identified for the selection of the optimal alternative.

The following criteria were considered for the selection of the optimal variant:

#### 1. Technical criteria:

##### A. Reservoir

- volume - optimal tank volume

##### B. Pump

- system operation (pumps) - manual / automatic control,
- electricity demand / day - comparison of electricity consumption in kWh,
- required space - comparison of spatial needs in m<sup>2</sup>,
- water flow - the quantity of water (in liters) that flow in time (seconds)

##### C. The amount of water needed

- rainwater - the average annual amount of rainwater that will accumulate on the building surfaces
- wastewater from the WWTP - average annual amount of wastewater brought from the WWTP Maribor
- available rainwater harvesting areas

#### 2. Economic criteria:

- amount of investment costs - we compare the amount of investment costs,
- annual revenues and savings of the system,
- the amount of annual operating costs - we compare the amount of annual operating costs of the investment,
- price of operating costs € / m<sup>3</sup>,
- net present value (NPV) of the investment - we compare which value is the most optimal,
- payback period - we compare in which variant the invested funds are returned the fastest

#### 3. Environmental criteria:

- rainwater retention
- use of wastewater
- saving drinking water
- lower electricity consumption
- water and soil protection
- environmental education

#### 4. Social benefits (non-monetised impacts)

- positive impacts for local community (non-potable water can be used for further processing and is recycled, therefore the consumption of clean drinking water is reduced).
- educational value
- the use of the degraded area for development purpose.



### 3.4.2. Economic comparison of alternatives 0 and 1

Table 15: Comparison of investment alternatives and operating costs, in €

Item	Unit of measure	Alternative 0	Alternative 1
Investment costs with VAT	€	0,00	39.255,47
Annual revenues and savings of the system (in 2024)	€	0,00	1.532,37
Annual operating costs (in 2024)	€	-1.382,46	1.172,15
Operating costs	€/m <sup>3</sup>	-1.382,46	3,26
Period of return on investment	years	-	30
Net present value of the investment FNVP	€	-24.603,51	-30.919,80
Internal rate of return of the investments FIRR	%	-	-5,58%

### 3.4.3. Environmental comparison of alternatives 0 and 1

An overview of the environmental efficiency of the pilot project variants is shown in the following table.

Table 16: Environmental efficiency indicators of Alternatives 0 and 1

No.	Description of indicators	Alternative 0	Alternative 1
1	Rainwater retention	No	Yes
2	Use of wastewater	No	Yes
3	Saving drinking water	No	Yes
4	Lower electricity consumption	Yes	Partly
6	Water and soil protection	No	Yes
7	Environmental education	No	Yes



### 3.4.4. Description of the benefits that cannot be valued with money

The benefits of using recycled water for the purpose of producing construction products that cannot be assessed in money are as follows:

Table 17: social benefits

No.	Description of indicators	Alternative 0	Alternative 1
1	Positive impacts for local community	No	Yes
2	Educational value: gaining new knowledge capacities by implementing pilot investment	No	Yes
3	Use of the degraded area for development purpose.	No	Yes

## 3.5. COMPARISON AND WEIGHTS FOR SELECTION OF THE OPTIMAL ALTERNATIVE

MCA techniques commonly apply numerical analysis to a performance matrix in two stages:<sup>12</sup>

**1. Scoring:** the expected consequences of each option are assigned a numerical score on a strength of preference scale for each option for each criterion. More preferred options score higher on the scale, and less preferred options score lower. In practice, scales extending from 0 to 100 are often used, where 0 represents a real or hypothetical least preferred option, and 100 is associated with a real or hypothetical most preferred option. All options considered in the MCA would then fall between 0 and 100.

**2. Weighting:** numerical weights are assigned to define, for each criterion, the relative valuations of a shift between the top and bottom of the chosen scale.

For the identified MCA analysis groups of criteria: economic, environmental and social, 5 rank weight scale was set by investors.

Evaluation for the selection of the most favourable alternative for use of recycled water for the manufacturing construction products system has the following weights:

- 1 - very bad
- 2 - weak
- 3 - satisfactory
- 4 - good
- 5 - very good

<sup>12</sup> Communities and local governments: Multi-criteria analysis: a manual. Department for Communities and Local Government: London, 2009, pages 6-7, 19-20



## Thematic Catalogue 1

The scoring weights were assessed by investors (MBVOD and Nigrad), in accordance with the set goals, related to investment:

- ability to use of rainwater and wastewater, meaning saving drinking water for production of construction material,
- maximum rainwater retention on-site,
- water and soil protection,
- environmental education, knowledge from pilot investment can be used in future circular water measure investments.

Table 18: Evaluation of alternatives using set of identified four criteria (technical, economic, environmental and social benefits)

No.	Items	Unit of measure	Alternative 0	Alternative 1
<b>I TECHNICAL CRITERIA</b>				
<b>A Reservoir</b>				
1	Volume	litre	1	5
<b>B Pump</b>				
2	System operation (pumps)	Manual/automatic control	1	5
3	Electricity demand	kWh	1	3
4	Required space	m <sup>2</sup>	1	5
5	Water flow	l/sec.	1	3
<b>C The amount of water needed</b>				
6	Rainwater	m <sup>3</sup> /year	1	5
7	Wastewater from WWTP	m <sup>3</sup> /year	1	5
8	Available rainwater harvesting areas	m <sup>2</sup>	1	5
<b>II ECONOMIC CRITERIA</b>				
9	Investment costs with VAT	€	1	4
10	Annual revenues and savings of the system (in 2024)	€	1	3
11	Annual operating costs (in 2024)	€	1	3
12	Operating costs	€/m <sup>3</sup>	1	5
13	Period of return on investment	years	1	3
14	Net present value of the investment FNVP	€	1	4
<b>III ENVIRONMENTAL CRITERIA</b>				
15	Rainwater retention	-	1	5
16	Use of wastewater	-	1	5
17	Saving drinking water	-	1	5
18	Lower electricity consumption	-	1	3
19	Water and soil protection	-	1	5
<b>IV SOCIAL CRITERIA</b>				
20	Positive impacts for local community	-	1	5
21	Environmental education	-	1	5
22	Use of degraded land	-	1	5
<b>RESULT</b>			<b>22</b>	<b>96</b>



## Thematic Catalogue 1

Conclusion: the evaluation table demonstrates that the optimal investment alternative, is alternative 1, due to the fact that it brings positive technical, environmental and social benefits, which are in line with the set goals of the investors. As we said before the assessment of economic criteria should be a less important part of the assessment (in this assessment 6 criteria of total 22). This is especially case for public buildings or public investments, which must demonstrate other environmental and social benefits than just economic ones.





## 4. GOOD PRACTICE EXAMPLES OF DEVELOPED AND TESTED ASSESMENT TOOLS IN THE FRAMEWORK OF EU INITIATIVES

Urban planning in the past years has greatly evolved and has many aspects and domains (technical, ecological, economic and social) that need to be considered, in order to guarantee sustainable and quality urban living, along with the fact, that urban water management has also developed and requires multidisciplinary approach.

Many good practices were developed and tested in the framework of different EU initiatives. In this chapter we present a few, that used a comprehensive approach in assessing urban water management.

### 4.1. iWater TOOL- INTEGRATED STORM WATER MANAGEMENT TOOLBOX

Integrated storm water management toolbox was developed and tested in the framework of Inter-reg Central Baltic Programme 2014-2020 project, called »iWater<sup>13</sup> « with the purpose to improve urban planning in the cities of Baltic Sea region. The iWater project has an EU Strategy for the Baltic Sea Region Flagship status for Horizontal Action Climate.

Project key activities:

- Improvement of existing urban planning
- Development of 7 stormwater strategies
- Adaptation of new stormwater approaches and tools
- Setting the evaluation criteria for peer review within the stormwater management
- Development of capacities and exchange of best stormwater management practices
- Dissemination activities.

#### ABOUT TOOLBOX

Toolbox includes commonly used approaches and practical tools for urban stormwater management.

For WHO?

- Landscape architects
- Architects
- Urban planners and designers
- Interested or working with the design/planning or management of urban water.

<sup>13</sup> <http://www.integratedstormwater.eu/about>



## Thematic Catalogue 1

### Characteristics

Toolbox covers three domains. These three domains cover the actions needed in different planning levels for development of multifunctional and resilient water system.

THREE POINTS APPROACH	
URBAN RESILIENCE	Includes spatial planning solutions or tools focusing on mitigating the effects of possible rain and technical basis for adaptation to future changing scenarios.
TECHNICAL OPTIMIZATION	Includes solutions and tools for mitigating stormwater, with the purpose to meet politically defined service level, taking into consideration local characteristics.
DAY-TO-DAY VALUES	Solutions to manage stormwater are aiming at delivering multiple ecosystem services and need to be incorporated into daily functioning of urban spaces in order to present a quality solution.



## Thematic Catalogue 1

### Tools presented

In order to help experts, stakeholders and decision makers to comprehensively manage the stormwater in urban areas, toolbox includes 16 different tools. Tools are categorized into following groups:

CATEGORY	*DESCRIPTION
1. STRATEGIC APPROACHES	<ul style="list-style-type: none"> <li>• Education and engagement (practices that provide an opportunity to educate and engage communities about water management)</li> <li>• Green infrastructure (network of natural and seminatural features, including forests, parks, green roofs, street trees, rivers and wetlands)</li> <li>• Low Impact development water sensitive urban design</li> <li>• Source control (small-scale techniques in order to reproduce/maintain predevelopment hydrologic conditions)</li> <li>• Water sensitive design</li> </ul>
2. PLANNING SUPPORTING TOOLS	<ul style="list-style-type: none"> <li>• Certification systems</li> <li>• Cloudburst management plan</li> <li>• Flood risk assessment and mapping</li> <li>• Green (Area) Factor GAF (known as Green Space Factor and Biotope Area Factor, a tool to enhance green infrastructure on private properties)</li> <li>• Green infrastructure audit (to map and analyse green infrastructure features and elements of specific area)</li> <li>• Living waterways</li> <li>• Stormwater programmes and guidelines (documents describing stormwater management principles of government/municipality)</li> <li>• Run-off coefficient calculation (ratio of the run-off depth to precipitation depth)</li> <li>• Watershed assessment (analysing possible impacts of land-use changes due to stormwater run-off)</li> </ul>
3. DESIGN/STRUCTURAL SOLUTIONS	<ul style="list-style-type: none"> <li>• Sustainable stormwater management solutions</li> <li>• Green streets</li> <li>• Sustainable Urban Drainage system best management practice</li> </ul>
4. ASSESSMENT TOOLS	<ul style="list-style-type: none"> <li>• iWater assessment criteria</li> <li>• Costs and Benefits of sustainable urban drainage solutions (so called "SuDS")</li> <li>• Analysis of Ecosystem services of Sustainable stormwater solutions</li> </ul>

\*Detailed description of each tool provided: <http://www.integratedstormwater.eu/iwatertoolbox>, Tools Collection Archive.



## Thematic Catalogue 1

### Important facts

Important facts acquired from the toolbox use:

*In order to have a quality planning and assessment combined approach of different tools is needed. The most relevant challenges concerning stormwater management is that characteristics of the regions should be taken into consideration.*

*The tools for urban water management are becoming broader and are evolving from so called pipe-based drainage systems to multifunctional systems, including SOCIAL and ECOLOGICAL aspects.*

### Pilot project cities and sites

The toolbox has been tested in following project pilot cities, facing diverse stormwater challenges.

CITY	STORMWATER CHALLENGE	OBJECTIVE
Gävle, Sweden (Kryddstigen Industrial area)	The planning site is located within the area of the city's responsibility for stormwater management, which means that the city is responsible for receiving clean stormwater into the existing stormwater pipes up to a flow equivalent to a 10 years rainfall. Often, however, the pipes are undersized. Stormwater which cannot be received in the drainage system, must be handled locally by delay and/or infiltration.	Gävle city would like to get suggestions on how the planning site can manage the stormwater, with solutions that work both from a flooding and purification point of view.
Helsinki, Finland (Stormwater filtration unit pilot in Taivallahti)	As the city structure becomes denser and the area of impermeable surfaces increases, the amount of stormwater increases. Stormwater is often contaminated by undesirable substances originating from air pollution, various surfaces, effluents, accidents, pipe ruptures and other events. The quality of stormwater needs to be improved before releasing to the water system to prevent the pollution.	Stormwater from heavily trafficked nearby street called Mechelininkatu will be directed into stormwater pipe and released into Taivallahti Bay. In pilot phase, part of the stormwater is directed into the stormwater filtration unit before releasing it to the sea. The unit purifies road pollution and debris (microplastics, suspended solids and other pollutants) from the water while it passes through the coarse and fine filtration units.
Svete in the city Jelgava, Latvia	Major flood events happen in the territory in every ten years. In the springtime, when snow is melting, a lot of water flows into the river from the territory and causes floods in the area of the city.  Storm water system is not properly created in many territories, the ditches are created without a runoff and are not managed, even a small ditch or culverts congestion affects a large urban area.	The creation of complex solutions in the developing territories as well as in existing residential areas is initiated by Jelgava municipality.



## Thematic Catalogue 1

CITY	STORMWATER CHALLENGE	OBJECTIVE
Riga, Latvia (TORŅAKALNS neighbourhood)	According to the Land use Plan for the city of Riga, the pilot site lies within the territory that has a status of the “Drainage Territory” (territory that should be drained up prior to building). In the pilot site water drainage is ensured through open ditches system. Direct runoff from land plots to open ditches is lied out, however, the runoff from empty land plots is weak and thus the drainage is insufficient - mainly due to poor conditions of open ditches that are silted or destroyed	Development plans of pilot site apply to revitalization of green zones and improving their functionality by adding sustainable storm water retention and drainage functions that are based on green infrastructure solutions.
Söderhamnsporten, Söderhamn, Sweden	In August 2013, a heavy rainfall caused a major flood in the area. This was causing problems for the important traffic functions in the area.	To solve flooding problems and to realize other plans connected with the development of the area.
Tartu, Estonia Site A: Jaamamõisa area Site B: Annelinn, Väike Anne channel area	Site A: GAF tool was adapted as a planning tool in Tartu. Site B: part of the largest residential areas built mainly in the 1970 years. The possibilities of using the ditches for the stormwater purification before reaching Emajõgi is under research. Further, analysis of the potential needs as well as benefits of using an Integrated stormwater management system in existing residential area is ongoing.	Site A: The main focus was on finding and testing ideas on how to use stormwater as a resource in urban planning. Site B: Finding out, if the stormwater of this catchment area could be managed not using Väike Anne Channel.
Kirstinpuisto City Plan (Kirstinpuiston asemakaava) Turku, Finland	Stormwaters are led to the sea through a stormwater pipeline which is already on the limit of its maximum capacity. The situation is worsened by the regional wastewater treatment plant which leads its effluent waters to the same pipeline.	The peak loading of the stormwater pipeline should be reduced. Therefore, the aim is to retain as much stormwater as possible within the new city plan areas, such as Kirstinpuisto.

### More detailed information about the project and toolbox, references:

About the project iWater: <http://www.integratedstormwater.eu/about>

About the toolbox: <http://www.integratedstormwater.eu/iwatertoolbox>

About pilot sites: <http://www.integratedstormwater.eu/pilot-sites>



## 4.2. AQUAENVEC TOOL - ENVIRONMENTAL AND ECONOMIC ASSESSMENT

“Aquaenvec tool” was developed and tested in the framework of LIFE project “Aquaenvec -Assessment and improvement of the urban water cycle eco-efficiency using LCA and LCC.

The focus of the project was to integrate environmental and economic assessment into a comprehensive study of the eco-efficiency of the urban water cycle.

Project wanted to provide decision making tools to optimise eco-efficiency, through environmental and economic analysis to ensure a sustainable management of urban water cycle.

The following analysis are provided:

- Life Cycle Analysis (LCA) and impact reduction potential of urban water cycle
- Life Cycle Costing (LCC) and evaluation of costs savings in the urban water cycle
- Environmental, economic and eco-efficiency indicators to support decision making and promote sustainable use of natural resources and reuse of end products
- User-friendly tool development to support policy makers and public and private managers.

### ABOUT TOOL

“Aquaenvec tool” is a user-friendly web tool developed to assess and improve the eco-efficiency of water activities in the urban areas.<sup>14</sup>

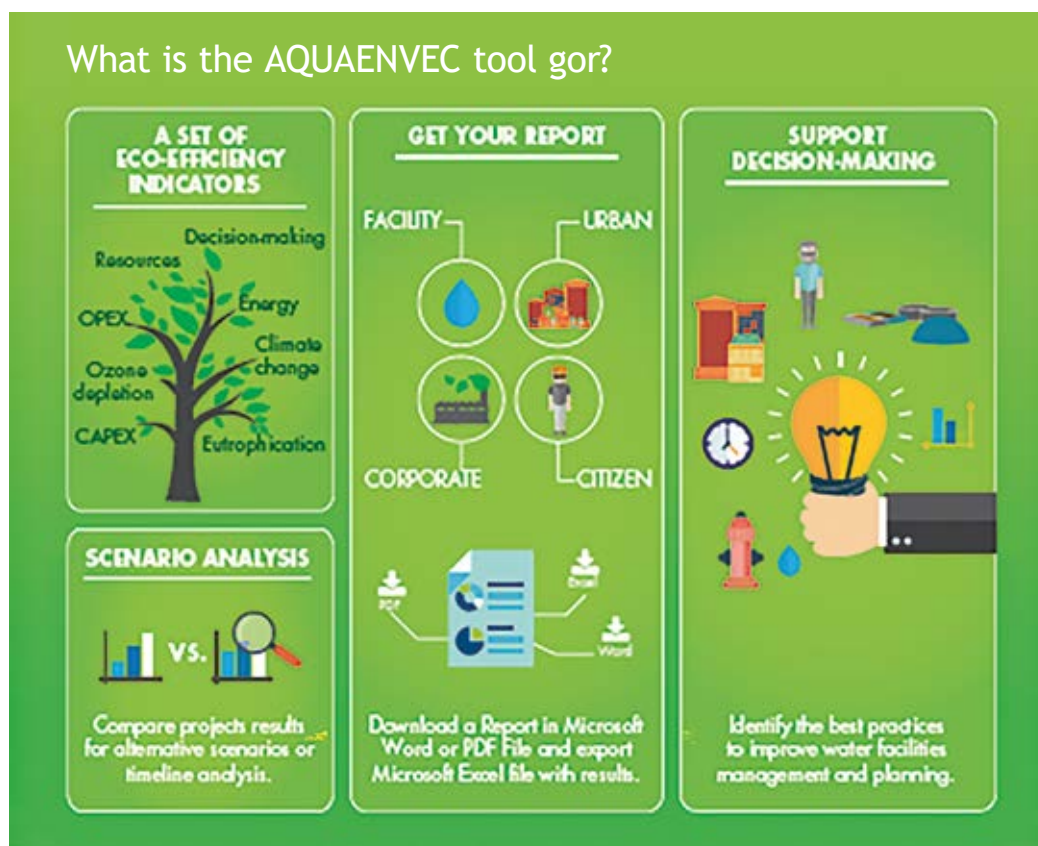

14 <http://www.life-aquaenvec.eu/the-aquaenvec-tool/>



## Thematic Catalogue 1

### For who?

- For public and private water managers.

### Characteristics

- An innovative eco-efficiency approach including
- Entire urban water cycle
- Environmental impact reduction (LCA)
- Cost minimisation (LCC)

### Usage of tool

- The tool is available on-line, no installation is needed
- The tool has been developed in English and Spanish
- It includes set of environmental, economic and eco-efficiency indicators
- Identifies best practices to improve results
- User is able to download a report in Word or PDF File or export results in excel file
- Different projects results can be compared (scenario analysis).

### Tool features and functioning

Registration	Username, password, contact details, organization, field of expertise and expectance of legal terms of use.
Creation of the new project for assessment	<p>There are different possibilities to create a new project. The user can choose between an urban water cycle project (including all the stages of the cycle) and a single water facility. In case of choosing single water facility, user must indicate also which stages of the water cycle will be considered: DWTP (drinking water treatment plant), supply network, sewer network and WWTP (wastewater treatment plant).</p> 



POSSIBILITY 1: USE OF THE TOOL IN THE CASE OF URBAN WATER CYCLE SYSTEM (all stages included)

Data about the city to study

1.STAGE	DRINKING WATER TREATMENT PLANT
STEP1: Inclusion of general data	<p>Chemical treatment: chemical dosing</p> <p>Membrane treatment: membrane treatment</p> <p>Extended disinfection: extended disinfection</p> <p>Sludge treatment: thickening, dewatering (filtration, centrifugation), drying (thermal drying, automatization, solar drying)</p> <p>Sludge to final disposal (sludge to landfill, sludge to energy recovery and sludge to recycling)</p>
STEP2: Validation	<p>After inclusion of general data in Validation step, a tool will provide a set of recommendations about the processes and treatments as a user guide</p>
STEP3:	<p>Inclusion of current data about operation and maintenance. In the Treatments section you will see the designed scheme and, for each element, you will be able to modify its specific characteristics. This step also enables to include more data about waste disposal, water quality, drinking water quality, renewable energy used.</p>
2. STAGE	SUPPLY NETWORK
STEP1: Inclusion of general data	<p>Characteristics about network and connections (lifespan of network, peak population, water connection, etc.).</p>
STEP2: Inclusion of information about supply network	<p>Construction section: the user adds description of pipes and other materials of the network.</p> <p>Summary information: a graph of pipe materials is presented, including information about the type of material, size, length.</p>
STEP3: Inclusion of data about operation and maintenance	<p>Four subsections are included: consumables (electricity and sodium hypochlorite disinfection), network replacement, appurtenances replacement and other maintenance issues (leakages, personnel costs, laboratory, cleaning, etc.).</p>





## Thematic Catalogue 1

3. STAGE		SEWER NETWORK
STEP1: Inclusion of general data	Data referring the network and the type of sewer network: served population, collected water, climate, etc. Again, some assumptions about the network elements are presented.	
STEP2: : Inclusion of data about operation and maintenance	<p>Energy consumption: electricity data.</p> <p>Network replacement: add annual replacement pipes as explained previously in the Construction section.</p> <p>Appurtenances replacement: add annual replacement appurtenances, as explained previously in the Construction section.</p> <p>Sewer cleaning and inspection: electricity consumption, petrol, diesel, cost of cleaning, waste management, etc.</p> <p>Other operation and maintenance issues: personnel cost, maintenance, laboratory and analysis.</p>	
4. STAGE		WASTEWATER TREATMENT PLANT
STEP1: Inclusion of general data	Name of the facility, flow related data, the number of served municipalities and the population equivalent	
STEP2: design section	<p>Design section is very similar to the one in the DWTP stage, but the treatments are different.</p> <p>Specifics about water treatment.</p> <p>Sludge treatment.</p>	
STEP3: Inclusion of data about operation and maintenance	Inclusion of data about the operation and maintenance. In the Treatments section you will see the designed scheme and introduce more information about the waste disposal, with the same parameters as in the DWTP stage. Regarding the water quality (inlet or outlet), it is possible to enter data related to the directive urban wastewater discharge (91/2717ECC), metals, PPCPs and priority substances. In the Other operation and maintenance issues section you can enter the diesel and natural gas consumption.	
5. STAGE		VIEWING A PROJECT'S RESULTS REPORT
RESULTS	<p>Once you have completed correctly all the active stages in a Project, you can click on the Results button to access and view a set of reports.</p> <p>Environmental results: present data about the global warming potential, the eutrophication potential, the ozone layer depletion potential and the cumulative energy demand.</p> <p>Economic results: data about the costs in the lifecycle, volumetric costs, annual costs in the operation and maintenance, annual costs per citizen and more information depending on the stage and section selected.</p> <p>Eco-efficiency result includes a cross view of the environmental and economic data.</p>	
POSSIBILITY 2: USE OF THE TOOL IN THE CASE OF SINGLE WATER FACILITY		
	Choosing single water facility, user must indicate which stages of the water cycle will be considered: DWTP (drinking water treatment plant), supply network, sewer network and WWTP (wastewater treatment plant).	



Thematic Catalogue 1

**ANNEX**

Lessons learnt and conclusions from the “City  
water Circle” project pilot investments

**Annex**



# Introduction

The purpose of Annex is to introduce the 5 pilot project investments within the CWC project and to present lessons learned.

The primary goal of the implemented pilot actions is to create a base knowledge for urban circular water management taking into consideration the specific local needs and requirements.



# SHORT PRESENTATION OF PILOT PROJECT INVESTMENTS

The 5 implemented pilot actions adopted different solutions and measures for rainwater management and waste(grey)water recycling which are summarised in Table.

**Table:** The 5 pilot actions implemented within the CWC project

	PILOT	RAINWATER HARVESTING	GREYWATER RECCLING & REUSE	TREATED WASTEWATER REUSE	URBAN FOOD PRODUCTION FROM RAINWATER	SMART METERING & WATER EFFICIENCY
1	Combined rainwater and greywater reuse in a Kindergarten in Zugló, Hungary	✓	✓			
2	Rainwater recovery rooftop garden and aeroponic greenhouse in Turin, Italy	✓			✓	
3	Use of rainwater and purified wastewater for producing recycled construction material in Maribor, Slovenia	✓		✓		
4	Rainwater utilisation via rooftop rainwater harvesting serving rain gardens in Bydgoszcz, Poland	✓				
5	Demonstrating water saving via smart metering and developing a supportive mobile application in Split, Croatia					✓



**PILOT INVESTMENT 1:  
Implementation of combined rainwater and greywater reuse in a Kindergarten in Zugló,  
Hungary**

The pilot demonstrates circular water use (CWU) via rainwater harvesting and greywater recycling in a Kindergarten in Zugló district in Budapest. Treatment of the collected rainwater and greywater streams takes place in a constructed soil filter and the stored water is reused to flush the toilets and for irrigation of green space.

**Pictures:** Yard in Hétszínvirág Kindergarten and water tank embedding in the garden<sup>1</sup>



**Pictures:** Indoor construction works and replaced toilet flush with greywater<sup>2</sup>



1 Photo: Zugló Municipality  
2 Photo: Zugló Municipality



### Outputs:

- Rainwater harvesting system from roof surface areas of the Kindergarten
- Greywater network system collecting greywater from 9 hand washbasins and one shower
- Two underground cisterns for the storage of rainwater and greywater
- A constructed soil filter (sand and gravel of different grain sizes) for the treatment of rainwater and greywater
- Eight toilet flush units connected to the water recycling system
- Booster pump for the distribution of treated water with corresponding piping network, shafts, filters, etc.

### Challenges:

- One of the biggest challenges was the economic impact of Covid-19 pandemic which resulted in the central government making radical financial restrictions in municipal budgets. Under the initial retrofit plans of the municipality, the kindergarten should have undergone a complex renovation work and the circular water management elements were to be harmonised with these renovations. Changes in design plans were also made. For example, green roofs were found unsuitable for the outdated structure of the existing roof which was also in a poor statical condition, and thus was deleted from the concept.
- Increasing prices in the construction industry in the post Covid-19 period, for which a concept redesign with a lower budget was necessary.
- It was a challenge to bring the finalised concept into conformity with the parallel interventions of the Zugló Asset company, which was responsible for the investment tasks but only joined at a later stage of the project.
- Unforeseeable problems during excavation works (e.g. presence of an old oil tank in the soil which had to be removed; an old huge tree had to be uprooted; a gas pipe was not indicated on map, etc.).

### Impacts:

- Preserve water resources and save drinking water
- Increase onsite rainwater retention
- Reduce stormwater flow and drainage on site and protect against flooding
- Relieve the load on public sewer network
- Reduced drinking water bills
- Raise awareness on circular water use and water saving. As a member of the “Hungarian Green Kindergartens Network”, the pilot site offers high potential for dissemination and spread of knowledge on circular water use.

### Monitoring results:

- Monitoring activities included chemical and microbiological parameters of the collected and re-used rainwater and greywater.
- The first water quality assessment was realised by the accredited laboratory of Budapest Water Works in early April 2022, after the first significant rain of the year.
- Water quality requirements should follow the EU Directive for Bathing Water<sup>3</sup> for indoor use of recycled water for toilet flushing.

<sup>3</sup> <https://eur-lex.europa.eu/legal-content/EN/TXT/?uri=CELEX:32006L0007>



**PILOT INVESTMENT 2:**

**Rainwater recovery rooftop garden and aeroponic greenhouse in Turin, Italy**

The pilot demonstrates rainwater management at the building level by adopting Nature Based Solutions (NBS). Rainwater from roof surfaces is harvested to feed a rooftop garden (intensive green roof) and a greenhouse-based aeroponic cultivation system for urban food production. Excess rainwater is drained into a rain garden built at the entrance of the building to promote infiltration on site and thus close the water cycle.

Picture: The green roof and the greenhouse<sup>4</sup>



Picture: The rain garden<sup>5</sup>



4 Photo: Alessandra Aires.

5 Photo: Alessandra Aires.



## Thematic Catalogue 1

### Outputs:

- Harvested rainwater which is stored, reused and infiltrated on site
- Intensive green roof
- Aeroponic system for food production from harvested rainwater
- Two storage tanks for harvested rainwater
- Rain garden

### Challenges:

- Unforeseen retrofit works in the building. Since the building was built in 1940 some technical, aesthetic, and infrastructural barriers had to be solved, which required modifications in the original design concept.
- A long procurement phase due to bureaucratic hurdles, in addition to the long time required to check and approve the financial soundness of the contracted company
- Lack of material in the post Covid-19 period, in addition to the significant increase in material costs.

### Impacts:

- Flood prevention and runoff reduction on site through rainwater retention
- Reuse rainwater to support green infrastructure and food production
- Improve the microclimate and decrease heat island effects
- Increase urban amenity and biodiversity
- Enhance services offered by ecosystems and NBSs
- Generate consciousness, engagement and awareness among citizens

### Monitoring results:

The local water utility (SMAT) has been subcontracted by the municipality of Turin to conduct the monitoring activities on site. Flow metres and data loggers are installed to measure the amount of harvested and reused rainwater for the green roof and aeroponic system as well as the amount of backup water (drinking water) used. Water quality analysis of the harvested rainwater upstream, and rainwater in the storage tank and downstream following UV disinfection will be conducted. The monitored parameters include E. coli, enterococci, total coliforms, turbidity, pH, TSS and colour.





**PILOT INVESTMENT 3:**

**Use of rainwater and purified wastewater for producing recycled construction material in Maribor, Slovenia**

The pilot demonstrates the usability of harvested rainwater and treated wastewater for the production of secondary raw materials (SRM) based construction products. Rainwater is harvested on site and stored in an underground reservoir, whereas reclaimed wastewater is transported from the nearby wastewater treatment plant and stored in a second reservoir. Both water flows are mixed and used for the production process in a mobile onsite plant.

**Pictures:** storage tanks, equipment shaft and pipeline during installation works before backfill and a location site<sup>6</sup>



<sup>6</sup> Photos: Aleš Erker, Maribor Water Supply Company



### Outputs:

- Harvested rainwater
- Two underground cisterns for the storage of rainwater and treated wastewater
- Two booster pumps with corresponding piping network, shafts, filters, etc.
- Water metres.

### Challenges:

- The interdependency of the CWC project on the Cinderela Project (Horizon 2020 Circ-01-2016-2017), as regarding certain equipment and construction works was a challenge. This dependency involved the construction of the building, from where roof rainwater was to be collected, stored and used in the production process. Delay in the Cinderela project and some difficulties in coordinating the activities affected the implementation of this part of the pilot action. In the meantime, a temporary solution was found to collect surface runoff and water used to wash the concrete blocks produced on the building foundation (mobile onsite plant). A drainage was built to collect this water and store it in the underground cistern for reuse in the production process.

### Impacts:

- Increase rainwater retention on site
- Reduce stormwater flow and drainage on site and protect against flooding
- Preserve water resources and save drinking water
- Enhance and encourage the use of rainwater and treated wastewater in industrial processes.

### Monitoring results:

Samples taken from the construction material which was processed using recycled water and analysed according to SIST EN 1008 standard were tested for oils and fats, detergents, colour, settleable solids, suspended solids, smell, pH and chlorine and Sulphate contents. According to MBVOD and Nigrad, results have shown that treated wastewater is suitable for the manufacturing of SRM based construction products.

The Biochemical Oxygen Demand (BOD<sub>5</sub>) of the effluent from the treated wastewater reservoir was < 5 mg/l, thus meeting the requirements for service water for indoor use, such as for toilet flushing.



**PILOT INVESTMENT 4:  
Rainwater utilisation via rooftop rainwater harvesting serving rain gardens  
in Bydgoszcz, Poland**

The pilot demonstrates nature-based solutions (NBS) using rain gardens for onsite rainwater attenuation and retention at two selected locations in the Municipality of Bydgoszcz. The role of blue-green infrastructure in reducing runoff peak flow and volume and in relieving the local rainwater sewer is emphasised here. Decentralised rainwater management is demonstrated by harvesting rainwater from the roofs of buildings, which is fed into constructed rain gardens and/or infiltrated into the ground.

Picture: Location 1<sup>7</sup>



7 Photo: Jacek Cieściński, Bydgoszcz Municipal Waterworks



## Thematic Catalogue 1

Picture: Location 2<sup>8</sup>



### Outputs:

- Sealed and non-sealed rain gardens connected with a system of stone channels (Location 1)
- Sealed rain gardens in containers (Location 2)
- Rainwater barrels

### Challenges:

- A challenge was to find the appropriate site for Location 2 for the implementation of NBS measures
- Lack of regulations and standards for the construction of rain gardens in Poland
- Lack of products for the monitoring activities on the local market

### Impacts:

- Improve rainwater management in buildings and protect their foundations against floods
- Reduce load on rainwater sewer
- Enhance groundwater recharge
- Enhance evapotranspiration and improve air quality and urban microclimate
- Enhance amenity and biodiversity
- Improve governance and citizens' participation and awareness
- Provide knowledge and promote uptake of innovative rainwater measures by demonstrating NBS in public buildings.

### Monitoring results:

Monitoring activities were undertaken at 3 locations: Locations 1 and 2 and the Municipal Waterworks Headquarters at Torunska Street. Rainwater samples were collected from the roof surfaces of the buildings at the outlet of the downpipes and analysed for their physico-chemical and microbiological quality.

8 B. Katarzyna Napierata, City of Bydgoszcz.



## Thematic Catalogue 1

The following quality parameters were measured: Total Suspended Solids (TSS), Biochemical Oxygen Demand (BOD5), Oxygen concentration, Dissolved organic Carbon (DOC), pH, Conductivity, Polycyclic Aromatic Hydrocarbons (PAHs), coliforms, E. coli and enterococci.

Additionally, automatic monitoring of soil moisture measurements is conducted at Location 2 during rainy and dry periods to assess plant health and growth conditions, using a weather station and four soil moisture sensors.

For the rainwater quality, the parameters tested showed good results. E. coli was always less than 1,000 CFU/100 ml and 4 out of 6 samples measured intestinal enterococci > 330 CFU/100 ml.

This is not in accordance with the EU Directive for Bathing Water but better than the requirements for reclaimed water for agricultural irrigation (Class C) according to the EU Regulation on minimum requirements for water reuse<sup>9</sup>. This is sufficient for the use purposes set in this pilot.

The automatic monitoring station was commissioned on 25th of April 2022 taking rainfall (mm) and soil moisture (m<sup>3</sup>/m<sup>3</sup>) measurements in two of the ten rain garden containers, with measurements taken at 5-minute intervals. No rainfall was recorded from 25th to 28th of April this year. In the following days, a gradual decrease in soil moisture was observed in the containers.

<sup>9</sup> <https://eur-lex.europa.eu/legal-content/EN/TXT/?uri=CELEX%3A32020R0741>



### PILOT INVESTMENT 5:

#### Demonstrating water consumption via smart metering and developing a supportive mobile application in Split, Croatia

The pilot demonstrates real-time water consumption at three different locations in a public building (University of Split) using wireless technology and the development of a mobile application to monitor and analyse water consumption, in order to achieve a higher water efficiency in the building and raise awareness towards sustainable water use. The data is publicly displayed on an LCD monitor at the entrance of the building as well on mobile applications. Faculty students and employees are able to download the data and analyse it. LoRaWAN offered the most reliable coverage among the 3 tested IoT radio technologies.

Picture: Faculty building - pilot site and application architecture<sup>10</sup>



#### Outputs:

- Three smart water meters based on LoRaWAN radio technology
- LCD screen at the entrance of the public building showing water consumption and other data
- Mobile application to measure water consumption data and other parameters for staff and students

#### Challenges:

- Continuous updates of the IoT Wallet services were required

#### Impacts:

- Increase public awareness for rational water use and water conservation
- Potential water saving effects
- Promote smart water metering technologies and their benefits
- Educational effects shared by faculty students and staff through continuous monitoring and application updates

#### Monitoring results:

Water leaks have been detected during operation of the system using the three smart water metres. Potential water savings made during the monitoring periods still need to be extrapolated and evaluated.

<sup>10</sup> Photo: Faculty of Civil Engineering, Architecture and Geodesy, University of Split



## Thematic Catalogue 1

**Monitoring activities performed from 01.03.2021 are divided into several groups:**

1. Technical maintenance of the system which involved:

- a) Major software updates of the IoT Wallet system
- b) Continuous monitoring of the system functions including hardware performances, which required replacements due to the bug in water-metres

2. Dissemination activities for the purpose of raising awareness:

- a) Data was analysed by scientific personnel and contributions were peer-reviewed and accepted as a scientific paper in the 6th International Conference on Smart and Sustainable Technologies (SpliTech 2021), September 08-11, 2021. Preliminary analyses gave indications on peak hours of water consumption, as well as leaks in every building block. It was shown that building blocks B and C have smaller losses due to the newly installed pipes with a higher quality.
- b) During the spring semester at the Faculty of Civil engineering, Architecture and Geodesy, 20 graduate students enrolled at “Hydrotechnical Systems” course and took data for its analysis. Students enrolled at undergraduate study course “Water Supply and Sewerage Systems” will have the same opportunity.



## SUMMARY OF LESSONS LEARNED

Depending on the different basic conditions of a specific location, appropriate solutions for decentralised, sustainable and resilient circular water reuse systems (e.g. rainwater harvesting and greywater recycling) can differ significantly. Table below presents a summary of lessons learned by the pilot partners during the different phases of pilot implementation, using different measures in the background of different local conditions and requirements.

**Table:** Summary of lessons learned during the piloting process

SUMMARY OF LESSONS LEARNED
A good planning, preparation and project management are key factors to successful implementation. Changes (technical, organisational, etc.) should be possibly kept to a minimum
Presence/lack of guidelines and technical standards on circular water use (CWU) can act as driver/barrier to implementation and dissemination of water reuse projects
Public tenders and procurement procedures demand a long time, which need to be simplified and updated in accordance with EU law, as already requested by the European Commission within the framework of NextGenEU
Policy makers should be involved at a very early planning stage of the project in order to avoid long decision-making process and delays in the implementation
Good and transparent communication and information flow among all pilot participants are essential for a flawless, successful and timely implementation
Shortage/lack of products on the local market for rainwater and greywater recycling systems is a barrier for a quick implementation, also connected with higher prices as a result of the COVID-19 pandemic
Lack of companies with specific knowledge, experience and references on greywater reuse and rainwater harvesting and the availability of construction companies can be a limiting factor for implementation
It is generally more difficult and costly to realise projects in existing buildings than in new ones. Therefore, it is imperative to implement circular water solutions in new building projects
Site inventory, especially when dealing with underground infrastructure need to be conducted at an early planning stage to avoid problems and unpleasant surprises during construction
With already existing buildings, the extent of the retrofit work cannot be estimated at an early project phase. Therefore, it is advisable to foresee a flexible budget (at least $\pm 20\%$ ) for future retrofit projects, which should better fit the site's upgrading needs
The long-term, successful operation of the pilot beyond the lifetime of the project should be ensured at an early phase including capacity training measures for operation and maintenance
The low prices for water and high infrastructure costs, or a combination of both, make it difficult to achieve a return on investment (ROI) in projects related to circular water management. Making prices transparent and understanding the true costs of water in business processes is fundamental to successfully reduce water consumption and promote water recycling and reuse
Lack of awareness can be a barrier and can lead to missed opportunities. There is a need to raise awareness amongst engineers, urban planners, designers and decision makers, but also amongst the general public about the potentials and benefits of CWU
The interdependency of one project's activities on another project's progress should be well coordinated at an early stage to avoid delays in implementation
NBS are easy to implement and their positive impacts can be directly mediated to the public and other stakeholders





### GENERAL EVALUATION OF THE CWC PILOT ACTIONS

Water-relevant planning must take place at the very beginning concurrently with the development of the site, which usually extends over a longer time period. None of the 5 pilot projects were implemented at a new construction site, but each time the existing building was used, which posed further challenges.

Different CWU measures were adopted with in the different FUAs and under different boundary conditions. The smart metering system implemented and tested in Split can be transferred to all other FUAs and applied in different sectors and at different levels (municipality, waterworks, household level, industry, etc.) in order to improve water efficiency and increase awareness on the conscientious use of the water resources.

The rain gardens in Bydgoszcz and Zugló are found in a location open to the large public. The location and good design should promote imitation and implementation of similar and other measures and increase awareness to NBS. More greenery in the city, especially near to the ground, creates a favourable urban microclimate and should therefore be increasingly implemented. De-sealing of surfaces will increase the infiltration potential, reduce floods and counter impacts of heavy rains on infrastructure and environment.

A step further was taken in Turin, where the extensive green roof and terrace design offer an additional amenity benefit for a broad public. Rainwater is fully utilised on site by the implemented measures, such that no rainwater enters the rainwater sewer. Moreover, rainwater is also used for urban farming at a small scale to show the benefits of reusing rainwater in different settings. Water recycling using rainwater and treated wastewater in the building construction sector was implemented in Maribor with demonstrably positive results. This can play a role model to other industries and sectors and encourage water recycling and reuse, where drinking water quality is not mandatory for the production process.

Altogether, we are at the very beginning of a positive development to understand how to deal with rainwater and wastewater as a resource for new water, nutrients and energy and recognise the broad application potential. All implemented CWC pilots act as demonstration sites to show the wide potential and many benefits of rainwater harvesting and water recycling.

#### Proposals for adjustments and improvements

Proposals for adjustment and improvements in the demonstrated pilots, which have been largely undertaken by the partners, have been made during the mentoring process (reports) and are presented here in brief.

#### ZUGLÓ PILOT

- It was proposed to install the drinking water backup system in such a way, that no backflow from the sewer can take place at any time
- To protect the pumps from running dry it is advisable to install filling level sensors to detect the water level in the cisterns at all times
- Labelling of all pipes and use taps is essential to distinguish between potable and non-potable water networks and avoid misuse.



## Thematic Catalogue 1

### TURIN PILOT

- Proper maintenance is indispensable for a long-term and successful operation of all implemented measures. For this purpose, qualified personnel should be trained for operation and maintenance and Turin Municipality will be responsible for this service
- Proper designation and labelling of all pipes, tapping points and plant components is necessary to differentiate between potable and non-potable water networks
- Backup water supply (drinking water) should be designed according to technical standards to ensure that there is no cross-connection between the drinking water and the non-potable water networks at any time.

### MARIBOR PILOT

- It was proposed to harvest rainwater from the paved traffic surfaces, in addition to the roof runoff, in order to augment the amount of rainwater made available for the production process. In this case, the installation of a filter/sieve or a pre-sedimentation stage for the reduction of particulate matter in rainwater is necessary. This has been already executed at a later stage of the pilot implementation
- Overflow from the underground reservoirs is discharged into an infiltration trench built on site. In this case, it should be ensured the onsite infiltration of treated wastewater is in accordance with the local environmental regulations.
- Once the utility building is completed, project partners plan to use rainwater to flush the toilets. In this case, a standard drinking water backup system will be required in order to ensure a continuous water supply for toilet flushing, especially when the water reservoirs are empty.
- It is advisable to take water samples for quality measurements at the point of use, i.e. from the underground cisterns. This reflects best the real quality of the stored water used in the production process
- The considerably high turbidity of the treated wastewater should be possibly less than 2 NTU, when recycled water is used for toilet flushing. Values exceeding 2 NTU can lead to deposits on water fixtures and/or odour nuisances. However, the high turbidity measured as suspended solids should have no negative impact on the production process itself. Nevertheless, it would be important to monitor the rainwater and treated wastewater quality in the cisterns over a longer time.

### BYDGOSZCZ PILOT

- Rain gardens are flexible NBS measures for rainwater retention and treatment if enough space is available. Therefore, urban planners and designers have broad design options which can be exploited in future projects
- Since a rainwater fee is levied by the Municipality of Bydgoszcz for the amount of rainwater entering the rainwater sewer, studies should be conducted in the future on the impact of the implemented rainwater measures on reducing the rainwater fees for the Waterworks Museum location. Calculations have not been made yet to determine the level of fee reduction. Therefore, it is recommended to follow up on this topic, since the financial benefits of these measures, besides the social and environmental ones, can also be of significance
- An important factor for a successful and long-term operation of rain gardens is a regular maintenance to detect any blockages and remove litter and excess soil. Clearing of inlets, outlets, and overflows, cutting back and trimming are also required. Rain garden plantings require care and watering until they are established, generally the first 1-2 years after construction.



### VIK-SPLIT PILOT

- The implemented smart metering system can be developed further and extended to other sectors, such as the water utility sector, where employees, for example, no longer need to enter the property or a building to read the water metres and invoice the tenants' water consumption. Further information can be also provided, for example, on water consumption peaks or water leaks and on optimising the water supply network. The application field offered by this system is broad and can increase the water efficiency and use
- Other applications are also conceivable, for example, if the individual water consumption data under a different setting (e.g. apartments in a multi-storey building or hotel rooms) were to be recorded with the aim of monitoring the water consumption to induce a change in user behaviour and raise awareness towards water saving
- A longer monitoring period is also required to evaluate more water consumption data which can provide information on any change in the consumption behaviour and awareness towards water use and water saving at the Faculty.

### Monitoring results

Monitoring activities over a period of at least one year are necessary in order to reach a comprehensive assessment of the pilot and be able to measure some impacts. For a variety of reasons such as the Covid-19 pandemic, short project duration (3 years), administrative restrictions and delays, lack of rain, this could not be achieved during the project lifetime.

Not all monitoring activities have been conducted yet and thus a final and conclusive evaluation will not be possible. Although the pilot plant in Turin was completed some time ago, no monitoring was yet possible due to the simple reason that it did not rain for several months in Turin. The scarce rainfall in Bydgoszcz and Zugló in the months following pilot implementation has also been a challenge and caused delays in the planned monitoring activities.

To determine the quantitative impact on relieving the load on the sewage system and the reduction in the drinking water consumption, a monitoring plan over several years will be necessary and which will also allow for some technical optimisation. For such activities, public financial reserves should be made available beyond the project's lifetime.

As far as the quality regulations for non-potable water are concerned, some uncertainties arose during the pilots' implementation. Drinking water quality is not required for every application. Water quality requirements for water reuse should be based on the type of application to ensure that there is no hygienic risk (and no loss of comfort) for the users. For many applications, the quality requirements of the EU Directive for Bathing Water have proved to be adequate for uses, which do not require a drinking water quality. These guidelines are followed in Germany since 1995 with a very good experience and results which also guarantee a high and safe service water quality for reuse.

Based on the monitoring results available so far, there is no evidence that a hygienic risk for users is to be expected. This assumes that the pilots will continue to be professionally monitored and maintained in the future.



## SUMMARY OF JOINT CONCLUSIONS ON PEER-REVIEW VISITS

All applied measures in the 5 CWC pilots can be implemented and adapted in the other FUA's, as has also been communicated and concluded from the peer-review visits with more or less restrictions and obstacles as pertaining to the specific local conditions and to policy framework and requirements.

**Table:** Summary of joint conclusions by partners on pilots resulting from the peer-review visits.

SUMMARY OF JOINT CONCLUSIONS ON PEER-REVIEW VISITS
Partners recognise a great potential for the implementation of similar solutions in their countries in public institutions such as government buildings, Kindergarten, schools, sports facilities, state-owned enterprises and public urban spaces, but also at the household level. This will raise awareness towards water recycling and reuse and increase public acceptance
Lack of strategies and policy instruments (regulations and standards) for rainwater management and water reuse is a barrier towards implementation
Funding and political will are prerequisites for implementation of CWU projects
It is important to show successful case studies to convince and engage stakeholders, especially authorities and policy makers
Innovative solutions and successful projects also need to be presented and made known to the private building investment sector and the wide public to promote CWU
There is a need to promote national and local incentives and programmes (subsidies, rainwater fees) for onsite rainwater management and water reuse, especially for private households and home owners
Generally, there is low awareness, knowledge and interest for water saving and efficiency by residents and public investors and lack of understanding for new solutions. A lack of data showing the need and opportunities to reduce, reuse and recycle water often makes this barrier more difficult to overcome
Consideration of rainwater retention solutions by designers is still low and inadequately understood
There is a need to raise awareness amongst engineers, urban planners, designers and decision makers about the potentials and benefits of circular water use to be integrated in the spatial planning and urban and landscape design of climate resilient cities
Implementation of these measures in new buildings is easier than in already existing buildings (dual-pipe network needed for water reuse)
The rising energy and water prices and future water scarcity scenarios highlight the importance of CWU and increase the trend towards water reuse
Stakeholder engagement is an important factor in bringing about knowledge and in developing local visions and strategies to foster urban circular water use
The trends in prices and legal requirements are similar in the CE region

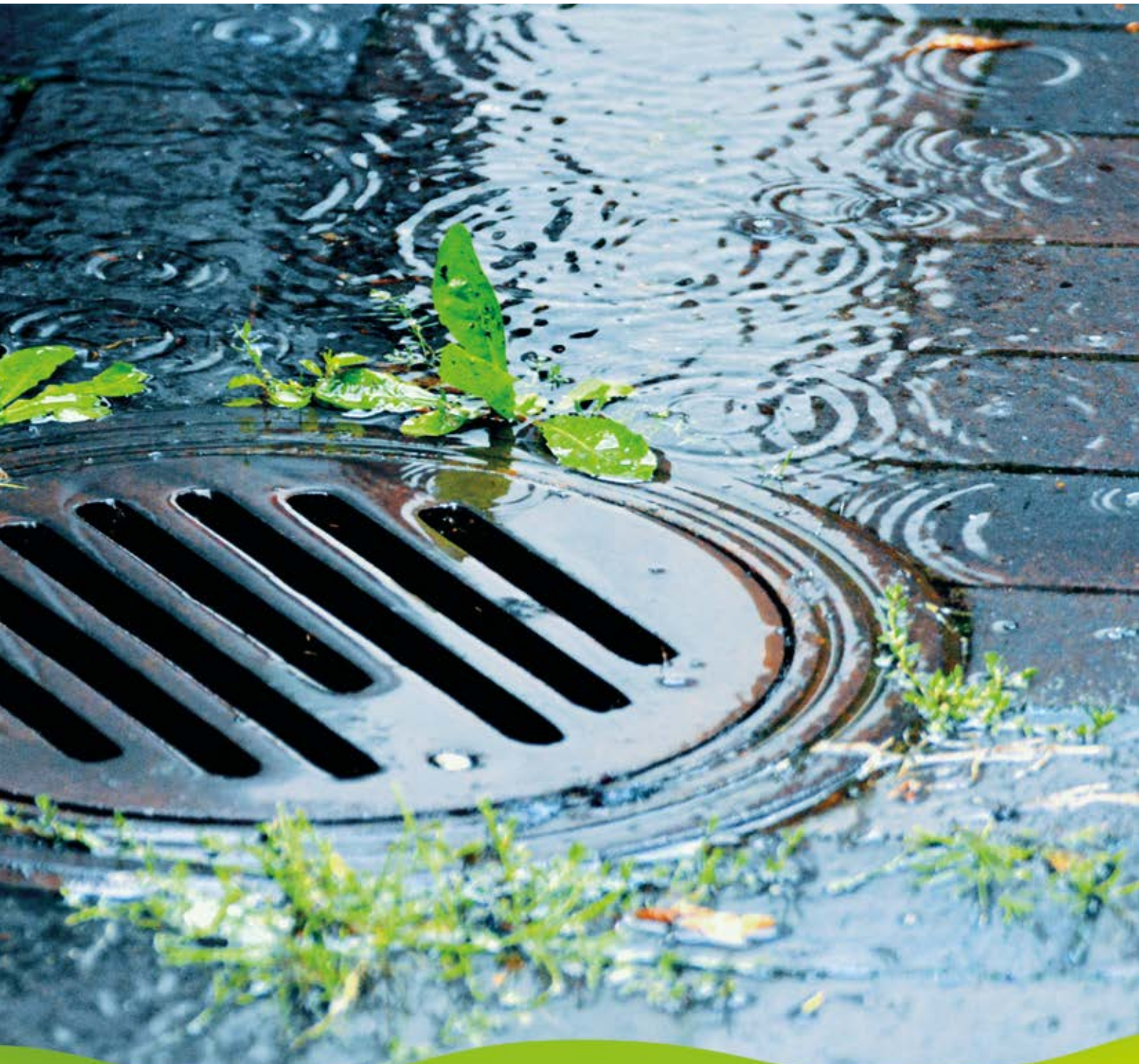

Thematic Catalogue 2

# Innovative engineering and nature-based solutions for circular water usage



# Content | Part 1: Rainwater Management

<b>1. INTRODUCTION</b>	<b>64</b>
1.1. ON CWC-CATALOGUE 2	65
1.2. CIRCULAR WATER MANAGEMENT	66
1.3. NATURE-BASED SOLUTIONS (NBS)	67
1.4. SUSTAINABLE URBAN DRAINAGE SYSTEMS (SUDS)	67
1.5. EUROPEAN POLICIES AND LEGISLATIONS	68
<b>2. TOOLS FOR SUSTAINABLE RAINWATER MANAGEMENT</b>	<b>69</b>
2.1. RAINWATER HARVESTING (RWH) FOR POTABLE AND NON-POTABLE REUSE	71
2.1.1. Rainwater harvesting (RWH) system components	71
2.1.2. Sizing of a RWH system	76
2.1.3. Operation and Maintenance	77
2.1.4. Uses and applications for harvested rainwater	77
2.1.5. Benefits	78
2.1.6. Performance	78
2.1.7. Costs	78
2.1.8. Hygienic aspects	79
2.1.9. Rainwater treatment for potable use in buildings	79
2.1.10. Normative standards	80
2.1.11. Rainwater harvesting for adiabatic cooling in buildings	80
2.2. RAINWATER RETENTION AND EVAPOTRANSPIRATION	81
2.2.1. Green roofs	81
2.2.2. Green walls/facades	83
2.2.3. Rain gardens (Bioretention systems)	85
2.2.4. Retention ponds	87
2.2.5. Free surface flow constructed wetlands	88
2.2.6. Subsurface flow constructed wetland	90
2.2.7. Detention basins	91
2.3. INFILTRATION	93
2.3.1. Permeable / porous paving	95
2.3.2. Filter strips	98
2.3.3. Swales (vegetated swales / bioswales)	99
2.3.4. Infiltration basins	100
2.3.5. Infiltration trenches	102
2.3.6. Swale-trench infiltration	104



<b>3. OVERVIEW MATRIX OF DIFFERENT RAINWATER MANAGEMENT MEASURES</b>	<b>106</b>
<b>4. BEST PRACTICE</b>	<b>108</b>
4.1. RAINWATER HARVESTING BELSS-LÜDECKE RESIDENTIAL AREA, BERLIN	108
4.2. POTSDAMER PLATZ, BERLIN	110
4.3. OLYMPIA STADIUM, BERLIN	113
4.4. BERLIN-BRANDENBURG INTERNATIONAL AIRPORT (BBI)	114
4.5. HAMBURG WATER CYCLE® (HWC)	115
4.6. EMSCHERGENOSSENSCHAFT	117
4.7. KURAS - CONCEPTS FOR URBAN STORMWATER MANAGEMENT, DRAINAGE AND SEWAGE SYSTEMS	118
4.8. THE GORLA MAGGIORE WATER PARK (COMBINED SEWER OVERFLOW TREATMENT)	118
4.9. RETENTION SOIL FILTER (RSF) SYSTEM AT BERLIN-ADLERSHOF	122
<b>5. ADDITIONAL BIBLIOGRAPHY</b>	<b>123</b>



# 1. Introduction

By 2030, the world may face a 40% gap in water supply vs. demand. At the same time, 80% of wastewater currently goes back into the environment untreated<sup>1</sup>. Therefore, it is high time to explore circular water management solutions and develop a closed loop system with optimal reuse to prevent these valuable resources from being lost.

The conventional, centralised model of urban water management faces multiple challenges mainly due to problems linked to aging, oversized and expensive infrastructure, weak governance structures and limited investment opportunities for new infrastructure projects. There is also a rapid change in the water availability setting driven by climate change. This path of the conventional urban water management comes at a high cost of social and ecological degradation and high capital investment. Urbanisation alters the natural landscape and affects the natural water cycle, usually maintained in balance through several hydrological processes such as evaporation, precipitation, infiltration and transpiration by plants. Through the increased sealing of permeable surfaces as a result of construction activities, the soil permeability is reduced as well as the amount of water that infiltrates into the ground, thus affecting the whole water balance. The increase of impermeable surfaces will contribute to higher volumes of stormwater runoff, resulting in increased urban flooding and pollution of surface water bodies (Figure 1).

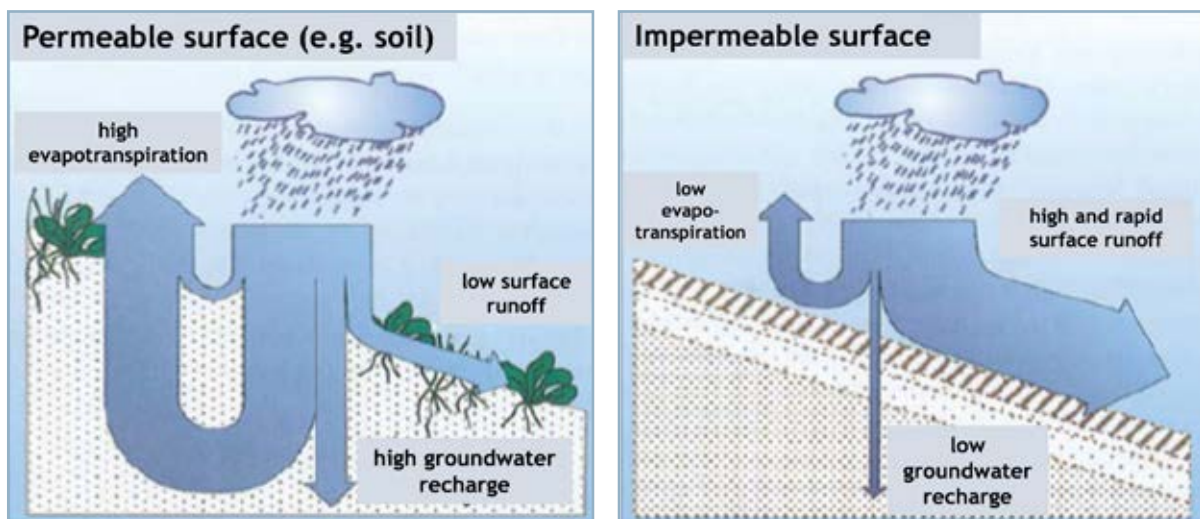

Figure 1: Change in water runoff volume as a result of urbanisation<sup>2</sup>.

Water scarcity in urban areas, also intensified by climate change, exert negative impacts on the urban ecosystem leading to a drop in the groundwater table, urban heat island effects, increased demand for long-distance water supply and peak consumption periods, especially during the summer months, only to mention a few.

1 Connor, R., Renata, A., Ortigara, C., Koncagül, E., Uhlenbrook, S., Lamizana-Diallo, B.M., Zadeh, S.M., Qadir, M., Kjellén, M., Sjödin, J. and Hendry, S. (2017) The United Nations world water development report 2017. Wastewater: The untapped resource. The United Nations World Water Development Report

2 Dezentrale naturnahe Regenwasserbewirtschaftung (2006) Freie und Hansestadt Hamburg. Behörde für Stadtentwicklung und Umwelt. <https://www.risa-hamburg.de/fileadmin/risa/Downloads/Dezentrale%20naturnahe%20Regenwasserbewirtschaftung.pdf>





## Thematic Catalogue 2 - PART 1

Instead of using distant water resources, ways should be found to best allocate water resources to meet human needs. Part (if not all) of the water demand may be supplied by a stock of local water sources including rainwater, wastewater and greywater. These local water sources had been traditionally treated as “wastewater” in urban areas and eventually drained into the public sewer.

The use of local water resources is also linked with the existing debate on urban sustainability, which recognises the importance of local solutions and the key role of local governments and citizens in search of sustainable development. This principle has been put into practice in Europe and elsewhere based on the local Agenda 21 and the Sustainable Development Goals (SDG, 2015)<sup>3</sup>.

Another major concern of conventional water management in urban areas is the rapid drainage of rainwater via the combined sewer system, resulting in increased hydraulic load on the wastewater treatment plants and a deteriorating quality of surface water bodies. Against this background and the requirements of the EU Water Framework Directive (WFD, 2000)<sup>4</sup> to achieve good water status, a separate discharge of rainwater and wastewater should be sought.

### 1.1. On CWC-Catalogue 2

Countries of Central Europe vary considerably in the availability of water and management of their water resources. Several CE regions and cities also exhibit high levels of water losses in their centralised water supply networks which may reach up to 50%. Therefore, there is an urgent need to consider new and innovative water management schemes in face of the persisting, negative impacts of climate change and urban development. Rainwater harvesting and water reuse should become an integral part of overall water management schemes in these countries to ensure water supply, preserve the precious water resources and protect the ecosystem.

This CWC-thematic catalogue for innovative engineering and Nature-Based Solutions (NBS) provides authorities, planners, land developers, engineers, property owners and other stakeholders with information on the state-of-the-art technology on sustainable rainwater management and greywater reuse within an urban context. It serves as a tool and offers guidance on selecting the appropriate rainwater management scheme/greywater reuse technology for a specific site.

The catalogue aims at supporting decision makers in moving towards a more decentralised approach to manage water resources and come closer to achieving the Sustainable Development Goals (SDG) and a higher water self-sufficiency.

The catalogue is divided into two major parts dealing with: 1) sustainable tools for rainwater management and 2) tools for greywater recycling and reuse.

**In this catalogue, the terms rainwater and stormwater will be used interchangeably.**

<sup>3</sup> <https://www.un.org/sustainabledevelopment/sustainable-development-goals/>

<sup>4</sup> WDF - “Directive 2000/60/EC of the European Parliament and of the Council establishing a framework for the Community action in the field of water policy”



## 1.2. Circular water management

A new circular path of water is envisioned as an alternative or supplement to the conventional linear model offering decentralised water management options which can be applied at different spatial levels. Therefore, the aim of circular water management is to use wastewater as a resource (for water, energy and nutrients) in line with the circular economy (CE) concept and based on the following order of priority:

- Avoid (if possible)
- Reduce
- Recycle
- Reuse
- Dispose (if must be).

Existing water and wastewater infrastructure in most industrialised countries is not adequate to support a circular water economy. This needs to be optimised to decrease water losses and new water infrastructure needs to be designed to promote circular water practices. Rainwater and wastewater are valuable resources for water, energy and nutrients which can be collected, treated, recycled and reused to close the water cycle and pave the way towards a circular water economy in Central Europe and elsewhere (Figure 2).

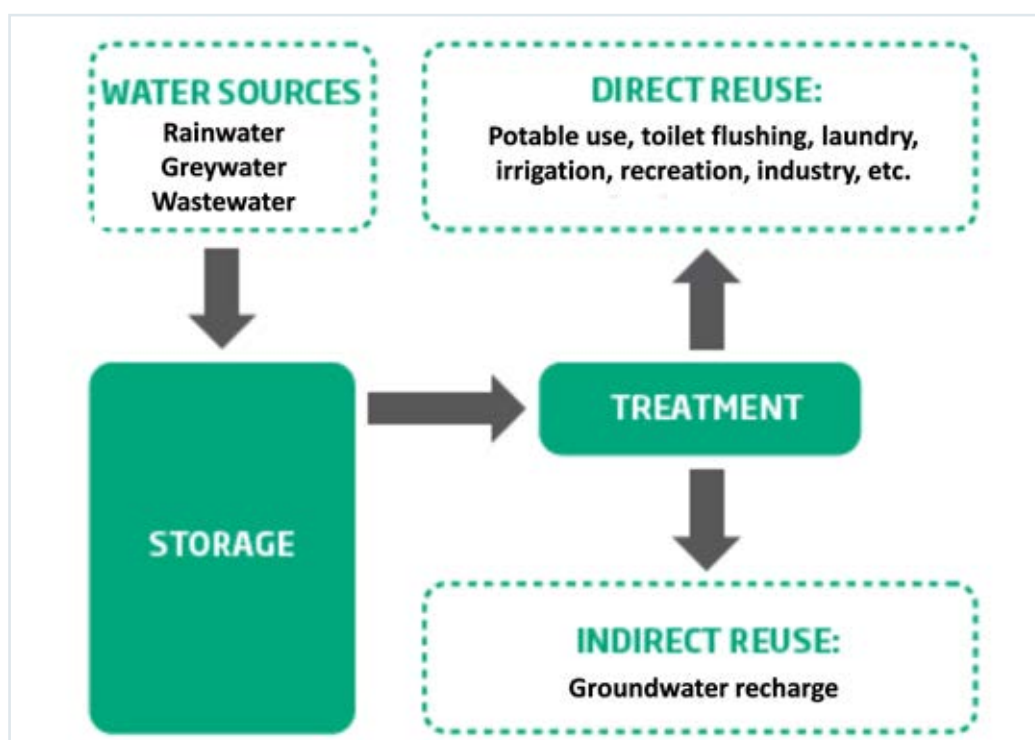

Figure 2: Fate of water resources in a circular water management (Adapted from Hoffmann et al. 2015)<sup>5</sup>.

<sup>5</sup> Hoffmann, B., Laustsen, A., Jensen, I. H., Jeppesen, J., Briggs, L., Bonnerup, A., Hansen, L., Sommer Lindsay, R., Rasmussen, J., Andersen, U. R., Rungø, M., Uggerby, M., Bay, H., Quist Rasmussen, S., Vester, M., Riise, J. C., Krag Strømberg, C., Dreiseitl, H., Astrup, R., ... Milert, T. (2015) Sustainable Urban Drainage Systems: Using rainwater as a resource to create resilient and liveable cities. State of Green <https://stateofgreen.com/en/news/new-white-paper-on-climate-adaptation-launched-at-aquatech>



### 1.3. Nature-Based Solutions (NBS)

The EU<sup>6</sup> defines Nature-Based Solutions (NBS) as “solutions that are inspired and supported by nature, which are cost-effective, simultaneously provide environmental, social and economic benefits and help build resilience. Such solutions bring more diverse, nature and natural features and processes into cities, landscapes and seascapes, through locally adapted, resource-efficient and systemic interventions.”

Approaches to NBS are generally classified into 5 categories<sup>7</sup>:

- Ecosystem restoration approaches (e.g. ecological restoration, ecological engineering and forest landscape restoration)
- Ecosystem-related approaches (e.g. ecosystem-based adaptation, ecosystem-based mitigation, and ecosystem-based disaster risk reduction)
- Infrastructure-related approaches (e.g. natural infrastructure and green infrastructure approaches)
- Ecosystem-based management approaches (e.g. integrated coastal zone management and integrated water resources management)
- Protection approaches (e.g. area-based conservation approaches including protected area management).

Examples on NBS include green roofs and facades, rain gardens, ponds and wetlands, among other measures.

### 1.4. Sustainable Urban Drainage Systems (SUDS)

Sustainable Urban Drainage Systems (SUDS, UK), also known as Stormwater Best Management Practices (BMPs, North America), Water Sensitive Urban Design (WSUD, Australia) or Decentralised Stormwater Management (Germany), are systems which manage urban rainwater/stormwater, replicate natural processes and attenuate stormwater flow within urban catchment areas<sup>8</sup>. These measures primarily intercept runoff and protect water resources and the environment by promoting rainwater harvesting at source, the temporary storage of water (retention), infiltration and evapotranspiration, usually in combination or in a series of components to form a “management train”, depending on site conditions and local requirements.

Traditionally, stormwater is drained as quickly as possible from urban areas into receiving water bodies. Sustainable stormwater management approaches see rainwater as a valuable resource. Therefore, the SUDS concept aims at<sup>9</sup>:

- using rainwater as a resource (e.g. as drinking water alternative, for toilet flushing, irrigation, laundry, industry, etc.)
- retaining rainwater on site and managing it aboveground, if possible close to where rain falls
- recharging groundwater by promoting rainwater infiltration
- promoting evapotranspiration and improving the micro-climate

6 <https://ec.europa.eu/research/environment/index.cfm?pg=nbs>

7 <https://portals.iucn.org/library/node/46191>

8 Fletcher, T.D., Shuster, W., Hunt, W.F., Ashley, R., Butler, D., Arthur, S., Trowsdale, S., Barraud, S., Semadeni-Davies, A., Bertrand-Krajewski, J.L. and Mikkelsen, P.S., 2015. SUDS, LID, BMPs, WSUD and more. The evolution and application of terminology surrounding urban drainage. *Urban Water Journal*, 12(7), pp.525-542

9 The SuDS Manual. Department for Environment Food and Rural Affairs. CIRIA 2015



## Thematic Catalogue 2 - PART 1

- slowing and storing runoff to mimic natural runoff rates and volumes
- filtering and treating runoff through natural soil filtration
- if necessary, throttle into a water body or discharge into the sewer.

SUDS achieve an optimal decentralised management of surface water runoff by rebuilding the natural hydrological cycle taking into account the following four pillars:

- Water quantity: reduce the rate and quantity of rainwater discharge via rainwater harvesting, infiltration, retention and conveyance
- Water quality: improve the quality of rainwater discharges and the receiving water bodies. This is achieved through sedimentation, filtration, adsorption, biodegradation, plant uptake, etc.
- Amenity: improve living environment
- Biodiversity: enhance biodiversity of wildlife and plants.

### 1.5. European policies and legislations

Some of the European level policies and regulations offer legislative boundary conditions for urban stormwater management. These include:

- Water Framework Directive 2000/60/EC (WFD)
- Groundwater Directive 2006/118/EC (GWD)
- Floods Directive 2007/60/EC (FD)
- Marine Strategy Framework Directive 2008/56/EC
- Urban Wastewater Directive (91/271/EC)
- Environmental Quality Standards Directive (2008/105/EC) (EQSD)
- Bathing Waters Directive (2006/7/EC).

The Water Framework Directive 2000/60/EC (WFD) forms the heart of European Water Law. Its primary goals are the maintenance and improvement of the aquatic environment, reduction of discharge of hazardous substances in waters as well as the prevention of deterioration of waters.

The EU Flood Directive 2007/60/EC on the assessment and management of flood risks requires EU Member states to assess if their water courses and coastlines are at risk and subsequently take adequate and coordinated measures to improve flood risk management. The EU Groundwater Directive prohibits any actions that may deteriorate groundwater quality, possibly affecting the application of infiltration-based stormwater management practices.



## 2. Tools for sustainable rainwater management

There exists a wide array of technologies and measures to reduce and offset the impacts of stormwater and flood events on the environment and infrastructure. Rainwater can be infiltrated or harvested and stored for irrigation, greening or adiabatic cooling. Retention of rainwater in urban areas (ponds, wetlands) is a good measure to reduce peak discharges and increase evapotranspiration. The potential of sustainable rainwater management systems to adapt to various conditions and requirements is limitless. In addition, a balanced ratio of sealed to unsealed surfaces in urban areas should be always considered.

### Combined and separate sewer systems

In a combined sewer system, rainwater and wastewater are discharged into a common sewer, which usually drains into the wastewater treatment plant (WWTP). Since rainwater volumes often exceed the amounts of generated wastewater, it is technically and economically not feasible to treat the entire wastewater flow in the WWTP. Therefore, rainwater retention basins are usually used to reduce the hydraulic load entering the WWTP. The retained flow is eventually released, usually throttled, into a water body (Figure 3).

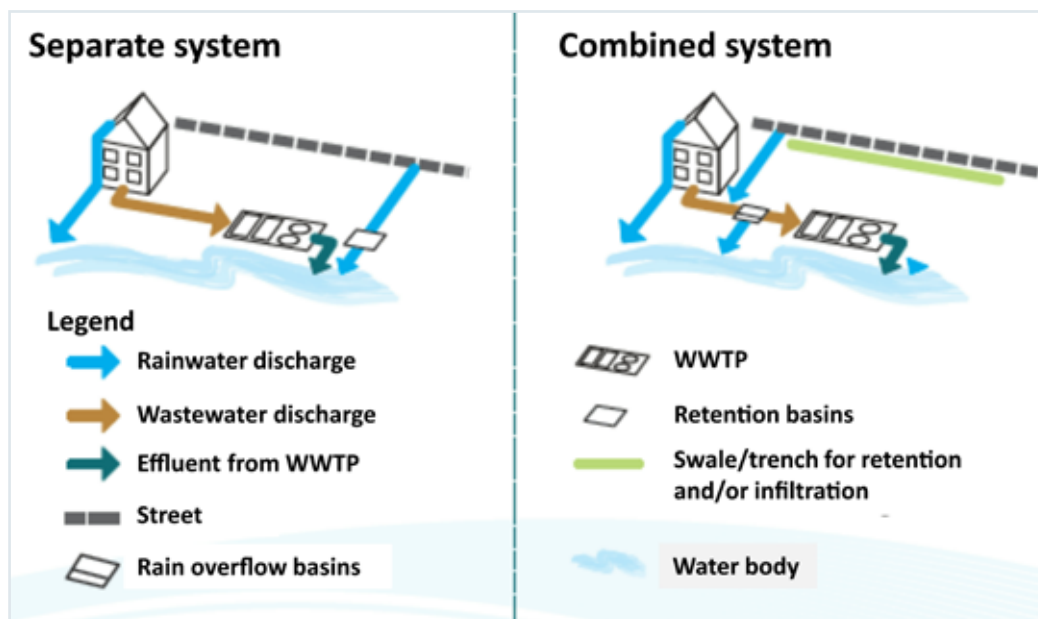

Figure 3: Process diagram of separate and combined sewer systems.<sup>10</sup>

In a separate sewer system, wastewater and rainwater are collected in two separate sewers, whereby wastewater is discharged into the WWTP and rainwater into the nearest water body (stream, river). The discharge of rainwater into a water body usually requires a permit. Retention basins are also used for the intermediate storage of rainwater, since the infiltration capacity of the soil is usually insufficient to reduce the surface runoff. In addition to reducing rainwater peak flows, retention basins effect some degree of runoff treatment via sedimentation.

<sup>10</sup> Geiger, W., Dreiseitl, H., Stemplewski, J. (2009) Neue Wege für das Regenwasser. Handbuch zum Rückhalt und z Versickerung von Regenwasser in Baugebieten. Emschergenossenschaft, Essen (Hrsg.). 3. Auflage, Oldenbourg Industrieverlag GmbH, München



The separate sewer system offers several advantages over the combined sewer:

- slightly polluted rainwater can be directly and cost-effectively collected and discharged into a nearby water body without treatment
- surface runoff can be managed separately without any contamination from sewage
- rainwater can be harvested and reused or infiltrated to recharge groundwater
- the size of the wastewater sewer can be designed to be small to treat only wastewater
- load on the WWTP is reduced
- the risk of sewage overflow can be limited or excluded.

Figure 4 presents a general approach proposal to sustainable rainwater management in urban areas, acting as a guide to the selection of the appropriate measure or series of measures for a specific site and local conditions.

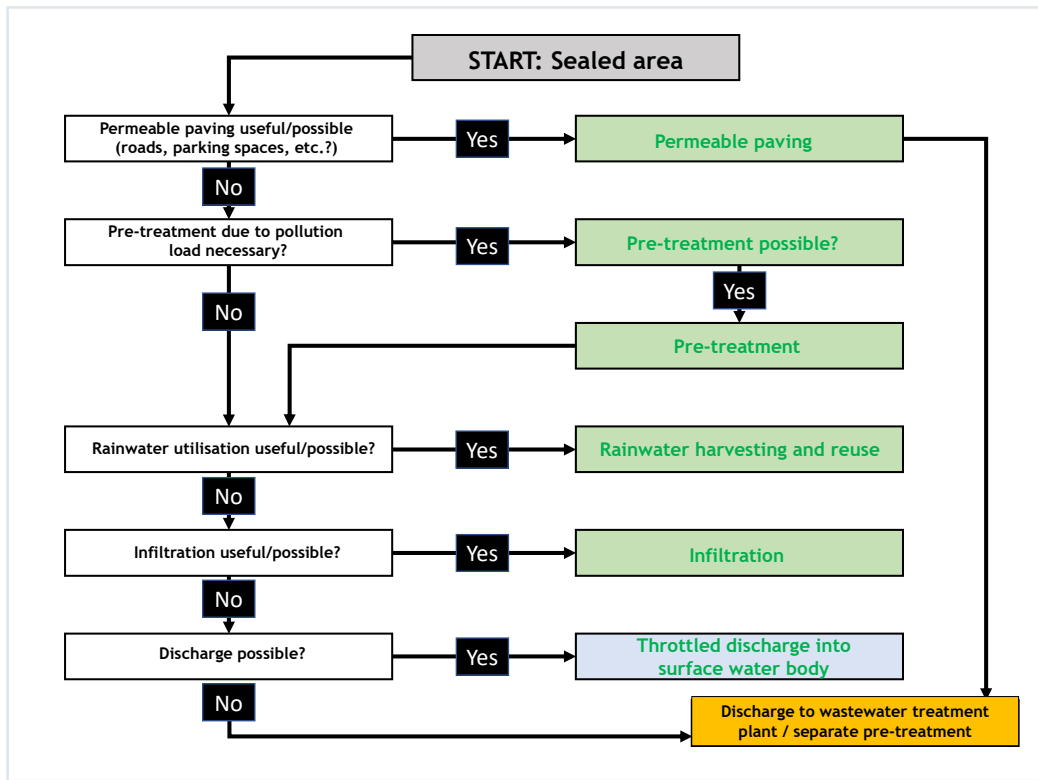

Figure 4: Check scheme for sustainable rainwater management in urban areas (Adapted from EmscherGenossenschaft).



## 2.1. Rainwater harvesting (RWH) for potable and non-potable reuse

Rainwater, as it comes out of the clouds, is distilled water with very low conductivity ( $0.05 \mu\text{S}/\text{cm}$ ), which is the sum parameter for the inorganic total dissolved solids (TDS) in rainwater. In comparison, drinking water exhibits typical conductivity in the range of  $200\text{-}800 \mu\text{S}/\text{cm}$ , while sea water about  $50,000 \mu\text{S}/\text{cm}$ .

Therefore, due to the very low mineral content of rainwater and at locations where drinking water is characterised by a high degree of hardness, rainwater is usually preferred for different applications in the private as well as industrial sector (e.g. laundry, gardening, boilers, cooling towers).

In general, rainwater is characterised by considerable spatial and temporal variability. Its quality is mainly dependent on the atmospheric pollution as well as the catchment area and the method of collection. Usually, industrial areas and areas with heavy traffic contribute to more polluted runoffs than less dense areas.

Rainwater quality is also influenced by the roof/surface type and material. For example, sloped roofs with smooth surfaces are preferred, as they accumulate less dust, whereas heavy metals can be washed out into the rainwater from unsealed metal roofs. Runoff from green roofs can be more or less brownish in color due to the soil substrate, which is unproblematic for irrigation purposes but less suitable when rainwater is used for laundry.

### 2.1.1. Rainwater harvesting (RWH) system components

Residential or commercial RWH systems vary widely in design from simple, small rain barrels at the end of a roof downpipe for garden irrigation, to advanced systems which purify water to potable water standards or larger systems for a whole district. Typically, a RWH system consists of three basic elements:

- **Collection system:** a catchment surface such as a roof or ground surface
- **Conveyance system:** which transports the rainwater, such as gutters and downpipes
- **Storage system:** such as rain barrels, cisterns or tanks, stored underground or above ground

Other RWHS components include:

- **Filters/inlet screening:** hold back debris from roofs and trees such as downpipe filters, pre-tank and in-tank filters, or a
- **First flush diverter:** a valve which diverts the first spell of rain (first flush), which is usually highly polluted, away from cistern
- **Calmed inlet:** into the cistern
- **Cistern overflow:** draining into an onsite infiltration or sewer system
- **Distribution system:** includes pipes, connections and expansion tank
- **Pump system:** with extraction device, delivering rainwater to the point of use
- **Dual-pipe system:** for indoor water use
- **Mains backup supply:** supplements water when harvested rainwater does not meet demand
- **Control panel:** shows fill level, drinking water backup, etc.

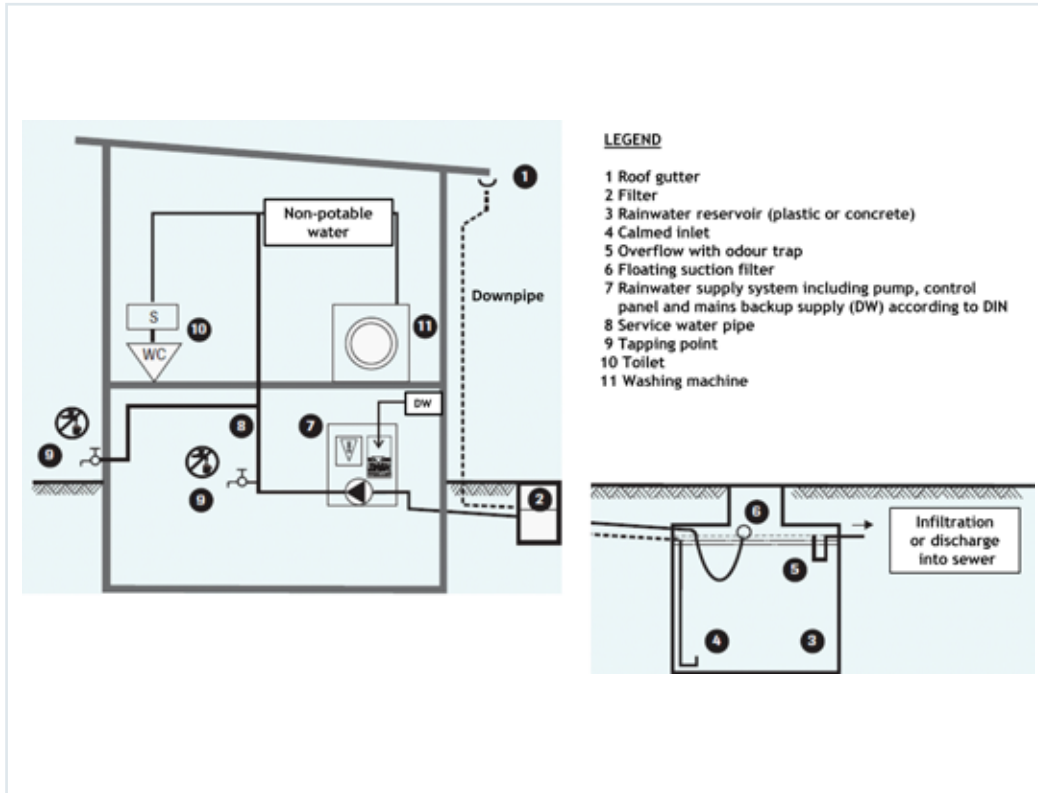

Figure 5: System components of a rainwater harvesting system (fbr).

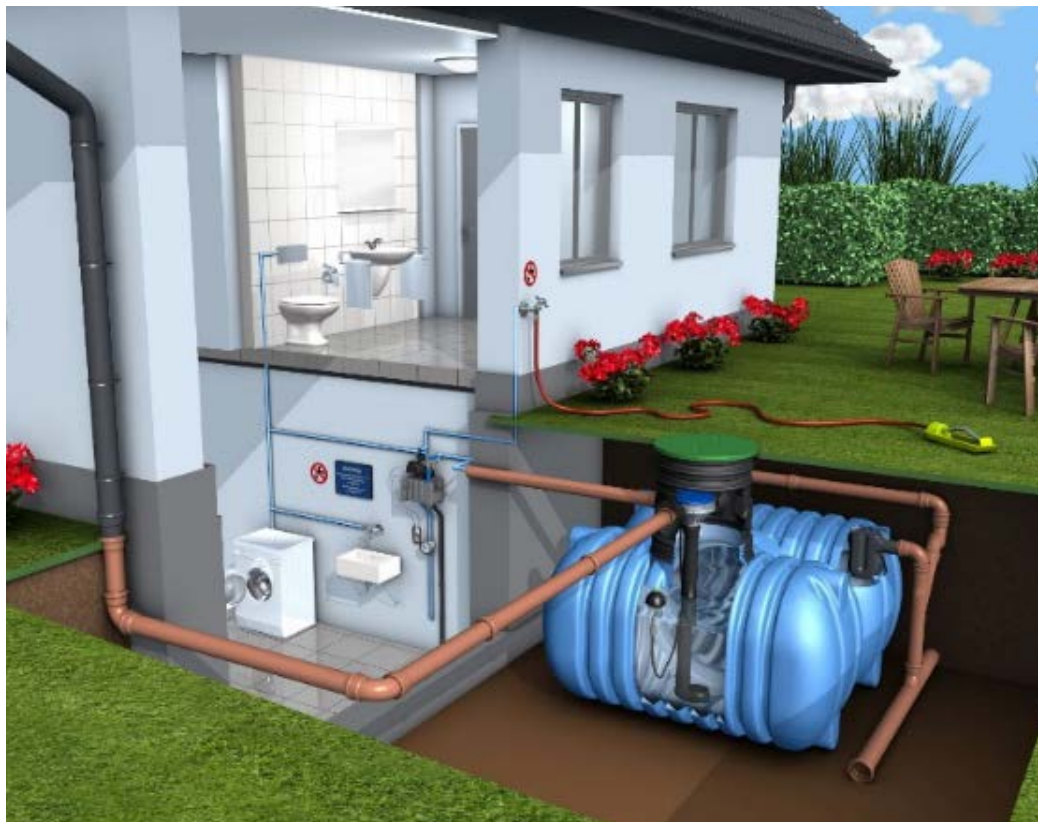

Figure 6: A schematic diagram of an underground rainwater cistern for indoor and outdoor water reuse (fbr).





### Collection system

Collection from roof surface is usually preferred to other surfaces, such as runoffs from streets, pavements, courtyards or other ground surfaces due to the generally lower pollution load of rainwater from roof runoffs. Collection from the roof surface is also preferred from slate, glass, concrete or clay tile roofs. Uncoated copper and zinc roofs may contribute to an increase in the concentration of metal ions in the runoff. Sealed metal roofs are also appropriate for rainwater collection.

### Conveyance system

Gutters and downpipes are traditionally the conveyance means for the transport of rainwater from roof surfaces into the cistern or collection tank. A useful rule of thumb is to make sure that there is at least 1 cm<sup>2</sup> of gutter cross-section for every 1 m<sup>2</sup> of roof area<sup>11</sup>. In order to prevent dust and debris from collecting in the cistern, the first spell of rain (first flush) should pass through a coarse filter or a first flush diverter.

### Storage system

Rain barrels are the most common means of harvesting rainwater for garden use, usually with a capacity of less than 1 m<sup>3</sup>. Cisterns and tanks have a larger storage capacity and can be placed above ground, at ground level or buried underground (Figure 7). They should be protected from light and preferably placed in a cool environment (underground, cellar) and cistern overflow can be infiltrated on site. Reinforced concrete and plastic (PE) sheets are most commonly used material for rainwater cisterns/tanks.

### Pump system

The supply pump can be submerged in the storage tank or installed dry in an operating room. Most available systems use automatic pressure and flow-activated pumps. When the toilet is flushed, the pump switches on and refills the toilet cistern. Alternatively, rainwater can be pumped to a header pump where it feeds the WC.

<sup>11</sup> Gould, J. and Nissen-Petersen, E. (1999). Rainwater Catchment Systems for domestic Supply. Design, construction and implementation. Intermediate Technology Publications, UK



Thematic Catalogue 2 - PART 1



Underground plastic cistern  
(GreenLife)



Underground concrete cistern  
(3 - 12 m<sup>3</sup>) (Mall)



Decorative cistern for  
garden irrigation (350 litres)  
(Otto Graf)



Retention cistern  
(20 - 100 m<sup>3</sup>) (GreenLife)



Reinforced concrete cistern  
(24 - 100 m<sup>3</sup>) (Mall)



Cellar storage tank  
(1,700 litres) (Otto Graf)

Figure 7: Different types of rainwater storage reservoirs.



Rainwater should be preferably pumped from the cistern using a floating suction filter (Figure 8) placed close below the water surface and not at the surface or bottom of the tank, in order not to stir any sediment.



Figure 8: Floating device with a suction pump delivering water to the different points of use.

The cistern volume can be divided into an **effective volume** (storage volume) and a **retention volume** to achieve a balance between water availability in the cistern (cistern should be possibly full at all times) and hydraulic relief of the sewer (throttled discharge) (Figure 9). A specific retention volume can be discharged into the sewer with a delay by means of a throttle valve. Therefore, rainwater cisterns are usually constructed as a combination structure to contain these volumes and fulfil both demands. The throttle valve is placed half way down the pipe, discharging rainwater with some delay into the sewer. In addition, there should be an emergency overflow in every cistern which is connected to the sewer.

Retention cisterns are designed to retain larger amounts of rainwater. The throttled discharge quantities of rainwater are adjustable from 0.1 - 1 l/s as standard. Retention cisterns are available in total capacities from 3,500 to 10,000 litres.

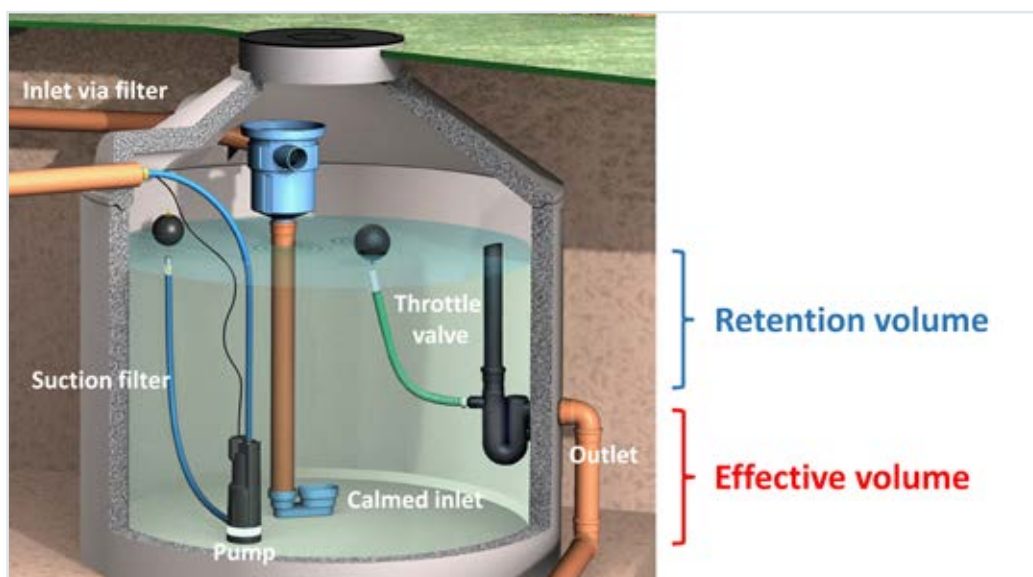

Figure 9: A retention cistern with a throttle valve (Source: Fa. Finger Stockstadt GmbH & Co. KG).



## Filters

Filters are effective in keeping rainwater clean and to prevent dirt and debris from entering the storage tank. There is a wide array of rainwater filters available on the market with different sizes and cleaning capacities (Figure 10). These filters can be placed in downpipes, before the cistern (pre-tank filters), in the cistern (in-tank filters), underground or above ground.

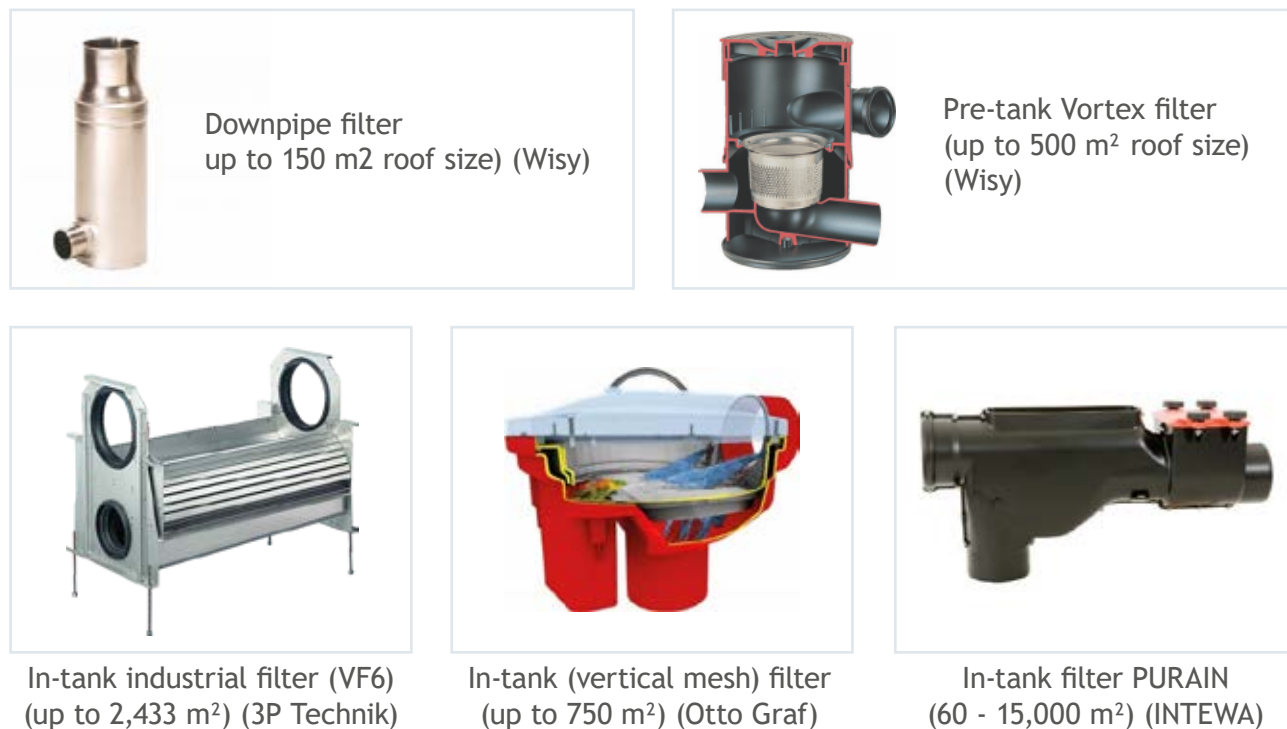

Figure 10: Different types of rainwater filters.

### 2.1.2. Sizing of a RWH system

The design and size of a RWH system is mainly determined by two factors: water supply and demand, both should approximately balance each other.

For the sizing of a RWH system:

- 1) Determine the amount of rainwater available for harvesting. This is an estimation of the amount of rainfall over a typical year that can be collected from a rooftop or other impermeable surfaces;
- 2) Estimate the water demand over the same period. If possible, determine the monthly/weekly or daily demand for each application over a full year;
- 3) Compare the amount of rainwater that can be harvested to the water demand over years and for dry seasons.

To determine the optimal storage tank size:

- If only rainwater utilisation is considered (e.g. for toilet flushing, irrigation, laundry), a rough guide value would be to provide 1000 litres of storage volume per 20 m<sup>2</sup> of runoff surface, or to dimension the storage tank such that 3 - 4 weeks of drought can be bridged;
- If rainwater harvesting is only seasonally operated or additional requirements for rainwater harvesting should be considered, special simulation programs should be used for the dimensioning of the storage tank.



Table 1: Factors influencing rainwater harvesting and storage design.

<b>Seasonal rainfall pattern &amp; annual distribution (mm)</b>	Depending on area/region
<b>Catchment area (m<sup>2</sup>)</b>	Roofs or other surfaces such as streets, courtyards, parking lots, etc.
<b>Daily non-potable water consumption (l/c/d)</b>	Depending on household size or number of persons and user habits
<b>Runoff coefficient</b>	Calculates the maximum amount of harvested rainfall and is dependent on the type of collection surface (metal roof, green roof, etc.)
<b>Storage capacity (m<sup>3</sup>)</b>	Depending on water demand and availability of space for storage

### 2.1.3. Operation and Maintenance

Regular cleaning of the catchment, collection and distribution systems is recommended to provide a properly functioning rainwater harvesting system.

Leaves and other debris should be removed frequently from roof gutters, downpipes and fine-mesh gutter covers to reduce debris and sediment deposits into the cistern (cleaning 2-3 times a year). Filters should be cleaned 1-2 times a year depending on the load from tree cover, pollen, dust, etc. A visual inspection of the tank is recommended once a year and excessive sediment should be removed as required. Pumps and pipework need to be checked for leaks and function once a year. The supply lines and taps must be adequately marked (non-potable water/recycled water) to prevent any accidental use of the harvested rainwater as drinking water source. A mains backup supply in a free inlet guarantees that no cross-connection to the drinking water network exists and ensures a continuous water supply when the cistern filling level drops.

### 2.1.4. Uses and applications for harvested rainwater

Largely unpolluted rainwater can be used for different purposes, which do not require a drinking water quality.

Outdoor use	Indoor use
✓ Gardening	✓ Toilet flushing
✓ Landscape irrigation	✓ Washing machines
✓ Farming	✓ Cleaning
✓ Cleaning	✓ Process water (industry)
✓ Car washing	
✓ Fire fighting	

For the use of harvested water as a drinking water source, rainwater should undergo the necessary treatment (see 2.1.9 Rainwater treatment for potable use in buildings).



### 2.1.5. Benefits

RWH systems offer a number of benefits at different levels (Table 2). Potential savings need to be assessed on an individual basis. Influencing factors include non-potable water demand, amount of collected rainwater and whether the property is charged by the volume of water used (metered water). Savings, both financial and environmental, are usually higher in commercial/industrial and public buildings, since these generally have larger roof areas and a higher non-potable water demand than private dwellings.

Table 2: Benefits of rainwater harvesting.

Individual level	Municipal level	Environmental level
Reduce dependency on mains water supply	Reduction in water consumption peaks	Conservation of groundwater resources
Reduced drinking water consumption	Relieve pressure on sewer	Reduced risk of flooding
Significant reduction in the drinking water costs	Lower municipal energy costs spent on pumping and water treatment	Reduced greenhouse gas emissions and air pollution (less energy for water pumping over long distances)
Availability of soft water for laundry and irrigation purposes	Delayed expenditures on new water treatment plants or existing plant expansions, resulting in financial and environmental savings	The use of rainwater for laundry is ecologically beneficial (20% savings in washing powder)

### 2.1.6. Performance

Performance of rainwater harvesting systems depends on the correct sizing of cistern and maintenance of system as a whole. The performance is measured both in terms of their capacity to conserve water as well as to reduce the volume of stormwater runoff leaving the site.

The cost effectiveness of a rainwater system is site-specific and the following factors should be taken into consideration:

- Current water charges: the higher the cost of water, the higher are the benefits
- Maintenance costs: the level of maintenance required by the system during its lifetime.

### 2.1.7. Costs

The rainwater tank is often the most expensive part of a RWH system, which usually account for about 30% of the whole life costs. Therefore, choosing the right size is a key to reducing costs. The tank size must be a balance between cost and storage capacity.

Installing a system during new construction generally costs less than retrofitting a system into an existing building, mainly due to excavation works to install the tank and changes required in the existing plumbing network.



The total construction costs for a one-family house lie approx. between 2,500 to 5,000 € depending on the amount of work involved as well as the size of storage tank and product quality<sup>12</sup>. Maintenance costs amount to approx. 100 € per year.

### 2.1.8. Hygienic aspects

Rainwater from roof surfaces may be contaminated with faeces of birds or small mammals, which may contain pathogens<sup>13</sup>. However, light and dry conditions on the roof and the first flush diversion or final filtration will significantly reduce the bacterial concentration in runoff. Also, underground cisterns have low temperatures, which do not enhance bacterial growth. Due to these effects, in addition to a proper operation and maintenance, cistern water generally fulfills the requirements of the EU Directive for Bathing Water<sup>14</sup> and as such can be safely used for non-potable applications in households and industry.

### 2.1.9. Rainwater treatment for potable use in buildings

Depending on the quality of the rainwater entering the cistern, rainwater can be treated for potable use applying different methods. Available technologies, which are also traditionally used to treat drinking water include:

- Slow sand filters to reduce suspended particles, bacteria and dissolved organic compounds found in rainwater with or without downstream disinfection (UV light, ozone or chlorine)
- Activated carbon filters to reduce particles, bacteria and dissolved organic components found in rainwater with or without downstream disinfection (UV light, ozone or chlorine)
- Membrane filtration such as microfiltration, ultrafiltration, nanofiltration and reverse osmosis. However, these are more costly than other filtration methods.

Disinfection with UV light is preferred over chlorination or ozonation, as it does not produce disinfection by-products such as trihalomethanes (THMs), which have adverse effects on human health. In addition, UV disinfection offers several advantages:

- It can handle large flow rates
- UV treated water can be used immediately after treatment
- Rainwater treated with UV is less of a corrosion risk to exposed metal.

One disadvantage of UV disinfection is that it requires that rainwater be free from suspended solids for the disinfection process to be effective.

Filtration of the rainwater with carbon filters improves taste and odour and also discolouration to a certain extent. Carbon is also effective at removing chlorine and other volatile organic compounds (VOCs).

<sup>12</sup> <https://www.umweltbundesamt.de/umwelttipps-fuer-den-alltag/garten-freizeit/regenwassernutzung#gewusst-wie>

<sup>13</sup> Campisano, A., Butler, D., Ward, S., Burns, M.J., Friedler, E., DeBusk, K., Fisher-Jeffes, L.N., Ghisi, E., Rahman, A., Furumai, H. and Han, M., 2017. Urban rainwater harvesting systems: Research, implementation and future perspectives. *Water research*, 115, pp.195-209

<sup>14</sup> EU Directive for Bathing Water (2006). Directive 2006/7/EC of the European Parliament and of the Council of 15 February 2006 concerning the management of bathing water quality and repealing Directive 76/160/EEC. Jo L 64, 4.3.2006



### 2.1.10. Normative standards

The European Standard EN 16941-1:2018 had been published in 2018 by the European Committee for Standardisation (CEN)<sup>15</sup>. It specifies the requirements and gives recommendations on the design, sizing, installation, and maintenance of rainwater harvesting systems for onsite use of rainwater as non-potable water source. This European Standard also specifies the minimum requirements for these systems.

### 2.1.11. Rainwater harvesting for adiabatic cooling in buildings

Harvested rainwater can be used for indirect evaporation cooling via “adiabatic cooling” (adiabatic exhaust air cooling), which can be applied for indoor air conditioning. This is based on the principle of “cold recovery” via evaporation processes, in which the temperature of the supplied (inlet) air is lowered by means of a heat exchanger. The air which is removed from the room as exhaust air is moistened and cooled as a result. The cooled air is then transported into a combined circulation system or a plate heat exchanger to the outside warmer air (Figure 11). For every cubic metre of water, about 700 kWh cooling capacity can be released<sup>16</sup>.

For technical reasons, the electrical conductivity of the water used for adiabatic cooling should not exceed 1600  $\mu\text{S}/\text{cm}$ . Since rainwater has a low conductivity (approx. 50  $\mu\text{S}/\text{cm}$ ), it is very well suited for adiabatic cooling<sup>17</sup>. By using rainwater for cooling buildings, drinking water and energy can be saved.

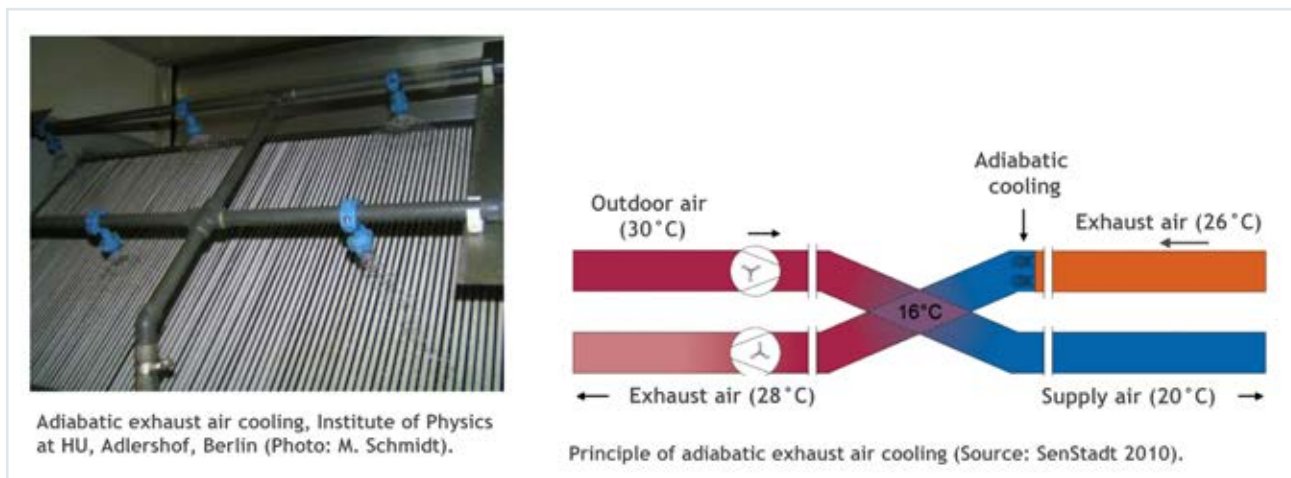

Figure 11: Principle of adiabatic cooling in buildings using rainwater.

15 EN 16941-1:2018 (2018) On-site non-potable water systems - Part 1: Systems for the use of rainwater. The European Committee for Standardisation (CEN)

16 Berlin (2010) Rainwater Management Concepts - Green buildings, cooling buildings. Planning, construction, operation and maintenance guidelines. Senate Department for Urban Development and Housing. [https://www.stadtentwicklung.berlin.de/bauen/oekologisches\\_bauen/de/download/index.shtml](https://www.stadtentwicklung.berlin.de/bauen/oekologisches_bauen/de/download/index.shtml)

17 fbr (2013) Energetische Nutzung von Regenwasser. Schriftenreihe der Band 136. Fachvereinigung Betriebs- und Regenwassernutzung e.V.





## 2.2. Rainwater retention and evapotranspiration

Rainwater retention in urban areas have several benefits such as increasing evapotranspiration, reducing runoff rates and volumes and providing water storage for different purposes such as irrigation, greening or adiabatic cooling. In comparison, infiltration systems, such as swales and swale-trench systems effect low evapotranspiration (10%). Some examples of rainwater retention measures include green roofs and facades, retention ponds, rain gardens, wetlands, etc.

### 2.2.1. Green roofs

Green roofs are lightweight, vegetated roof systems which mainly consist of a waterproof protective membrane, a growing medium (substrate), selected plants and a drainage layer (Figure 12). They can be installed on most roofs of buildings (mostly on flat roofs) and are used to prevent or delay the runoff through targeted retention and to increase evaporation. A distinction is made between extensive and intensive green roofs depending on the plant material and the planned use of the roof area (Table 3).

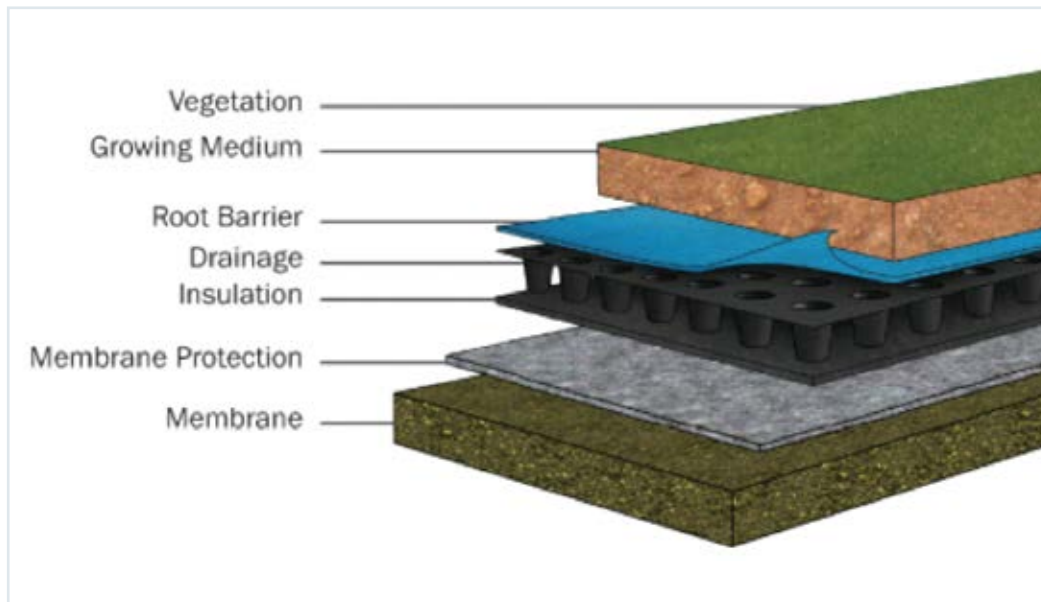

Figure 12: Schematic diagram of a multilayer system of a green roof<sup>18</sup>.



Table 3: Comparison between extensive and intensive green roofs.

	Extensive green roof	Intensive green roof
Costs	Low	High
Irrigation	None	Regular
Maintenance	Low	High
Vegetation	Drought-tolerant succulents and grasses	Lawn or perennials, shrubs and trees
Soil layer depth	8 - 15 cm	15 - 100 cm
Bearing load (water saturated)	90 - 180 kg/m <sup>2</sup>	> 180 kg/m <sup>2</sup>
Uses	Ecological protection layer	Park-like garden

In summer, green roofs can retain 70 - 80% of rainfall and in winter between 25 and 40% depending on the growing medium, its depth and the type of plants used. Green roofs initially reduce peak flows and improve the water quality. They possess high retention and evaporation capacities, thus reducing the heat island effect in urban areas. Green roofs also improve insulation and increase the lifespan of a roof.

When constructing green roofs, damage of the membrane by root growth should be considered. This can be determined using the FLL procedure<sup>19</sup> for investigating resistance to root penetration at green roof sites.

Green roofs are easiest to design for new construction but may also be retrofitted. Green roof plantings require care and watering until they are established, generally the first 1 to 2 years after installation.



Figure 13: Intensive - perennials, grasses, shrubs - Sport facilities La Tesorina, Torino (Photo: A. Aires).

<sup>19</sup> FLL Green Roof Guidelines (2018). Guidelines for the planning, construction and maintenance of green roofs <https://shop.fll.de/de/english-publications/green-roof-guidelines-2018-download.html>



Figure 14: Extensive green roof - sedum, sempervivum - Paguro Children playhouse, Torino (Photo: A. Aires).



Figure 15: Intensive green roofs (Optigrün).

## 2.2.2. Green walls/facades

A green wall is defined as a system in which plants grow on a vertical surface such as a building facade under regular maintenance. Climbing plants grow naturally on building facades by attaching themselves to surface by means of various mechanisms. The main elements of green walls are: plants, a growing medium (substrate), structures that support and attach plants to the facade and an irrigation system (rainwater as a water source). Green walls are broadly grouped into two categories: system-bound and ground-bound green walls.

A system-bound green wall is a green wall system, where the planting medium is not integral to the facade. The planting medium is usually carried in horizontal planters, which may be located on the ground or at multiple intervals along the height of the façade (Figure 16). Climbing plants are



## Thematic Catalogue 2 - PART 1

supported by horizontal, vertical, or diagonal grids attached to the building façade. Ground-bound vegetation use climbing plants such as Virginia Creeper, Ivy, or climbing Hortensia which are planted in the ground.

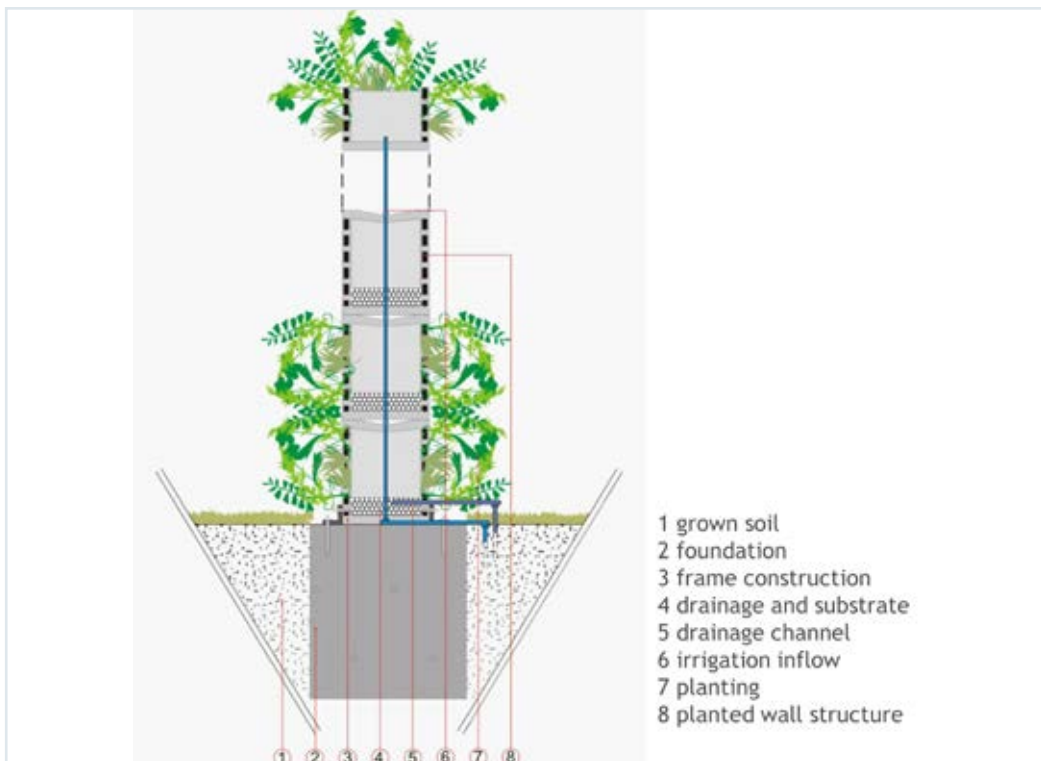

Figure 16: Side view of a system-bound green facade<sup>20</sup>.



Figure 17: Ground-bound green wall with Virginia creeper (left, Photo: D. Kaiser) and system-bound green wall at the Institute of Physics in Berlin-Adlershof (Photo: M. Schmidt).

<sup>20</sup> Köhler (2012) (Hsg.) Handbuch Bauwerksbegrünung - Planung, Konstruktion, Ausführung. Verlagsgesellschaft Rudolf Müller, Köln



Ground-bound green walls are usually irrigated directly at and into the root zone from infiltrating runoffs. System-bound facade greening requires appropriate irrigation systems including fertilisation. Irrigation should follow automatically, especially in case of larger plantings and planter boxes. When using cistern water, it is important to ensure that no surface runoff with possible herbicide load is connected, which can lead to vegetation collapse.

Table 4: Suitable plants for green walls<sup>21</sup>.

<b>Self-bonders with a growing height up to 30 m</b>	Common ivy ( <i>Hedera helix</i> ) Three leaved creeper ( <i>Parthenocissus</i> )
<b>Self-bonders with a growing height from 8 - 25 m</b>	American trumpet creeper Old man's beard ( <i>Clematis vitalba</i> ) Staff vine ( <i>Celastrus orbiculatus</i> ) Russian vine ( <i>Fallopia baldschuanica</i> ) Chinese Wisteria ( <i>Wisteria sinensis</i> )
<b>Self-bonders and climbers with a climbing construction and growing height from 5 - 15 m</b>	Kiwi ( <i>Actinidia chinensis</i> ) Birthworts ( <i>Aristolochia</i> ) Wild hop ( <i>Clematis virginiana</i> ) Honeysuckle ( <i>Lonicera</i> ) Five leaved creeper ( <i>Parthenocissus</i> family) Japanese wisteria ( <i>Wisteria floribunda</i> )
<b>Small climbers with a growing height up to 5 m</b>	Old man's beard hybrides ( <i>Clematis vitalba</i> ) Japanese spindle ( <i>Euonymus</i> ) Black Bryony ( <i>Dioscorea communis</i> ) Climbing rose
<b>Small climbing plants</b>	Red bryony ( <i>Bryonia dioica</i> ) Field Bindweed ( <i>Convolvulus arvensis</i> ) Larger Bindweed ( <i>Convolvulus sepium</i> ) Bittersweet ( <i>Solanum dulcamara</i> ) Sweet pea ( <i>Lathyrus odoratus</i> )

### 2.2.3. Rain gardens (Bioretention systems)

Bioretention systems, also referred to as rain gardens, are landscaped features designed to collect runoff from impervious surfaces such as roofs, walkways and parking lots and infiltrate it into the underground. The soil (engineered or mixed soil) consists of a mixture of sand, topsoil and composted mulch. Rain gardens are planted with trees, shrubs, and perennials before being covered in a layer of organic mulch, which intercepts silt and pollutants. They usually require a drainage layer with a perforated pipe and an overflow, which conveys relatively clean water to the next stage of the management train or to the stormwater sewer.

Rain gardens can take any shape, but they are generally constructed as trapezoidal structures. The flat bottom area (base area) is used as the measure of the rain garden's size. The area required for side slopes is added to the base area and this total area is considered for fitting a rain garden into a site. The bottom of the rain garden must be planted in order to function properly.

<sup>21</sup> Hermy M., Schauvliege M. & Tijskens G. (2005) Groenbeheer - een verhaal met toekomst; Velt i.s.m. afdeling Bos & Groen, Berchem

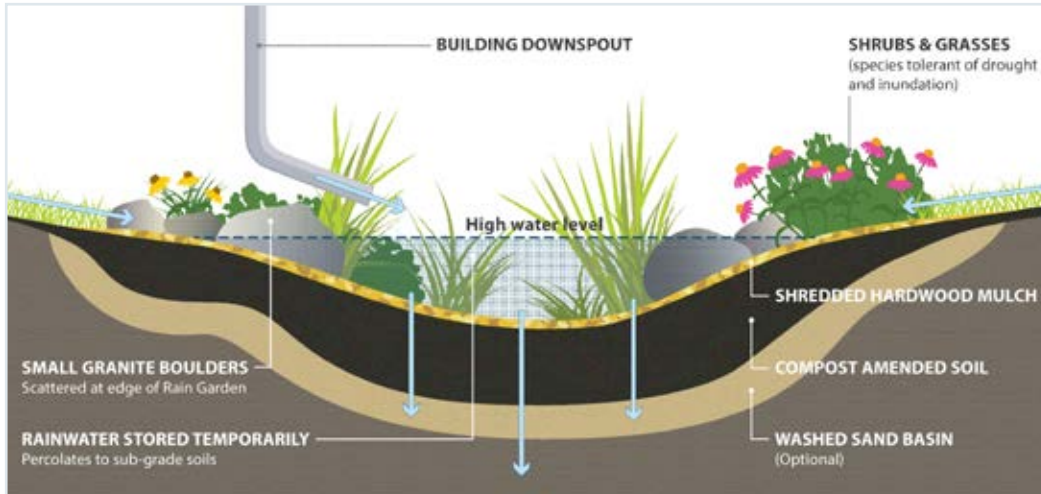

Figure 18: Cross-section in a raingarden<sup>22</sup>.

Rain gardens may also have a rock reservoir which provide an additional volume capture and infiltration capacity. The reservoir can be constructed with growing medium, sand or rock. In this case, the reservoir is wrapped with a geotextile membrane to prevent the surrounding soil or above growing medium from entering the rock reservoir causing a decrease in the water-holding capacity.

A rain garden requires watering in the first 2 years until plants get established. It should not need watering after the first 2 years. The first year of maintenance can be challenging as plants become established.



Figure 19: Examples of urban rain gardens<sup>23</sup>.

22 Toronto and Region Conservation Authority. <https://trca.ca/news/complete-guide-building-maintaining-rain-garden/>  
23 <https://www.c-ville.com/rain-gardens-lovely-way-protect-planet/>



## 2.2.4. Retention ponds

Retention ponds are wet ponds designed to permanently retain a certain volume of water and provide temporary storage of the runoff. They collect rainwater during heavy rains and throttle it slowly into the sewer or used for other purposes such as for groundwater recharge or irrigation. Retention ponds differ from constructed wetlands by having a greater average depth of water, thus allowing for large variations in the water level during storms. Vegetation is an integral part of a retention pond, which contributes to pollutant removal, erosion prevention and creates habitat.

Retention ponds improve the quality of water through natural processes such as sedimentation, biodegradation, solar disinfection and soil filtration. As a natural system, they require no energy or high-tech appliances. Soils below the pond should be sufficiently impermeable to stop the water from drying out. A geotextile liner or impermeable material will be required if underlying soils are permeable.

Retention ponds are designed to support emergent and submerged aquatic vegetation and can be effectively incorporated into parks through good landscape design.

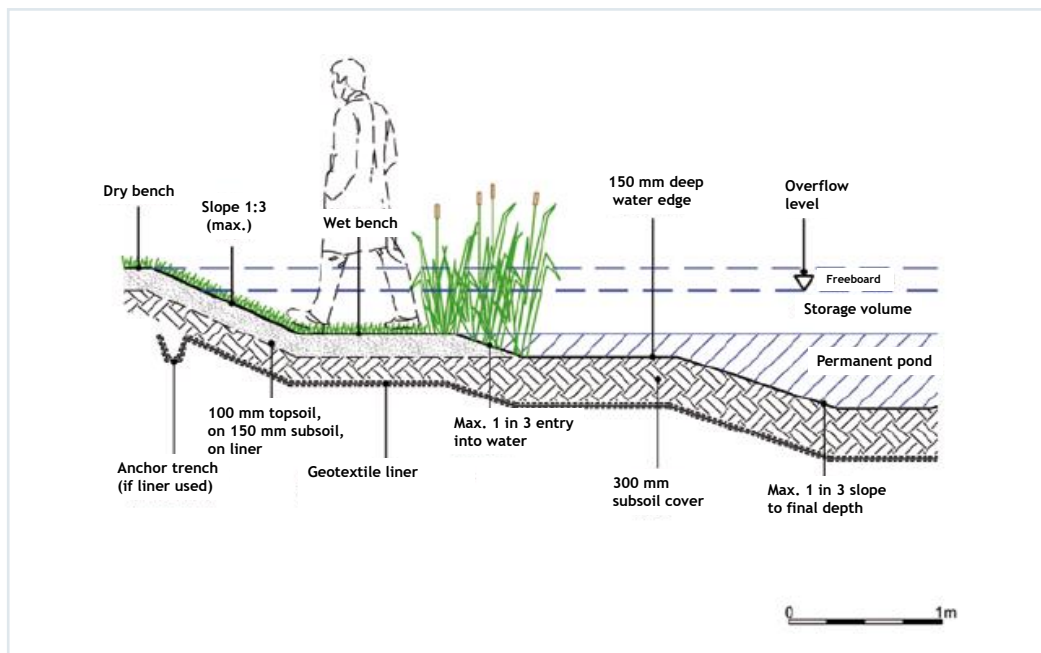

Figure 20: Edge profile of a retention pond<sup>24</sup>.

<sup>24</sup> Anglian Water. Towards sustainable water stewardship. Sustainable drainage systems (SUDS) adoption manual. Anglian Water Services limited. [https://www.anglianwater.co.uk/siteassets/developers/aw\\_suds\\_manual\\_aw\\_fp\\_web.pdf](https://www.anglianwater.co.uk/siteassets/developers/aw_suds_manual_aw_fp_web.pdf)



Figure 21: Examples of retention ponds<sup>25</sup>.

### 2.2.5. Free surface flow constructed wetlands

Manuals of sustainable drainage systems usually refer to wetlands, referring to what in the constructed wetland (CW) literature are known as Free Water Surface wetlands (FWS).

FWS are marshy systems for treatment of rainwater that permanently retain a certain volume of water. Are more vegetated in comparison to ponds, since FWS are usually designed with a high variety of water depths within the bed, including deeper pools that facilitate sedimentation and shallower areas that allow for plant growth and better dissolved pollutant removal<sup>26</sup>.

FWS provide temporary storage of runoff above the permanent pool and reduce the runoff peak. The runoff volume from each rainfall event is treated and discharged through a throttled outflow. FWS require a pre-treatment system or a sediment forebay to avoid the risk of rapid silt accumulation.

The plants growing in the FWS reduce flow velocities, making this wetland type very efficient in removing suspended solids and associated pollutants. FWS can be planted with emergent and submergent vegetation, native plants being usually preferred, as they are less expensive and more resistant.

The dimensioning main challenge is represented by the stochastic nature of the rainfall events. The design of FWS includes:

- A sedimentation basin as forebay, as a pre-treatment system to allow for sedimentation of suspended solids to avoid potential damage and facilitate maintenance
- A combination of marshes and deeper pools, the shallower areas support development of vegetation and allow sufficient oxygen exchange, the deeper pools permit sedimentation and decrease the risk of sediment re-entrainment near the outlet
- An aquatic bench that acts as a biological filter and provides safety and amenity benefits
- Additional features include the inlet, an outlet with a flow-control system, an emergency spillway, a safety bench and a maintenance access.

<sup>25</sup> Woods Ballard, B., Wilson, S., Udale-Clarke, H., Illman, S., Scott T., Ashley, R. and Kellagher. 2015. The SuDS Manual. Department for Environment Food and Rural Affairs. CIRIA 2015. <https://www.susdrain.org/>

<sup>26</sup> Kadlec R.H., Wallace S.D. (2009), "Treatment wetlands - Second Edition", Lewis, Boca Raton





## Thematic Catalogue 2 - PART 1

Since wetland systems are constructed using local labour and materials, costs are variable depending on the location and the distance from the production site. Capital costs are comparable to alternative technologies which include earthwork, liners (if needed) and plants. Operative costs can be quite low: energy costs are generally low for FWS and maintenance costs become significant, if a specific vegetation is maintained.

The implementation of a wetland involves the creation of a new habitat, which leads to an increase in biodiversity and amenity and an added recreational value in comparison to simple ponds.

FWS can be combined with a subsurface flow CWs (Section 2.2.6) to increase treatment performance, storage capacity, biodiversity and recreational value.

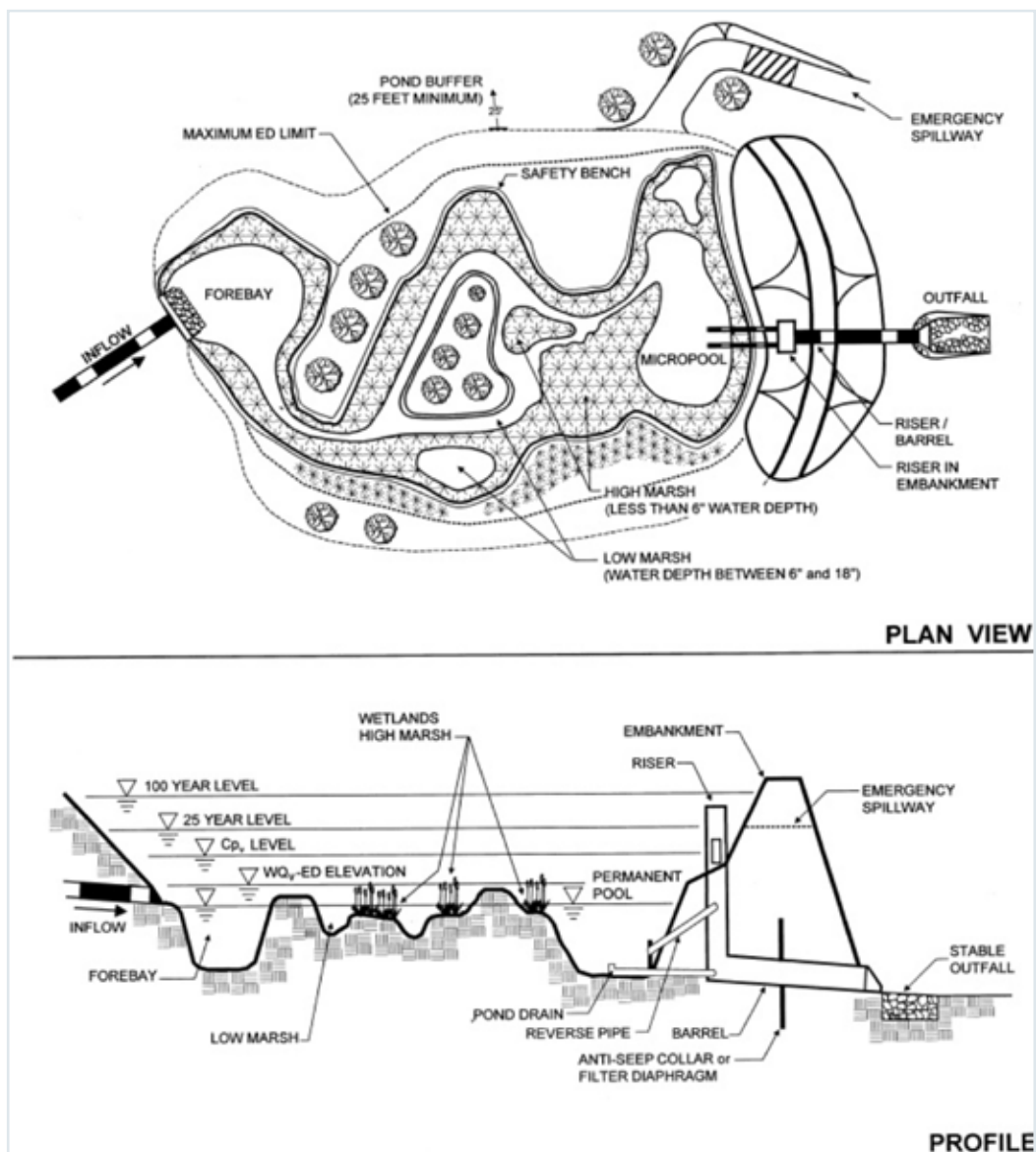

Figure 22: Schemes of FWS for stormwater treatment<sup>27</sup>.

27 Haubner, S.M. (2001) Georgia Stormwater Management Manual



Figure 23: Examples of FWS for stormwater treatment (Source: IRIDRA Srl)<sup>28</sup>.

### 2.2.6. Subsurface flow constructed wetland

Subsurface flow constructed wetlands are wetland systems in which the stormwater flows through a porous media of selected size (typically sand or gravel).

A well-known application of subsurface flow wetland for stormwater treatment is the so-called retention soil filters (RSF). They are a specific form of vertical flow constructed wetlands for the treatment of rainwater. The name stems from the late 1980s, when the first systems were built with soil as filter material. Due to problems with clogging, the filter material is nowadays usually sand (0/2 mm), with a steep sieve curve. Cohesive soil is no longer allowed for new systems. The German approach remains distinguished as RSF (“Retention Soil Filter”), although it would be more logical to refer to it as “Retention Sand Filter”<sup>29</sup>.

Retention soil filters are usually designed in two stages, a pre-stage (sedimentation tank) and a vertical-flow retention soil filter planted with reeds. The RSF is sealed against the ground and operated in a throttled mode. Water is conveyed to the drainage system via an outlet.

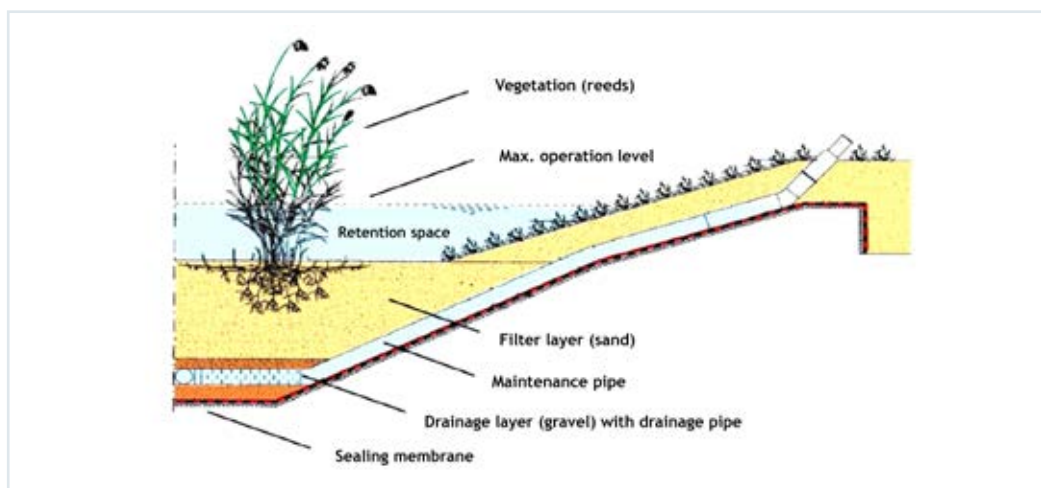

Figure 24: Edge profile of a conventional retention soil filter (RSF).

<sup>28</sup> [www.igidra.com](http://www.igidra.com)

<sup>29</sup> Meyer, D., Molle, P., Esser, D., Troesch, S., Masi, F. and Dittmer, U. (2013) Constructed wetlands for combined sewer overflow treatment—Comparison of German, French and Italian approaches. *Water* 5(1): 1-12



Figure 25: Retention soil filters in Berlin (Photo: Andreas Süß).

Retention soil filters are usually dimensioned iteratively using long-term simulations. The sediment load of the filter should not exceed 7 kg filterable substances/m<sup>2</sup>. In addition, an average feeding frequency of  $\geq 10$  per year and an annual impoundment time  $\leq 48$  h must be observed<sup>30</sup>.

Retention soil filters, and subsurface flow wetland in general, provide very good retention of particulate and partly dissolved substances (93%). For phosphorous, the removal efficiency is approx. 80%. Significant removal efficiencies have been reported also for pathogen, metals, and emerging contaminants<sup>31</sup>. In addition to the high cleaning capacity, retention soil filters significantly attenuate peak discharges, due to the throttled discharge, reducing the hydraulic load on the water body. Due to the sealed design, there is no interaction with the groundwater.

Subsurface flow wetlands, including RSFs, can be also successfully applied for the treatment of combined sewer overflow, in which stormwater is mixed with sewage<sup>32</sup>.

### 2.2.7. Detention basins

Detention Basins are dry basins which attenuate stormwater runoff by providing temporary storage with flow control of the attenuated runoff. Where vegetated, they also provide treatment of the rainwater in terms of solid removal and sedimentation. Detention basins are usually found at the end of a SUDS management train. They are normally dry and therefore, under certain conditions they can also function as a recreational facility.

30 MUNLV 2015. Retentionsbodenfilter. Handbuch für Planung, Bau und Betrieb. Ministerium für Klimaschutz, Umwelt, Landwirtschaft, Natur- und Verbraucherschutz (MUNLV) des Landes Nordrhein-Westfalen. 2 Auflage. [https://www.umwelt.nrw.de/fileadmin/redaktion/Broschueren/retentionbodenfilter\\_handbuch.pdf](https://www.umwelt.nrw.de/fileadmin/redaktion/Broschueren/retentionbodenfilter_handbuch.pdf)

31 Tondera, K., Blecken, G. T., Chazarenc, F. and Tanner, C.C. (Editors) (2018) Ecotechnologies for the Treatment of Variable Stormwater and Wastewater Flows. Springer Briefs in Water Science and Technology

32 Rizzo, A., Tondera, K., Pálffy, T.G., Dittmer, U., Meyer, D., Schreiber, C., Zacharias, N., Ruppelt, J.P., Esser, D., Molle, P., Troesch, S., Masi F. 2020. Constructed wetlands for combined sewer overflow treatment: A state-of-the-art review. Science of The Total Environment 727: 138618



## Thematic Catalogue 2 - PART 1

A detention basin remains dry until a storm occurs, in contrast to a retention pond which holds water also during dry weather conditions and is designed to hold more water when it rains. The key concern is not their performance under extreme conditions but their long-term viability and the level of maintenance that is needed to keep them operating efficiently.

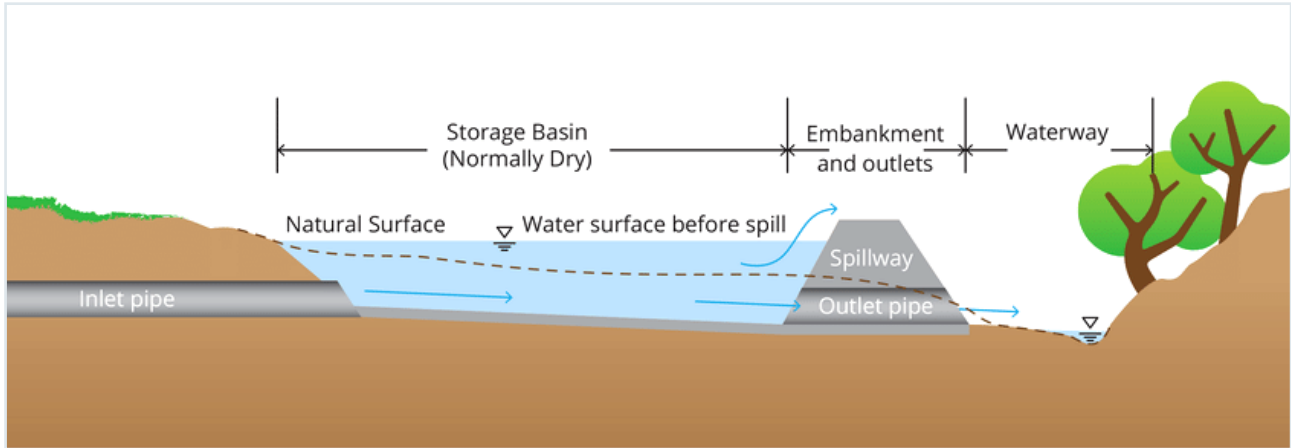

Figure 26: A typical section of a detention basin<sup>33</sup>.



Figure 27: Detention basins during dry and wet periods<sup>34</sup>.

33 Coombes, P., and Roso, S. (Editors) (2019) Runoff in Urban Areas, Book 9 in Australian Rainfall and Runoff - A Guide to Flood Estimation, Commonwealth of Australia, Commonwealth of Australia (Geoscience Australia)

34 A guide to support the selection, design and implementation of Natural Water Retention Measures in Europe (NWRM): Capturing the multiple benefits of nature-based solutions (2014). European Commission, Directorate-General for Environment. [www.nwrmeu](http://www.nwrmeu)



## 2.3. Infiltration

Infiltration allows rainwater to percolate slowly through the topsoil layer (with or without vegetation) into the underground reducing pollutant load and contributing to groundwater recharge. Infiltration is mostly suited for low polluted runoffs. A fall-off in infiltration rates with time as a result of clogging of soil should be considered during the planning process.

Surface infiltration through permeable pavings, swales or trenches have been successfully used for decades for onsite rainwater management. Recently, combined systems such as the “swale-trench” system have been commonly used to reduce runoff in poorly permeable soils.

During infiltration through the subsoil, rainwater is treated via several biotic and non-biotic processes including adsorption, sedimentation, biodegradation and filtration. The infiltration zone should have at least 30 cm of active topsoil for optimal filtering effect of the contaminants found in rainwater.

A prerequisite for any rainwater infiltration system is the permeability of the soil including its biologically active, humus-rich topsoil layer. The permeability of the soil is expressed by its permeability coefficient,  $k^f$ , which is determined by simple permeability tests. Significant infiltration can be achieved in soils with  $k^f$  between  $1 \times 10^{-3}$  m/s and  $1 \times 10^{-6}$  m/s.

The following requirements should be met for any infiltration measure taken:

- The hydrogeological conditions of the soil and subsoil must be confirmed for suitability and stability by geotechnical tests and consideration must be given to the need to protect the underlying groundwater from possible contamination
- A good permeability of the soil for infiltration
- The groundwater table should be more than 1 m below the base of the infiltration structure
- Infiltration systems should not be constructed within 5 m of the foundations of buildings
- Only low polluted rainwater should be infiltrated or pre-treated runoffs
- Soil compaction at infiltration site should be avoided.

In general, the selected infiltration measure will depend on soil permeability and properties, available area, sensitivity of the aquifer and the degree of rainwater pollution.

Figure 28 shows potential application areas for different infiltration systems as a function of soil permeability and availability of space.

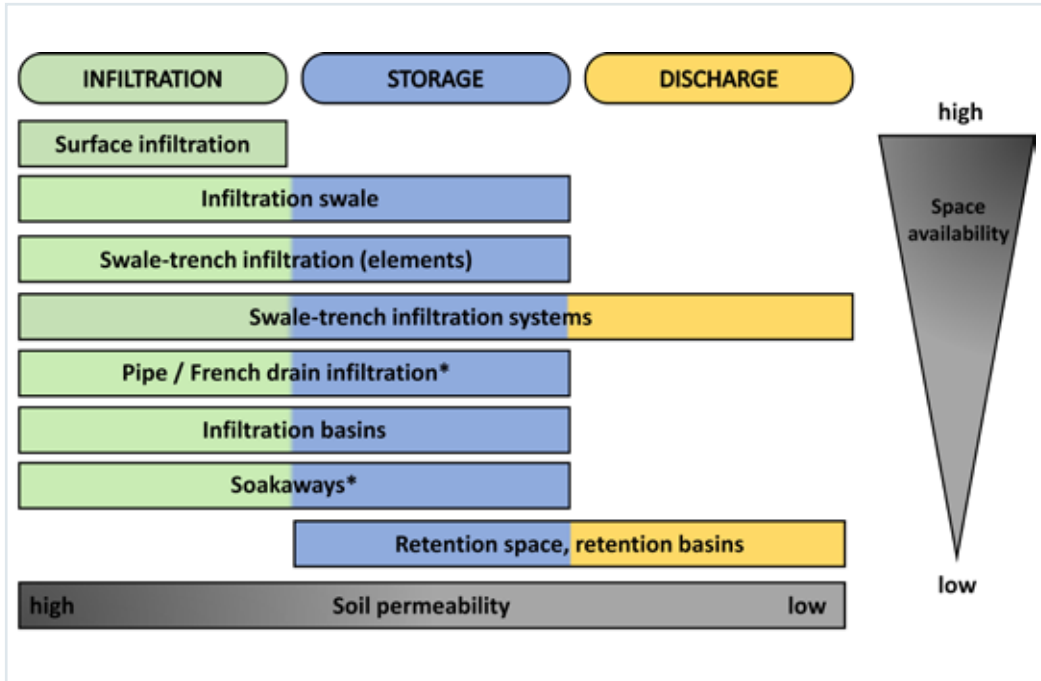

Figure 28: Application areas for different infiltration systems depending on soil permeability and availability of space<sup>35</sup> (\* Not recommended).

Table 5 shows the selection criteria for the applicability of swale and swale-trench systems for rainwater infiltration depending on soil permeability ( $k_f$ ) and availability of space.

Table 5: Selection criteria for some infiltration technologies under different soil and area conditions (Adapted from Londong & Nothnagel, 1999).

Permeability				Selection procedure for rainwater infiltration measures	
Class	Permeability	$k_f$ from	$k_f$ to	Low area availability <sup>(1)</sup>	High area availability <sup>(2)</sup>
II	high	$1 \cdot 10^{-5}$	$5 \cdot 10^{-6}$	 Swale infiltration	 Swale infiltration 10 : 1
II	medium	$5 \cdot 10^{-6}$	$2 \cdot 10^{-6}$	 Swale-trench infiltration without discharge	 Swale infiltration 6 : 1
III	moderate	$2 \cdot 10^{-6}$	$7 \cdot 10^{-7}$	 Swale-trench infiltration with partial throttled discharge	 Swale infiltration 4 : 1
IV	low	$7 \cdot 10^{-7}$	$2 \cdot 10^{-7}$	 Swale-trench infiltration with throttled discharge <sup>(3)</sup>	 Swale infiltration 2 : 1

(1) Ratio of connected sealed area to infiltration area is 10:1; (2) Ratio of connected sealed area to infiltration area as indicated; (3)  $k_f$  value without limitation downwards.

35 Londong, D. Nothnagel, A. (1999) Bauen mit dem Regenwasser. Aus der Praxis von Projekten. Oldenbourg Industrierlag München



### 2.3.1. Permeable / porous paving

Permeable or porous pavings allow rainwater to infiltrate into the ground over several layers of different fine-grained materials. Depending on ground conditions, water may infiltrate directly into the subsoil or stored in an underground reservoir (e.g. a crushed stone layer), before slowly soaking into the ground. If infiltration is not possible, an impermeable membrane can be used with an overflow to keep the pavement water-free. The most commonly used permeable pavings are permeable concrete, porous asphalt, paving stones, grass-concrete blocks and permeable interlocking concrete pavers (PICP).

All permeable pavings have a similar design layering system, consisting of a surface pavement layer, an underlying stone aggregate reservoir layer, underdrains for filtration and a geotextile over non-compacted soil subgrade (Figure 29). Rainwater percolates and infiltrates through the pavings into the aggregate layers and/or soil below. Depending on the ground conditions, water may infiltrate directly into the subsoil or stored (retained) in the underground reservoir, before slowly soaking into the ground. If infiltration is not possible, an impermeable membrane can be used with an overflow which is piped away. In this case, permeable pavings act only as retention measures.

Application areas include street surfaces for light traffic, parking lots, courtyards, pedestrian areas, residential sidewalks, sports facilities, etc.

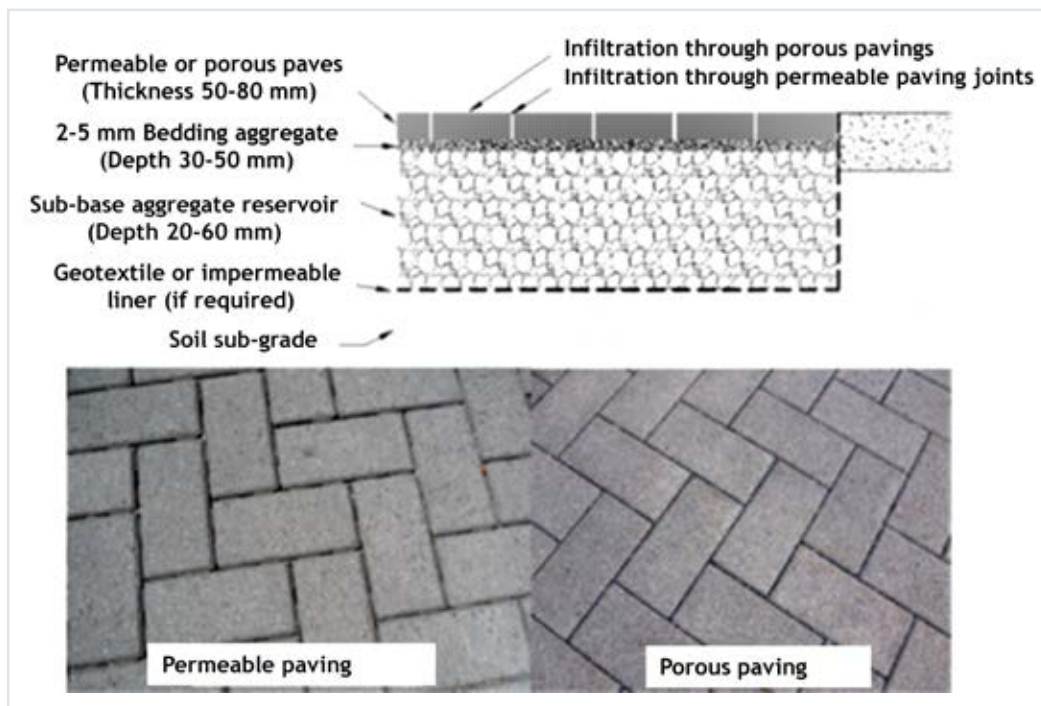

Figure 29: Design structure of a typical permeable paving.



## Thematic Catalogue 2 - PART 1



Gravel lawn: a mixture of humus and gravel/grit. Lawn seeds are scattered on surface and compacted



Gravel/grit paving: gravel or grit with uniform medium grain size, placed on a permeable foundation



Grass paver: concrete blocks with honeycomb openings filled with humus and overgrown with lawn; green space over 40%



Porous asphalt: paving stones with large-pored grain structure. In combination with water-permeable joints the paved areas are largely drainless



Concrete paving: paving stones with spacers which ensure for wide gaps (joints) between the paving stones, overgrown with grass and plants; gaps up to 35%



Grit paver: made of paving stones with narrow gaps which are filled with grit or gravel

Figure 30: Different types of permeable and porous pavings.



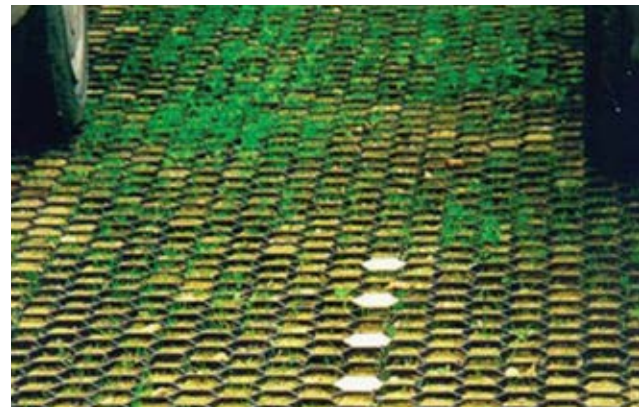

Table 6: Runoff coefficients for different surfaces.

Type of paving	Runoff coefficient
Simple grass cover (turf) Intensive green roof	0 - 0.2
Gravel lawn	0.2 - 0.3
Extensive green roof	0.3 - 0.5
Grass pavers	0.4 - 0.5
Mosaic or small pavers with large joints	0.5 - 0.6
Medium and large pavings with open joints	0.5 - 0.7
Interlocking paving and slabs	0.5 - 0.8
Concrete and asphalt paving	0.9
Metal and glass roofs	0.95



Concrete paving



Interlocking grass pavers with initial greening



Grass pavers on bike parking space



Paving with open joints (gaps) and grass pavings for car parking

Figure 31: Different applications for permeable pavings (pedestrian, vehicles and bike paths).



### 2.3.2. Filter strips

Filter strips are broad, gently sloping areas of grass or other densely vegetated strips of land that collect surface water runoff from impermeable surfaces. The runoff flows as a sheet across the filter strip which slows the flow of water and intercepts silt and pollution allowing some water to infiltrate into the ground. Filter strips are usually used to protect other infiltration structures further down the management train. Because they use sheet flow and not channelised flow they are more effective than swales at removing suspended solids from runoff.

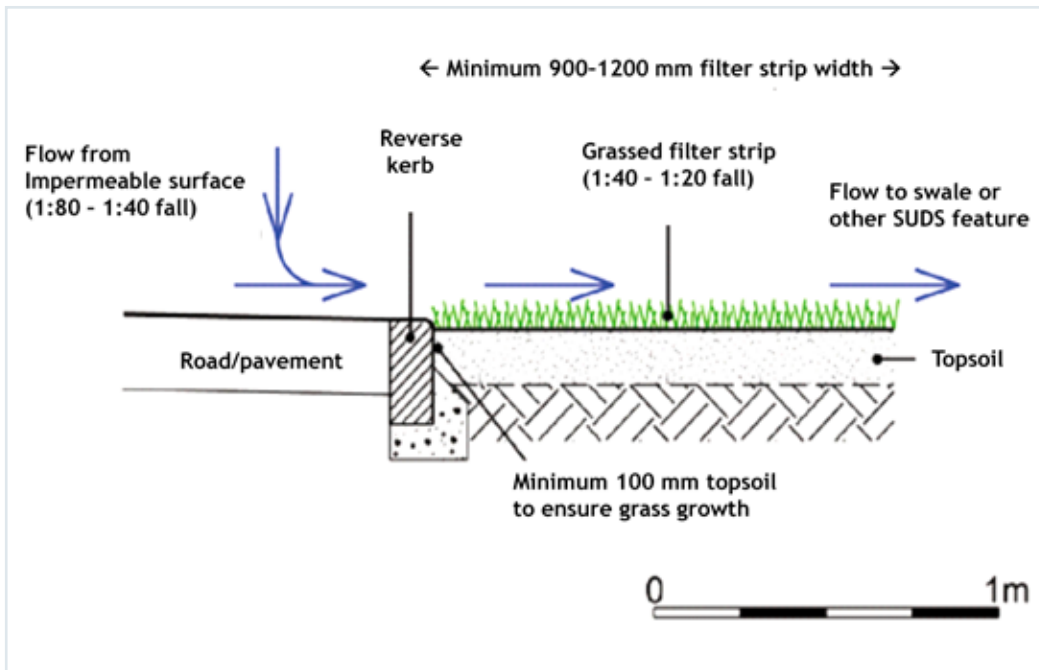

Figure 32: A schematic diagram of a filter strip (Anglian Water).



Figure 33: A filter strip adjacent to a road<sup>36</sup> and in the centre of town (NWRM).

36 <https://www.susdrain.org/delivering-suds/using-suds/suds-components/filtration/filter-strips.html>



Filter strips are designed to treat sheet flow with minimum residence time of 5 minutes. The flow velocities need to be kept low to enhance pollutant removal. In the UK, a maximum flow velocity of 0.3 m/s is recommended to promote sedimentation. Filter strips are ideally 5 - 15 m long to be effective and minimum 90 - 120 cm wide. Grass or vegetation should be able to withstand wet and dry conditions as well as high flow velocities. Channelisation and early system failure may result from poor design and construction or lack of maintenance.

### 2.3.3. Swales (vegetated swales / bioswales)

Swales are open, wide and shallow channels usually covered by grass and which convey rainwater from sealed surfaces, treat, filter and infiltrate it into the ground. The vegetation helps trap pollutants and reduce the velocity of the stormwater runoff. Swales are usually used when the area for surface infiltration is not sufficient. They serve as a temporary storage, treatment and an infiltration measure.

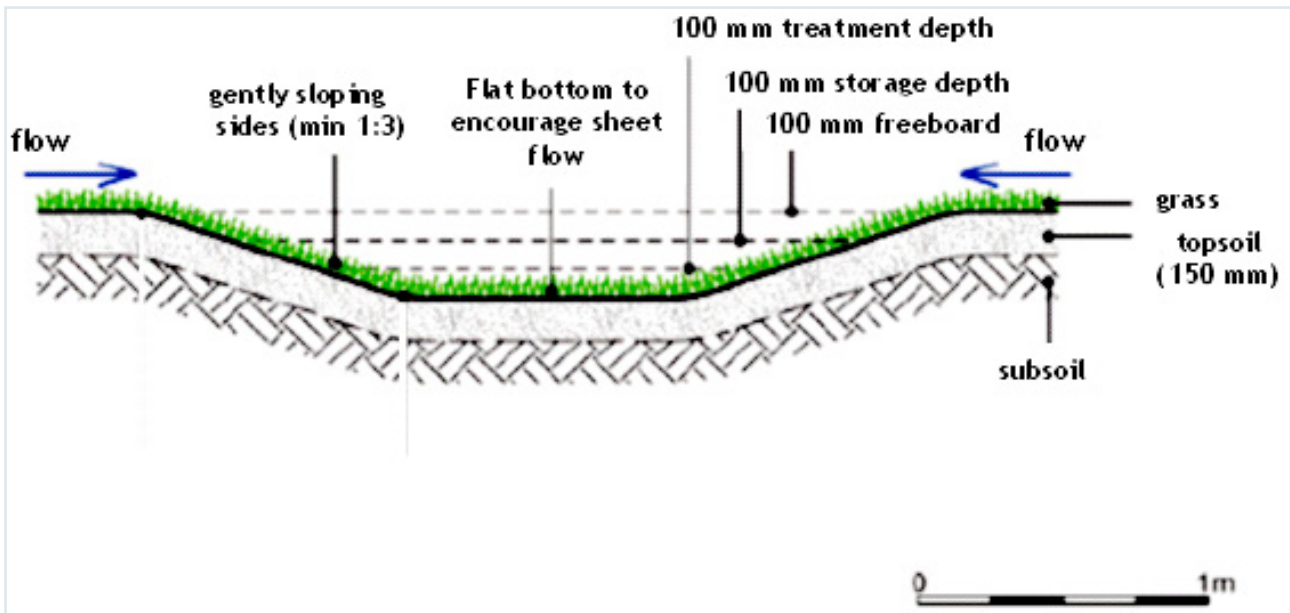

Figure 34: A schematic diagram of a vegetated swale (Anglian Water).

Swales provide good cleaning capacities and need less space and a lower permeability of soil than surface infiltration. Water can be discharged through open gutters into the swale, which can be incorporated into landscaped areas.

Swales should be used as the first stage of a SUDS train, accepting diffuse runoff from adjacent impermeable or low permeable areas. As a result, the contributing catchment area tends to be relatively small, for example a roof surface, car park, road surface or a small field. The connected drainage area is the most decisive parameter. As a rule of thumb, the total surface area of a swale should be about 2 - 5% for low intensity rain events or 10 - 20% for high intensity rain events of the area that drains into the swale.

Swale vegetation can be a mixture of plants including wet and dry area grasses, which would increase biodiversity benefits.



Table 7: Optimal design parameters for vegetated swales.

<b>Required surface area</b>	Low intensity rain event: 2 - 5% of the connected drainage area High intensity rain event: 10 - 20% of the connected drainage area
<b>Width</b>	1 - 2.5 m
<b>Depth</b>	20 - 50 cm (usually 1/5 of the width)
<b>Longitudinal slope</b>	Minimum 1% and maximum 4%
<b>Subsurface</b>	Topsoil with substrate (usually grass): > 10 cm. For a good cleaning capacity approx. 30 cm are recommended



Figure 35: Vegetated swales (Büro Grimm).



Figure 36: Swales in residential areas (Sieker).

### 2.3.4. Infiltration basins

Infiltration basins are natural or constructed shallow, vegetated depressions that temporarily store and infiltrate stormwater runoff into the surrounding permeable soil over several days. They generally collect surface water runoffs from small areas. Infiltration basins are dry except in periods of heavy rainfall. They are similar to detention basins, which hold water only for a short period, except that they are designed to allow water to soak into the ground as well as provide storage.



## Thematic Catalogue 2 - PART 1

Vegetation should withstand wet and dry conditions and deep-rooted vegetation will improve the infiltration capacity of the basin and reduce the rate of clogging. Infiltration basins can be planted with trees, shrubs and other plants thus providing habitats for wildlife.

Infiltration basins can be incorporated into new developments, where existing vegetation can be preserved and utilised as the infiltration area. Runoff from adjacent buildings and impervious surfaces can be directed into this area, thereby increasing evapotranspiration in addition to encouraging infiltration.

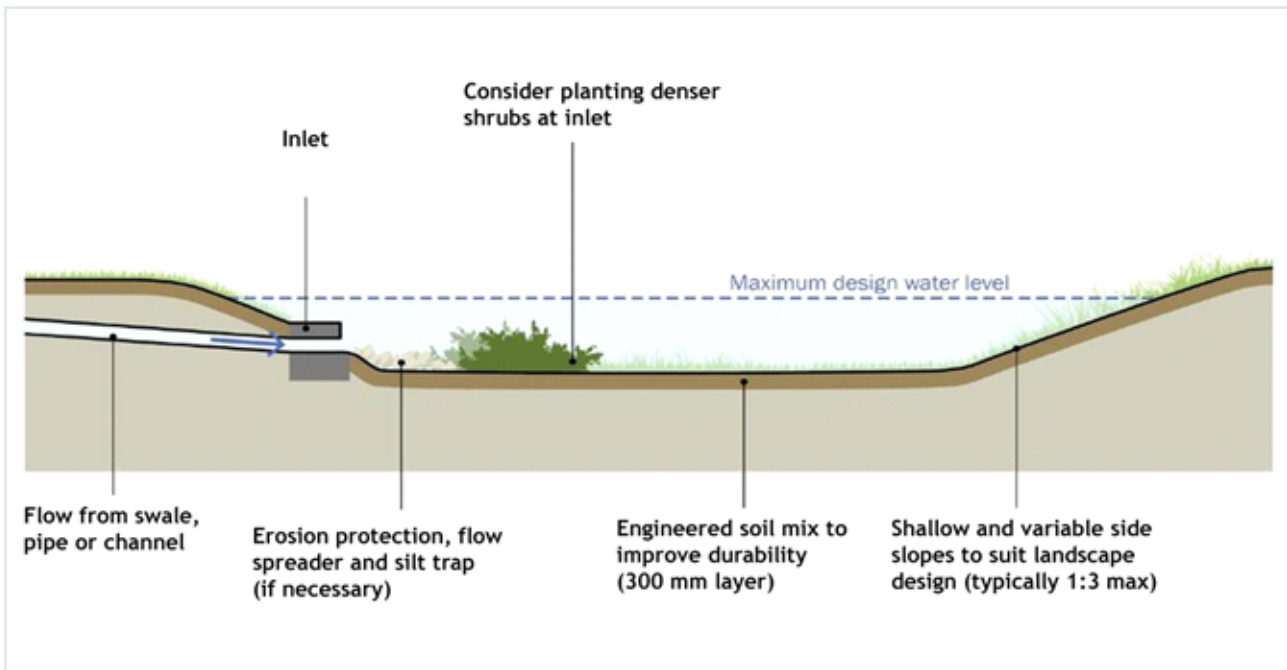

Figure 37: Schematic diagram of an infiltration basin (Anglian Water).



Figure 38: Empty<sup>37</sup> and filled infiltration basin<sup>38</sup>.

<sup>37</sup> [https://stormwater.pca.state.mn.us/index.php/BMPs\\_for\\_stormwater\\_infiltration](https://stormwater.pca.state.mn.us/index.php/BMPs_for_stormwater_infiltration)

<sup>38</sup> <https://www.stormwaterpartners.com/facilities-infiltration-basin>



### 2.3.5. Infiltration trenches

Infiltration trenches are linear, shallow excavations, which are filled with permeable granular material (gravel, lava granules or stone), or other material with large storage capacity (infiltration boxes) collecting surface water runoff from impermeable surfaces and filtering it gradually into the ground. Runoff is stored in the voids allowing it to slowly infiltrate into the ground, thus acting as a temporary underground storage reservoir. Their longevity is enhanced by incorporating an effective pre-treatment system (e.g. filter strip) to remove excess solids at the inflow. An infiltration trench drain can be topped with vegetation or with hardscaping materials such as gravel, brick or pavers. The collected rainwater is led above ground (surface drain) into a gravel-filled trench or underground (subsurface drain) into a gravel-bedded perforated pipe, where it is temporarily stored and from where rainwater gradually seeps into the ground (Figure 39). A control shaft with overflow and throttle devices are usually connected. This type of infiltration requires little space, but it is difficult to control the underground system.

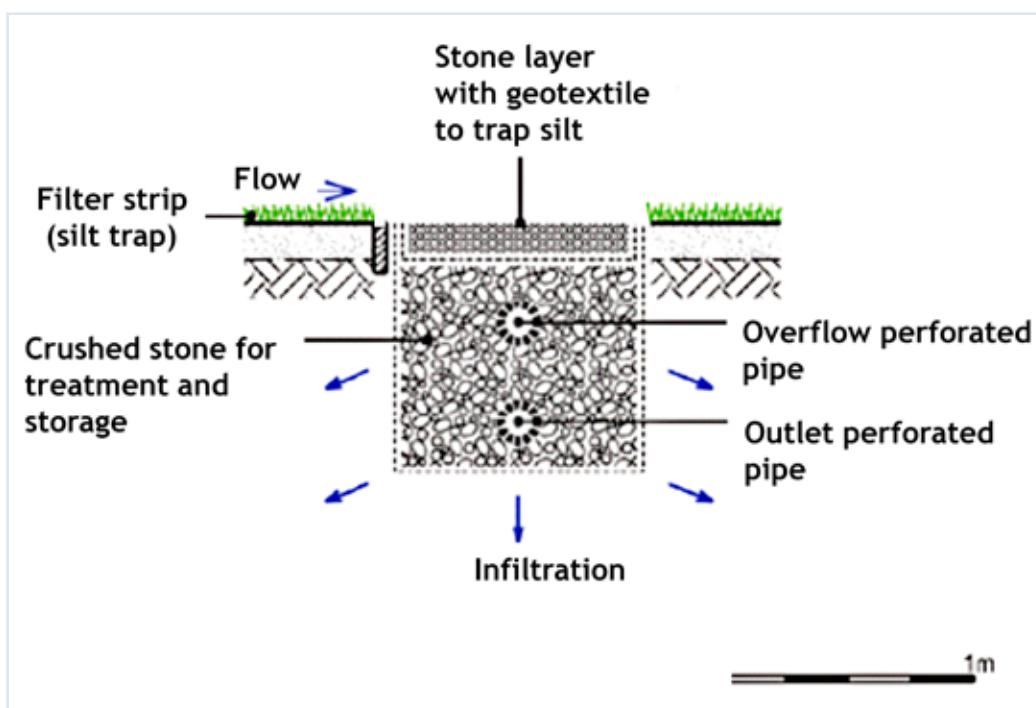

Figure 39: A schematic diagram of an infiltration trench with stone reservoir and perforated drainpipes (Anglian Water).

The infiltration trench is usually wrapped within a geotextile membrane to prevent contamination of the filling material with topsoil. It should have a diffused inlet along the length of the trench and potential for emergency overflow provision in extreme events. Cleanouts or inlets should be installed at both ends of the infiltration trench and at appropriate intervals to allow access to the perforated pipe. Trenches should be able to drain and re-aerate between rainfall events. With long infiltration trenches it is advisable to provide inspection tubes at regular intervals along the trench. Infiltration trenches should be integrated into overall landscape design and open spaces which allow for dual use of land. Due to their narrow shape, they are easy to integrate into a site with minimal land requirement.



Figure 40: Examples of infiltration trenches<sup>39</sup>.

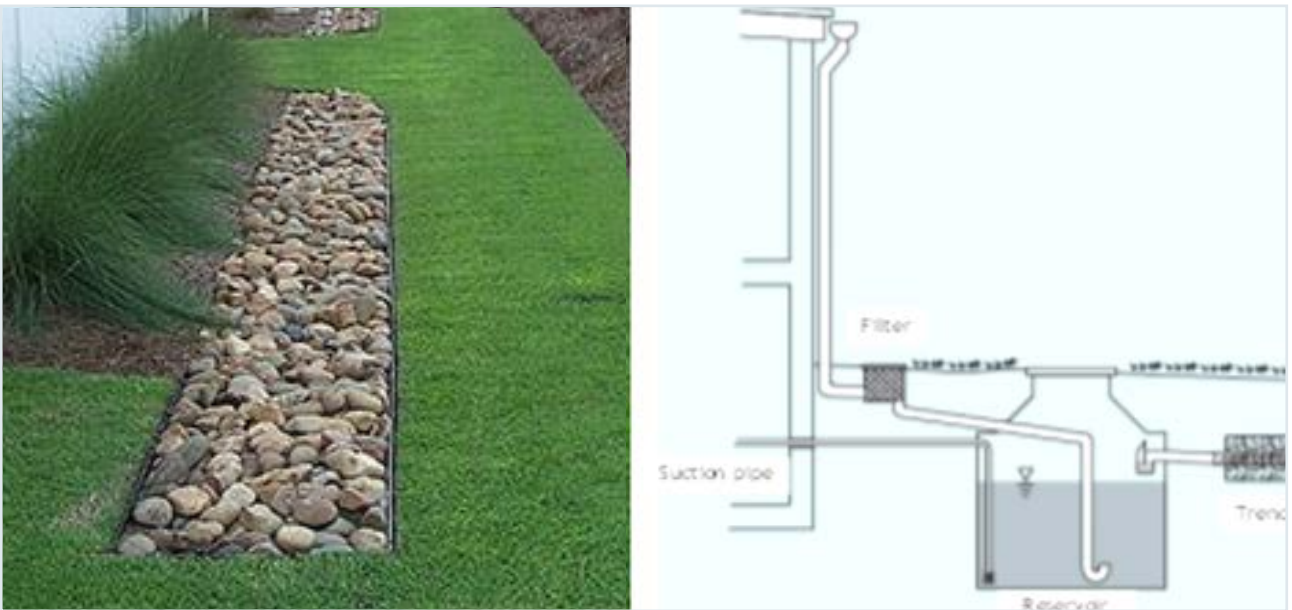

Figure 41: An infiltration trench with connection to roof<sup>40</sup>.

39 Minnesota Stormwater Manual. <https://sustainablestormwater.org/2007/05/23/infiltration-trenches/>  
40 <https://www.sudswales.com/types/source-control/infiltration-trenches/>



### 2.3.6. Swale-trench infiltration

The swale-trench infiltration is a combination of surface retention and cleaning of a swale and the underground retention of a trench. It provides good cleansing capacities and requires less space than surface or swale infiltration. Rainwater passes through the topsoil of the swale into a permeable trench zone, where it is either infiltrated into deeper layers or throttled to a river or sewer. Swale-trench systems are particularly suitable where space is limited and soils are moderately permeable.

The construction of a swale-trench system includes the following components (Figure 42):

- Topsoil layer (30 cm) and gravel layer (5 cm) between swale and infiltration trench
- A trench as a storage reservoir filled with gravel (grain size 16/32) and a drainpipe or a packed bed trench made from infiltration boxes
- Throttle shaft with throttle element at the end of the drainpipe
- An overflow.

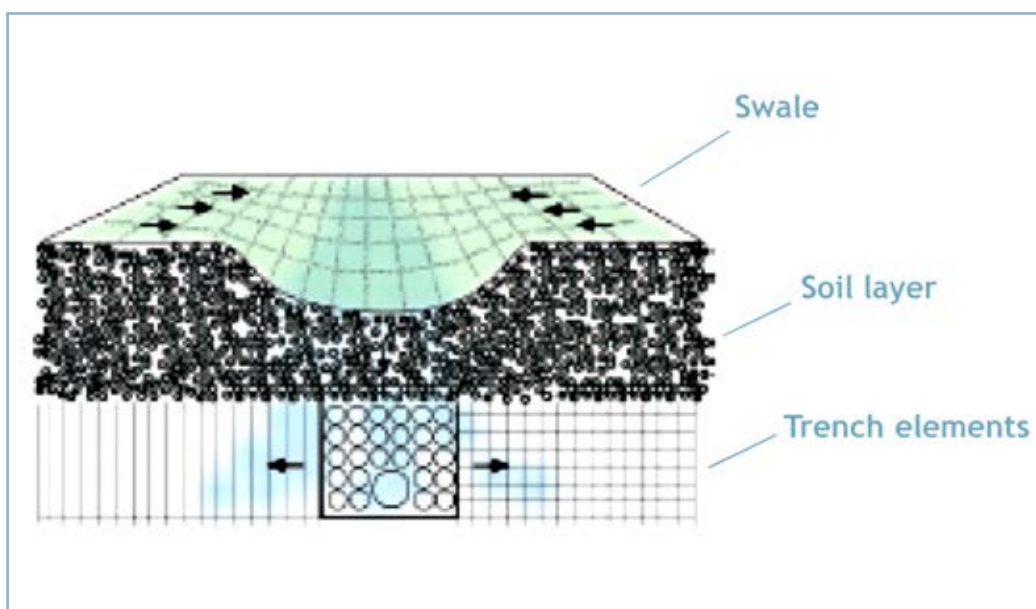

Figure 42: Cross section in a swale-trench infiltration system (Adapted from fbr).

Both the above ground swale and the underground trench provide for storage space. An emergency overflow from the swale to the infiltration trench effects a relief on the swale during hydraulic peak loads. At the end of the drainpipe in the infiltration trench, a throttle element ensures a throttled discharge of the rainwater into the sewer or a surface water body.

The surface requirement for swale-trench systems is approx. 10% of the connected, sealed surface and they require less space than swale or trench systems alone. Swale-trench systems are typically used for poorly permeable topsoils ( $k_f < 10^{-6}$  m/s as in clay soils), where infiltration rates of only 50% are usually achieved. The swale ensures extensive cleaning of the rainwater before it enters the trench. Sealing of the swale-trench system with a geotextile membrane protects the system from blockages through topsoil.





Figure 43: Trench elements (infiltration boxes) for swale-trench infiltration systems (ENREGIS).



Figure 44: Swale-trench systems in Berlin (Sieker).

The performance of a swale-trench system is that of swale and trench systems combined. Studies have shown that the swale-trench system meets most design objectives, including substantial reductions in total runoff and peak flow rates, removal of contaminants and increased groundwater recharge.



### 3. Overview matrix of different rainwater management measures

Table 8: Space requirement for different rainwater measures (Adapted from Sieker, 1999)<sup>41</sup>.

Measure	Space requirement (m <sup>2</sup> /ha)
Rainwater harvesting (RWH)	400
Green roofs	0
Permeable pavings	0
Surface infiltration	5,000
Swale infiltration	2,000
Trench infiltration	1,200
Swale-trench infiltration	1,000
Soakaways	100

<sup>41</sup> Sieker, H. (1999) Generelle Planung der Regenwasserbewirtschaftung in Siedlungsgebieten. Dissertation. Technische Universität Darmstadt  
[https://www.sieker.de/aktuelles/news/generelle-planung-der-regenwasserbewirtschaftung-in-siedlungsgebieten-dissertation-technische-universitaet-darmstadt-166.html?no\\_cache=1](https://www.sieker.de/aktuelles/news/generelle-planung-der-regenwasserbewirtschaftung-in-siedlungsgebieten-dissertation-technische-universitaet-darmstadt-166.html?no_cache=1)



Thematic Catalogue 2 - PART 1

Table 9: Potentials and impacts of different measures for rainwater management.

LEGEND														
	High													
	Medium													
	Low													
	None													
	Rainwater harvesting (RWH)	Green roofs & walls	Rain gardens	Retention ponds	Constructed wetlands	Detention basins	Permeable/porous pavings	Filter strips	Vegetated swales	Infiltration basins	Infiltration trenches			
Flood control reduction														
Water retention														
Slow runoff														
Store runoff														
Filtration of pollutants														
Increase evapotranspiration														
Increase infiltration														
Intercept pollution pathways														
Erosion control														
Groundwater recharge														
Climate change mitigation														
Reduce peak temperatures														
Create aquatic habitat														
Biodiversity enhancement														
Amenity potential														
Recreational value														



## 4. Best practice

### 4.1. Rainwater harvesting Belß-Lüdecke residential area, Berlin

Construction period: 2000 - 2001

In the Belß-Lüdeckestraße residential area in Berlin, the polluted portion of the rainwater (the so-called “first flush”) originating from roofs, courtyards and surrounding traffic surfaces of a residential complex is diverted, collected and treated using planted soil filters followed by UV disinfection. The treated rainwater is used to flush the residents’ toilets and to water the gardens. Only, the largely unpolluted rainwater portion enters the rainwater sewer and is discharged into the nearby surface water body. This project was the first of its kind, which harvested and treated rainwater from street runoffs for indoor use<sup>42</sup>.

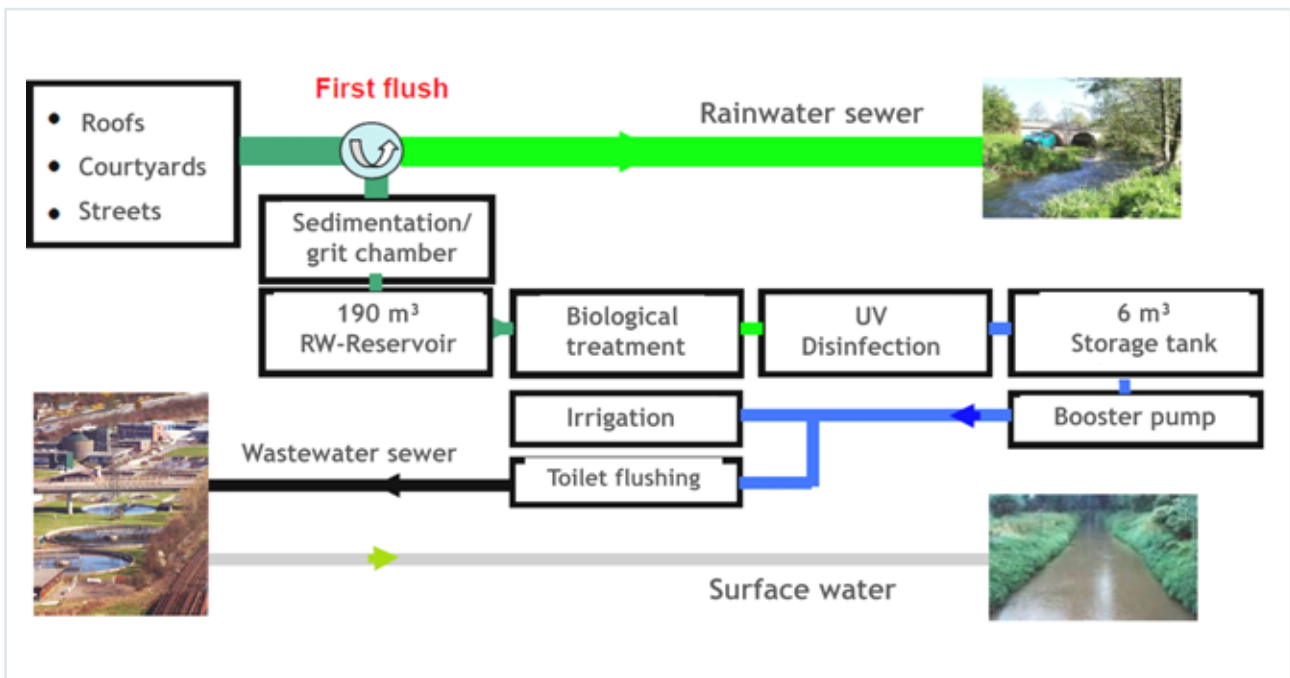

Figure 45: Flow diagram of the rainwater management scheme at Belß-Lüdecke residential area, Berlin.

42 Nolde, E. (2007) Possibilities of rainwater utilisation in densely populated areas including precipitation runoffs from traffic surfaces. Desalination 215 (1): 1-11



Table 10: Technical data.

Project: Rainwater harvesting Belß-Lüdecke Strasse, Berlin	
<b>Description</b>	The first project of its kind in Berlin, also harvesting and treating runoff from traffic surfaces for indoor use and producing high-quality service water
<b>Project start - end</b>	2000 - 2001
<b>Collection area</b>	Roof and courtyard surfaces, including sealed traffic surfaces
<b>Catchment area</b>	12,000 m <sup>2</sup> sealed area
<b>Rainwater reservoir</b>	190 m <sup>3</sup> ; rainwater is diverted from the rainwater sewer into the cistern (including first flush)
<b>Pre-treatment</b>	Sedimentation and grit chamber (sand trap)
<b>Biological treatment</b>	Planted soil filter and UV disinfection
<b>Treatment capacity</b>	10 m <sup>3</sup> /d
<b>Reuse applications</b>	Indoor toilet flushing (200 persons) and garden irrigation
<b>Drinking water-saving potential</b>	Approx. 70% of the water demand for toilet flushing (80 apartments): 2,500 m <sup>3</sup> /a

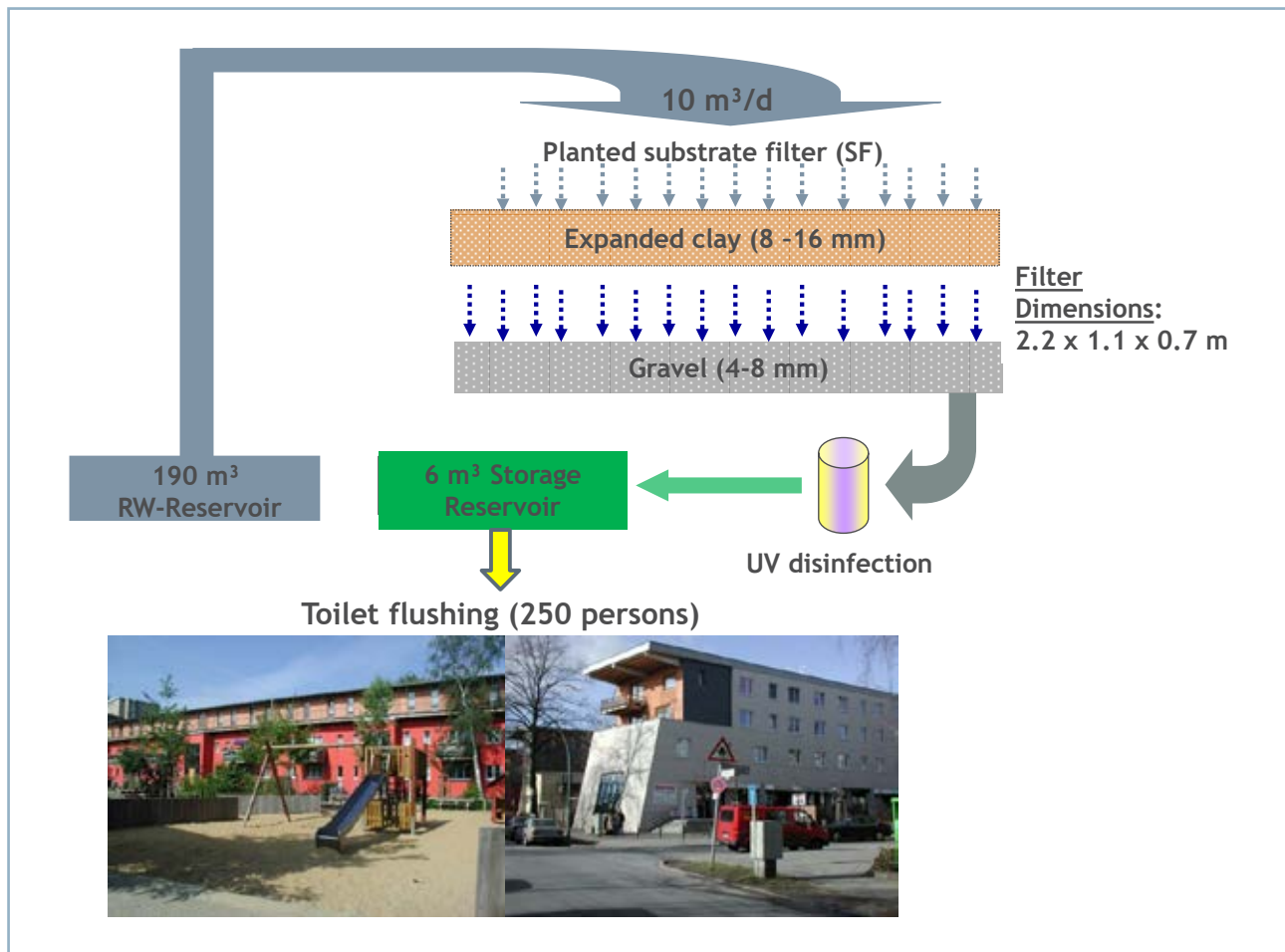

Figure 46: System design for the rainwater treatment system using planted soil filter.



Figure 47: Rainwater sewer with switch diversion (above) and planted soil filter inside the building (below).

## 4.2. Potsdamer Platz, Berlin

Construction period 1994 - 1999<sup>43,44</sup>

Rainwater management and urban water design: measures include rainwater harvesting, extensive and intensive green roofs, artificial water bodies and constructed wetland for rainwater treatment. The site manages approx. 23,000 m<sup>3</sup> of rainwater annually from 19 buildings.

A combination of green and non-green roofs harvest the annual rainwater, which is reused for toilet flushing, irrigation and fire-fighting. Excess rainwater flows into the pools and channels of the outdoor landscape creating an oasis for urban life. Vegetated biotopes are integrated into the site landscape forming a natural habitat and which serve to filter and clean the rainwater flowing into an artificial water body. Green roofs, underground cisterns and an artificial water body are the main water reservoirs.

43 <https://www.urbangreenbluegrids.com/projects/potsdamer-platz-berlin-germany/>

44 [https://www.stadtentwicklung.berlin.de/bauen/oekologisches\\_bauen/de/modellvorhaben/kuras/oekologischer-stadtplan.shtml](https://www.stadtentwicklung.berlin.de/bauen/oekologisches_bauen/de/modellvorhaben/kuras/oekologischer-stadtplan.shtml)



## Thematic Catalogue 2 - PART 1

The artificial water body with an area of 13,042 m<sup>2</sup> and a water volume of approx. 15,000 m<sup>3</sup> is divided into four functionally distinguishable water bodies. Cleaning and filtering of the rainwater follows naturally through the 4 biotopes, which are built as modified constructed wetlands consisting of a special substrate of expanded shale, gravel and zeolite and planted with common reed (Phragmites). The water circulates continuously with a maximum filtering capacity between 30 and 150 m<sup>3</sup>/h for the different biotopes.

### Main features:

- Onsite management of rainwater
- Retention and evaporation of the rainwater via a predominantly extensive roof greening (12,000 m<sup>2</sup>)
- Cisterns with a total volume of 2,550 m<sup>3</sup>:
  - use for toilet flushing approx. 10,800 m<sup>3</sup>/a
  - use for green space irrigation approx. 1,114 m<sup>3</sup>/a
  - use for replenishment of artificial water body approx. 12,000 m<sup>2</sup>, with upstream planted purification biotopes of approx. 1,900 m<sup>2</sup>

During extreme events (every 2-3 years), the collected rainwater is throttled into the Landwehrkanal with a maximum of 3 litres/s/ha.

Impacts: rainwater is harvested and utilised on site such that no rainwater enters the combined municipal sewer. The urban waterscape at the Potsdamer Platz reduces the risk of floods and surface water pollution. It also closes the water cycle via evaporation from green roofs and the artificial lake, thus improving the local microclimate. Freshwater use in buildings was reduced and an increase in urban biodiversity as well as resource efficiency was recorded.



Figure 48: Potsdamer Platz, Berlin (Photos: Ramboll Studiodreiseitl, above and Marco Schmidt, below).





### 4.3. Olympia Stadium, Berlin

#### Reconstruction and roofing work completed in 2004.

Various technical measures have been implemented to conserve resources and environment at the Olympia Stadium in Berlin. These included: a rainwater cistern and a well, adjustment of urinal flushing times and switching to waterless urinals in highly frequented areas, reduction of flow rates at flush valves.

Rainwater is collected from the roof of the Stadium and stored in an underground cistern. All green areas of the stadium are irrigated with harvested rainwater.

The rainwater from roof is completely managed on site and used for the irrigation of the playing field, while the rest is infiltrated. For this purpose, three underground infiltration trenches were constructed.

Rainwater from the stand roofing is stored in the underground concrete cistern with a capacity of approx. 1,700 m<sup>3</sup>. About 1,400 m<sup>3</sup> of the cistern water are used for lawn irrigation. For each irrigation session, at least 150 m<sup>3</sup> are sprinkled onto the playing field in order to achieve sufficient moisture penetration of the turf.

Technical data of the Berlin Olympic Stadium following reconstruction:

- 42,000 m<sup>2</sup> drained area (stand roofing)
- 20,000 m<sup>2</sup> drained directly via filter shafts to the infiltration trenches
- 22,000 m<sup>2</sup> of roof area connected to the cistern, overflow to infiltration trench system
- 1,700 m<sup>3</sup> rainwater storage volume, of which 330 m<sup>3</sup> are retention volume
- 1,400 m<sup>3</sup> usable storage volume.

The three underground infiltration elements of the trench system are made of plastic infiltration boxes placed over each other in several layers to form a hollow body (Dimensions: L x W x H 1000 x 500 x 400 mm). The entire infiltration trench is wrapped with a geotextile to ensure stability and protect it from surrounding soil.

The trench elements are placed on a subgrade of 10 cm sand or gravel (2/8 mm) and are covered on top with a 2 mm thick PE protective membrane. The hollow space is filled with rounded gravel (8/16 mm). The water-storing cavities take up around 95% of the total volume, almost three times the size of gravel. Filter shafts (2.5 - 3 m in diameter) are installed upstream of each infiltration trench. A front panel made of a stainless-steel sieve (mesh size 0.6 mm) retains the sediment carried in rainwater.



Figure 50: Berlin Olympia Stadion with stand roofing from where rainwater is collected (left) and underground rainwater cistern with different storage space levels<sup>45</sup>.

## 4.4. Berlin-Brandenburg International Airport (BBI)

### Completed in 2020.

The airport company maintains a wastewater network with numerous pumping stations and pre-treatment facilities. In addition to the terminal, all other airport buildings are connected to this sewer network, which is operated with separate pipe networks for wastewater and stormwater. The wastewater is treated at the Waßmannsdorf wastewater treatment plant operated by the Berliner Wasserbetriebe. Rainwater is collected, treated and discharged separately.

Rainwater from roofs and parking lots, which is usually low polluted is infiltrated as close to the point of origin as possible. Rainwater discharges from runways, taxiways and apron taxiways, which may be contaminated with surface de-icing agents during Winter, is pre-treated with light-liquid separators followed by a soil filter. In Summer, rainwater is discharged without pre-treatment into an infiltration swale or infiltrated on the airport premises.

To equilibrate the stormwater runoff, a retention volume of approx. 180,000 m<sup>3</sup> was designed using a 28 km rainwater sewer with 8 pumping stations and capacities up to 5,000 l/s. Rainwater is discharged into the infiltration trench at a rate of 1,000 litres per second. Non-polluted rainwater is either discharged into two receiving bodies (Glasowbach, the eastern Selchower flood pit) or re-infiltrated into the ground.

<sup>45</sup> [https://www.stadtentwicklung.berlin.de/bauen/oekologisches\\_bauen/de/modellvorhaben/kuras/oekologischer\\_stadtplan.shtml](https://www.stadtentwicklung.berlin.de/bauen/oekologisches_bauen/de/modellvorhaben/kuras/oekologischer_stadtplan.shtml)

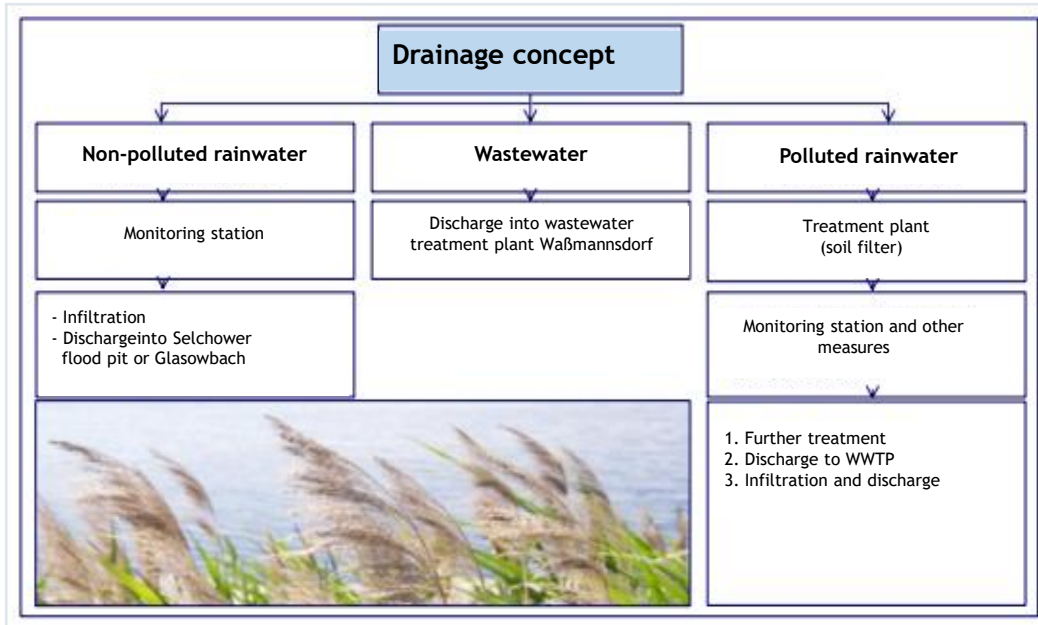

Figure 51: The new Berlin-Brandenburg International Airport drainage concept

## 4.5. Hamburg Water Cycle® (HWC)

Start of construction: 2020

The Hamburg Water Cycle® (HWC)<sup>46</sup> is an innovative and holistic wastewater and energy concept that has been developed by HAMBURG WASSER, the municipal water and wastewater utility which provides drinking water and sanitation services to more than 2 million customers in the metropolitan region of Hamburg since more than 150 years. The HWC offers a concept for decentralised wastewater management recovering also nutrients and generating renewable energy. It aims at separating the household wastewater into three effluent flows (rainwater, greywater and blackwater) which

<sup>46</sup> <https://www.hamburgwatercycle.de/en/hamburg-water-cycler/>



## Thematic Catalogue 2 - PART 1

will be treated separately. The HWC seeks to close the material and energy loops with sustainable concepts and energy-efficient technologies, which can be integrated into the existing system.

The main feature of the HAMBURG WATER Cycle® is the separation of the different wastewater streams and subsequent recovery of energy from wastewater. This will be implemented in Hamburg at two locations on a small scale and on a larger scale.

On a small scale: The “Gut Karlshöhe” is a 9-acre environmental theme park, created by the Hamburg Climate Protection Foundation for educational purposes. Also of particular interest is the wetland for greywater treatment which is located on its premises. Rainwater will be harvested on site to generate a water source for domestic needs.

On a large scale: The neighbourhood of Jenfelder Au will be the first neighbourhood in Hamburg where the HWC will be incorporated on a large scale on 35 acres for approx. 2,000 residents. Rainwater will also become a creative element for open landscape design. The Jenfelder Au is a pilot project of the “National Urban Development Policy” of the Federal Ministry of Building and Urban Development (BMVBS) and the Federal Institute of Building, Urban Affairs and Spatial Development (BBSR).

The Jenfelder Au stormwater management concept decouples rainwater from the sewer network, allowing it to flow through open channels and waterfalls to retention basins constructed as attractive ponds and lakes. The retention basins are designed to provide storage potential in case of heavy rainfall. The value of the residential area will be enhanced and flood protection optimised.

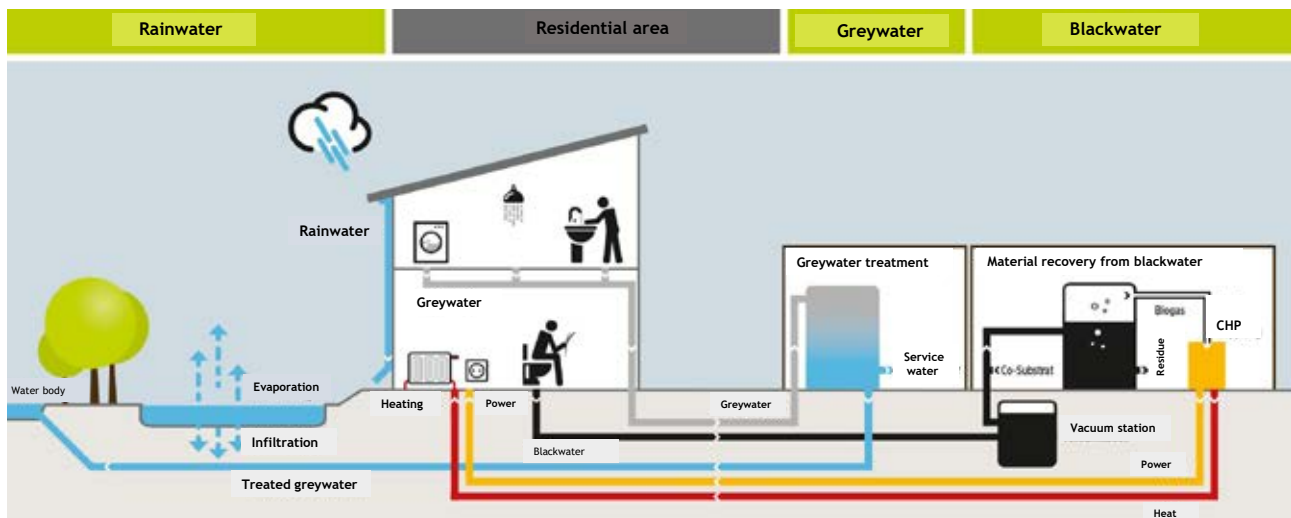

Figure 52: The Jenfelder-Au neighbourhood concept in Hamburg showing the different wastewater streams<sup>47</sup>.

<sup>47</sup> <https://www.hamburgwatercycle.de/en/the-jenfelder-au-neighbourhood/the-hwc-in-the-jenfelder-au/>



## 4.6. Emscher-genossenschaft

The Emscher-genossenschaft is the first German water management association founded in 1899 in the Federal State of North Rhine-Westphalia, with the objective of creating ecological, technical and design solutions for the Emscher River in this region. In Europe's largest metropolitan area, between Dortmund and Duisburg, with 865 km<sup>2</sup> catchment area, the Emscher-genossenschaft is responsible for all issues related to the Emscher and its subsidiary waterways including surface water body maintenance, flood protection, wastewater disposal, stormwater and groundwater management, as well as the renaturalisation of the Emscher River. About 2.2 million people live in the Emscher catchment area, between its source and its confluence with the Rhine.

The Emscher River catchment area in Germany is one of Europe's most densely populated and industrialised areas due to the impact of mining activities from the beginning of the 19th century. The Emscher system was developed as an open sewer system in which freshwater as well as wastewater flowed. With the ceasing of the mining activities in the 1980's an opportunity for a restoration of the Emscher catchment emerged. Due to the high level of urbanisation the flow regime of the Emscher is strongly influenced by stormwater runoff. In addition, overflows of the dominantly combined sewer system caused water quality problems and hydraulic stress. Aware of these problems, the Emscher Association (Emscher-genossenschaft) introduced new source-oriented stormwater management strategies since the 1990's for the revitalisation and upgrading of the Emscher River Basin<sup>48</sup>.

Establishing natural rainwater management is a major component of the Emscher conversion's success. With the "Future convention for rainwater" (Zukunftsvereinbarung Regenwasser), all the cities in the Emscher region, the Ministry for the Environment and the Emscher-genossenschaft have set goals to reduce the inflows of rainwater and clean water into the municipal drainage system by 15% within 15 years, from 2005 to 2020. Various measures by public and private property owners are contributing towards this with support from the funding programme of the Emscher-genossenschaft and the federal state North Rhine-Westphalia<sup>49</sup>.

The subsidies amounted to € 5/m<sup>2</sup> of sealed area disconnected from the drainage system. Since 1994, 19 member municipalities have participated with a total of 82 different projects, of which 47 projects have been already implemented. With this level of disconnection, the flood peak flow in the tributaries of the Emscher could be reduced by as much as 40 %, which is of immense ecological importance.

The Emscher-genossenschaft have shown, that rainwater harvesting can also be part of public open space design. With citizen participation and support of construction companies, schools and day care centers, 12% of the area was successfully decoupled.

Further publications (only German) under:

<https://emscher-regen.de/index.php?id=8>

<https://emscher-regen.de/index.php?id=43>

48 Becker, M. & Raasch, U. (2001) Sustainable rainwater management in the Emscher river catchment area. Proceedings of the 2nd International Conference on Interactions between Sewers, Treatment Plants and Receiving Waters in Urban Areas (Interurba II). Lisbon, Portugal, 19-22 February

49 Emscher 3.0 From grey to blue - Or how the blue sky over the Ruhr region fell into the Emscher (2013). Wuppertal Institut für Klima, Umwelt, Energie GmbH (Publisher). <https://climate-adapt.eea.europa.eu/metadata/case-studies/a-flood-and-heat-proof-green-emscher-valley-germany/11305620.pdf/view>



## 4.7. KURAS - Concepts for urban stormwater management, drainage and sewage systems

Research project: Duration: 2013 - 2016

The research project KURAS<sup>50</sup>, funded by the German Federal Ministry for Education and Research (BMBF), aimed at the development and demonstration of integrated concepts for the sustainable treatment of wastewater and stormwater in urban districts in view of the increasing demographic and climate changes that are impacting the existing sewer networks. Within the scope of this project, guidelines for municipalities and operators of sewer networks featuring low downhill gradients were developed to facilitate operation, expansion and modification of the existing technical wastewater infrastructure according to future needs.

Concepts for sustainable stormwater management in urban districts were developed by:

- comparing centralised and decentralised stormwater management schemes with regard to their impact on the environment, urban climate, building physics and costs
- optimising the combination of stormwater measures for districts, small cities and metropolises for the existing building stock and developing new areas based on their applicability
- considering future changes
- demonstrating these measures by means of two model districts in Berlin
- generating recommendations for sustainable financing models and basic regulatory measures.

For rainwater management, two urban districts with an area of approx. 1 km<sup>2</sup> each were defined, one with combined sewer and the other with separate sewer.

The quantitative and qualitative assessment of 27 different stormwater management measures were presented in the form of fact sheets (in German), which also included design and function of each measure, rules and regulations, key performance indicators as well recommendations on maintenance. The measure profiles are addressed to authorities and water utilities as well as to planners and owners.

## 4.8. The Gorla Maggiore Water Park (combined sewer overflow treatment)

Gorla Maggiore is a municipality of ca. 5000 inhabitants in the Lombardy Region, northern Italy. The Gorla Maggiore Water Park consists of a set of constructed wetlands (CW) for the treatment of overflow water from a mixed sewer system, surrounded by a park on the shore of the Olona River. It was built in 2011-2012 with a whole surface area of 6.5 ha.

The intervention aims to resolve the impacts of the combined sewer overflow on the Olona River, both in terms of quality and hydraulic peaks, and to create a new river area that can be used by the population. All overflow waters, including those of first rain, are purified within the system: first

<sup>50</sup> KURAS. Concepts for urban rainwater management, drainage and sewage systems. Research project: 2013-2016. Funded by the German Federal Ministry of Education and Research under the funding measure "Smart and Multifunctional Infrastructural Systems for Sustainable Water Supply, Sanitation and Stormwater Management" (INIS). In German. <http://www.kuras-projekt.de/index.php?id=78>



## Thematic Catalogue 2 - PART 1

through preliminary automatic filtration treatments, then inside vertical subsurface flow constructed wetland vegetated with *Phragmites australis* (marsh reeds). Second rain waters are sent directly to a surface flow wetland/pond area, which is also designed as a detention basin for flood control (rain event with return period of 10 years). In addition to the constructed wetland system, which have made it possible to create wetlands enriched by a remarkable biodiversity of aquatic plants, the surrounding was designed as a park, with path, bicycle land, and rest area, positively judged and currently highly used by the Gorla Maggiore citizens. Being a multipurpose NBS, the Gorla Maggiore Water Park has proved to be highly effective in water pollution control<sup>51</sup>, flood mitigation<sup>52</sup>, as well as biodiversity and social benefits<sup>53, 54</sup>. The Gorla Maggiore Water Park was one of the 27 case studies of the OpenNESS project (FP7 - [www.openness-project.eu](http://www.openness-project.eu)) and mentioned as one of the ten best Italian projects in the water management sector at the Italian Award for the sustainable development 2017.



Figure 53: Aerial view and map of the study area<sup>55</sup>.

51 Masi, F., Rizzo, A., Bresciani, R. and Conte, G., 2017. Constructed wetlands for combined sewer overflow treatment: ecosystem services at Gorla Maggiore, Italy. *Ecological Engineering*, 98, pp.427-438

52 Rizzo, A., Bresciani, R., Masi, F., Boano, F., Revelli, R. and Ridolfi, L., 2018. Flood reduction as an ecosystem service of constructed wetlands for combined sewer overflow. *Journal of Hydrology*, 560, pp.150-159

53 Reynaud, A., Lanzanova, D., Liqueste, C. and Grizzetti, B., 2017. Going green? Ex-post valuation of a multipurpose water infrastructure in Northern Italy. *Ecosystem services*, 27, pp.70-81

54 Liqueste, C., Udias, A., Conte, G., Grizzetti, B. and Masi, F., 2016. Integrated valuation of a nature-based solution for water pollution control. Highlighting hidden benefits. *Ecosystem Services*, 22, pp.392-401

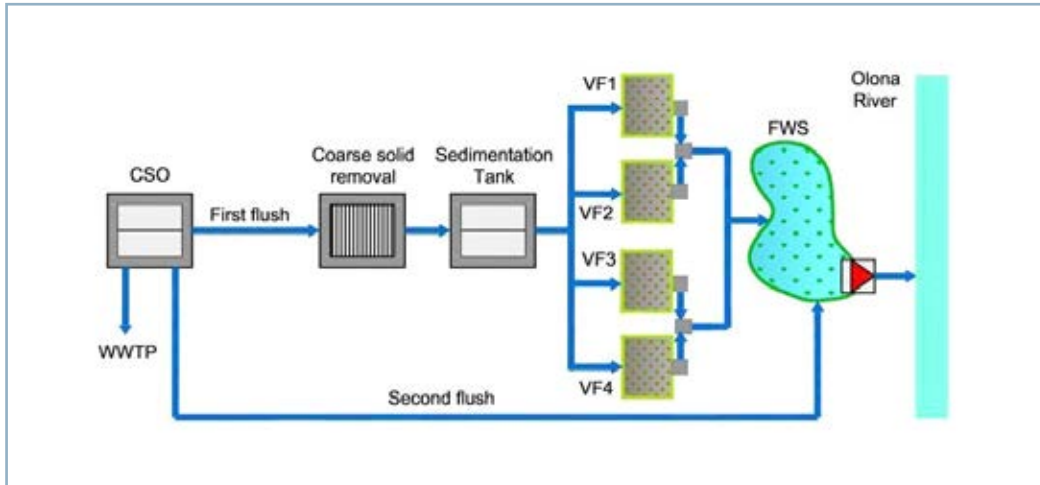

Figure 54: Schematization of the combined sewer overflow constructed wetland (CSO-CW) treatment plant<sup>52</sup>.



Figure 55: Photo of the Gorla Maggiore Water Park (Source: IRIDRA Srl - [www.igidra.com](http://www.igidra.com)).





Table 11: Project Data

Project: Rainwater harvesting Belß-Lüdecke Strasse, Berlin	
<b>Description</b>	Constructed wetlands for the treatment of overflow water from a mixed sewer system surrounded by a park
<b>Population Equivalent</b>	2000
<b>Water sources</b>	Combined sewer overflow
<b>Surface area</b>	6,5 ha
<b>Start of operation</b>	2013
Technical data	
<b>Treatment system</b>	Constructed Wetlands
<b>Treatment potential</b>	0,7 L/s
<b>Flood retention volume</b>	7700 m <sup>3</sup>
<b>Pollution removal</b>	11,7 t/yr dissolved organic carbon 0,4 t/yr nitrogen
<b>Costs</b>	900.000 eur for construction 29.590 eur for maintenance (20 yrs)



## 4.9. Retention soil filter (RSF) system at Berlin-Adlershof

At the Berlin-Adlershof site, a stormwater management concept was established for the Adlershof Technology Centre and the adjacent residential and commercial complexes. As part of a drinking water catchment area and with specific regulations for discharge into the Teltow Canal as a receiving water body, this site was treated with a retention soil filter system (RSF).

Commissioned in 2005, the soil filter treats a catchment area of 135 ha. Approximately 330,000 m<sup>3</sup> of rainwater from sealed surfaces such as streets, sidewalks and other open spaces are filtered annually<sup>55</sup>.

The collected runoff is initially discharged into a storage basin (530 m<sup>3</sup>) to allow the sedimentation of solids found in rainwater. Water is then pumped onto the filter surface planted with reeds. During passage through the mineral substrate layer, pollutants in the rainwater are filtered out and reduced up to 90% as a result of the chemical and biological processes. The filter substrate is also suitable for binding phosphorus due to the addition of ferrous material. The retention of heavy metals is also about 90%. The retention soil filter is divided into two filter units with a total filter surface area of 5,800 m<sup>2</sup> (72.5 m<sup>2</sup> filter surface/ha), which is fed at a rate of up to 1,200 l/s. The hydraulic load of the RBF is 50 m<sup>3</sup>/(m<sup>2</sup>/a). The discharge from the soil filter is throttled at 90 l/s. After passage through the soil filter, the treated rainwater is released into the Teltow Canal.



Figure 56: Retention soil filter (RSF) at Berlin-Adlershof (Source: BWB).

<sup>55</sup> <https://www.berlin.de/sen/uvk/umwelt/wasser-und-geologie/regenwasser/regenwasserbewirtschaftung/>



## 5. Additional Bibliography

Anglian Water. Towards sustainable water stewardship. Sustainable drainage systems (SUDS) adoption manual. Anglian Water Services limited.

[https://www.anglianwater.co.uk/siteassets/developers/aw\\_suds\\_manual\\_aw\\_fp\\_web.pdf](https://www.anglianwater.co.uk/siteassets/developers/aw_suds_manual_aw_fp_web.pdf)

Berlin - Innovative Water Concepts - Service water utilisation in Buildings (2007). Berlin Senate Department for Urban Development.

[https://www.stadtentwicklung.berlin.de/bauen/oekologisches\\_bauen/download/modellvorhaben/betriebswasser\\_englisch2007.pdf](https://www.stadtentwicklung.berlin.de/bauen/oekologisches_bauen/download/modellvorhaben/betriebswasser_englisch2007.pdf)

Dierkes, C., Lucke, T. and Helmreich, B. (2015) General Technical Approvals for Decentralised Sustainable Urban Drainage Systems (SUDS) - The Current Situation in Germany. Sustainability 2015 (7), 3031-3051.

DIN EN 16941-1 (2018) On-site non-potable water systems - Part 1: Systems for the use of rainwater. Beuth Verlag

DIN 1989-100 (2020) Rainwater harvesting systems - Part 100: Regulations in connection with DIN EN 16941-1 (Draft version)

DWA-A 138E (2005) Planning, Construction and Operation of Facilities for the Percolation of Precipitation Water. German Association for Water, Wastewater and Waste (DWA), Hennef.

Freisinger, U. B., et al. (2015) There's something growing on the roof. Rooftop greenhouses. Idea, Planning, Implementation. Leibniz Centre for Agricultural Landscape Research (ZALF), Müncheberg.

[https://www.stadtentwicklung.berlin.de/bauen/oekologisches\\_bauen/de/download/index.shtml](https://www.stadtentwicklung.berlin.de/bauen/oekologisches_bauen/de/download/index.shtml)

iwater. Integrated Stormwater Management (iwater) Project. <http://www.integratedstormwater.eu/>

Liu, J., Sample, D.J., Bell, C. and Guan, Y. (2014) Review and research needs of bioretention used for the treatment of urban stormwater. Water 6 (4): 1069-1099.

Naumann, S., McKenna, D., Iwaszuk E., Freundt, M. and Mederake, L. (2020) Addressing climate change in cities - Policy instruments to promote urban nature-based solutions. Ecologic Institute and Sendzimir Foundation 2020.

netWORKS (2019) Infokarten für die Planung blau-grün-grauer Infrastrukturen. netWORKS 4 - Resilient networks: Beiträge städtische Versorgungssysteme zur Klimagerechtigkeit. Forschungsverbund netWORKS.

<https://networks-group.de/de/networks-4/infokarten.html>

Pennsylvania Stormwater Best Management Practices Manual, 2006.

<https://pecpa.org/wp-content/uploads/Stormwater-BMP-Manual.pdf>

Radic, M, Brkovic Dodig, M. and Auer, T. (2019) Green facades and living walls. A review establishing the classification of construction types and mapping the benefits. Sustainability, 11: 4579-4601.



## Thematic Catalogue 2 - PART 1

Semaan M, Day, S.D., Garvin, M, Ramakrishnan, N, Pearce, A. (2012) Optimal sizing of rainwater harvesting systems for domestic water usages: A systematic literature review. Resources, Conservation and Recycling, Volume 6.

UNEP (2014) Green infrastructure: Guide for water management.

WWDR (2018) Nature-based Solutions for Water. The United Nations World Water Development Report 2018.

<https://unesdoc.unesco.org/ark:/48223/pf0000261424>

Zhang, D., Gersberg, R.M., Ng, W.J. and Tan, S.K. (2017) Conventional and decentralized urban stormwater management: A comparison through case studies of Singapore and Berlin, Germany. Urban Water Journal 14(2):113-124.



# Content | Part 2: Greywater Recycling

<b>1. INTRODUCTION</b>	<b>127</b>
1.1. WATER REUSE REGULATIONS IN THE EU	127
<b>2. WHAT IS GREYWATER?</b>	<b>130</b>
2.1. GREYWATER REUSE GUIDELINES AND REGULATIONS	130
2.2. GREYWATER CHARACTERISTICS AND COMPOSITION	132
2.2.1. Organic pollution	134
2.2.2. Nutrients in greywater	136
2.2.3. Pathogens in greywater	136
2.3. REQUIREMENTS FOR GREYWATER RECYCLING	137
2.3.1. Quality requirements	137
2.3.2. Technical requirements	138
2.3.2.1. Dual-pipe system	138
2.3.2.2. Backup water supply	139
2.3.2.3. Pumps	139
2.3.2.4. Control panel	140
2.3.3. Installation requirements	140
2.3.4. Operational requirements	140
2.3.5. Maintenance requirements	141
2.4. APPLICATIONS FOR RECYCLED GREYWATER	141
2.5. BENEFITS OF GREYWATER RECYCLING	142
2.6. RISKS OF GREYWATER RECYCLING	142
<b>3. GREYWATER MANAGEMENT AND TREATMENT</b>	<b>143</b>
3.1. GREYWATER TREATMENT TECHNOLOGIES	144
3.1.1. Physical treatment (Pre-treatment)	146
3.1.2. Chemical treatment	147
3.1.3. Biological Treatment	147
3.1.3.1. Rotating biological contactors (RBCs)	148
3.1.3.2. Moving-bed biofilm reactor (MBBR)	149
3.1.3.3. Membrane bioreactors (MBR)	150
3.1.3.4. Nature-based solutions (NBS) for greywater treatment	152
3.2. DISINFECTION	155
3.3. MAINTENANCE	156



## Thematic Catalogue 2

### **PART 2**

3.4. PERFORMANCE	156
3.5. HEALTH ASPECTS	156
3.6. ENVIRONMENTAL IMPACT	157
3.7. ECONOMIC BENEFITS	157
<b>4. BEST PRACTICE</b>	<b>159</b>
4.1. “BLOCK 6” INTEGRATED WATER CONCEPT	159
4.2. ARNIMPLATZ	163
4.3. ARABELLA-SHERATON-HOTEL IN OFFENBACH	167
4.4. GREYWATER RECYCLING USING MEMBRANE BIOREACTOR IN A RESIDENTIAL BUILDING	169
4.5. KERACOLL “GREENLAB” NEAR SASSUOLO, ITALY	170
<b>5. ADDITIONAL BIBLIOGRAPHY</b>	<b>172</b>
<b>RAINWATER MANAGEMENT TOOLS - ANNEX</b>	<b>173</b>



# 1. Introduction

Water conservation, efficiency and reuse have become increasingly important in the past years as we continuously face serious problems including water shortages, reduced groundwater levels, extreme drought periods and changing climate patterns. The widespread water scarcity and the growing stress on water resources have prompted considerable interest to recycle water, in addition to water saving and application of water efficiency measures.

The principles of sustainable water management can help identify alternative water sources that can be exploited to meet the increasing water demand for applications that do not require potable water quality. The use of local water resources is also linked with the existing debate on urban sustainability which recognises the importance of local solutions and the key role of local governments and citizens in the search of sustainable development. This principle has been put into practice in Europe and elsewhere through the local Agenda 21<sup>1</sup>.

Today, wastewater is regarded as a valuable resource for water, energy and nutrients and wastewater recycling an alternative to the centralised end-of-pipe approach offering partial decentralised solutions and minimising environmental impacts. Wastewater can be separated and treated at source to achieve a closed loop water system. Part, if not all, of the water demand may be supplied by a stock of local water sources including rainwater, wastewater and greywater<sup>2</sup>.

Water recycling provides a highly effective urban water management strategy by reducing mains water demand and alleviating the problems associated with water shortages in urban areas. In this way, the local water cycles can be efficiently closed.

## 1.1. Water reuse regulations in the EU

Until recently, the EU legislation did not specify conditions for water reuse. Guidelines or standards which regulate water reuse at the European Union level were almost absent. However, EU legislation allows and encourages water reuse through two instruments:

- The Water Framework Directive (2000/60/EC, WFD)<sup>3</sup>:  
which establishes a legal framework to guarantee sufficient quantities of good quality water across Europe for different water uses and environmental quality. It lists water reuse as a possible measure to be included in the programmes of measures for each river basin
- The Urban Wastewater Treatment Directive (91/271/EEC, UWWTD)<sup>4</sup>:  
Article 12 requires that „treated wastewater shall be reused whenever appropriate“ and „disposal routes shall minimise the adverse effects on the environment“, with the objective of protecting the environment from the adverse effects of wastewater discharge.

1 Agenda 21. United Nations Conference for Environment and Development. Rio de Janeiro, 1992 <https://sustainabledevelopment.un.org/content/documents/Agenda21.pdf>

2 Domènech, L. (2011) Rethinking water management: From centralised to decentralised water supply and sanitation models. Documents d'Anàlisi Geogràfica 2011, vol. 57/2 293-310

3 [https://ec.europa.eu/environment/water/water-framework/index\\_en.html](https://ec.europa.eu/environment/water/water-framework/index_en.html)

4 [https://ec.europa.eu/environment/water/water-urbanwaste/legislation/directive\\_en.htm](https://ec.europa.eu/environment/water/water-urbanwaste/legislation/directive_en.htm)



## Thematic Catalogue 2 - PART 2

Despite the lack of water reuse criteria at EU level, 6 Member States have requirements in place on water reuse, either in legislation or in non-regulatory standards which vary significantly in their level of stringency. Cyprus, France, Italy, Greece and Spain have legislation setting requirements for water reuse, while Portugal has non-regulatory standards on the quality of reused water (Table 1).

Table 1: Different legislations and standards regulating water reuse in 6 EU Member States<sup>5</sup>.

Country	Standards reference	Issuing institution
<b>Cyprus</b>	Law 106 (I) 2002 Water and Soil pollution control and associated regulations KDP 772/2003, KDP 269/2005	Ministry of Agriculture, Natural resources and Environment Water development Department (Wastewater and reuse Division)
<b>France</b>	JORF num.0153, 4 July 2014 Order of 2014, related to the use of water from treated urban wastewater for irrigation of crops and green areas	Ministry of Public Health Ministry of Agriculture, Food and Fisheries Ministry of Ecology, Energy and Sustainability
<b>Greece</b>	CMD No 145116 Measures, limits and procedures for reuse of treated wastewater	Ministry of Environment Energy and Climate Change
<b>Italy</b>	DM 185/2003 Technical measures for reuse of wastewater	Ministry of Environment Ministry of Agriculture, Ministry of Public Health
<b>Portugal</b>	NP 4434 2005 Reuse of reclaimed urban water for irrigation	Portuguese Institute for Quality
<b>Spain</b>	RD 1620/2007 The legal framework for the reuse of treated wastewater	Ministry of Environment Ministry of Agriculture, Food and Fisheries, Ministry of Health

In May 2018, the European Commission put forward a proposal for a regulation, setting EU-wide standards that reclaimed water would need to meet in order to be used for agricultural irrigation, with the aim of encouraging greater use of reclaimed water and contributing to alleviating water scarcity (Proposal (2018) 337, 28.5.2018)<sup>6,7</sup>. The proposal, endorsed by the ENVI committee on 21 January 2020, was adopted at first reading by the Council on 7 April 2020. The new Regulation on minimum requirements for water reuse for agricultural irrigation has entered into force on 25 May

<sup>5</sup> Alcalde-Sanz, L. and Gawlik, B.M. (2014) Water reuse in Europe. Relevant guidelines, needs for and barriers to innovation: A synoptic overview. JRC Science and Policy Reports. European Commission, Joint Research Centre <https://publications.jrc.ec.europa.eu/repository/handle/JRC92582>

<sup>6</sup> <https://ec.europa.eu/transparency/regdoc/rep/1/2018/EN/COM-2018-337-F1-EN-MAIN-PART-1.PDF>

<sup>7</sup> Alcalde-Sanz, L. and Gawlik, B.M. (2017) Minimum quality requirements for water reuse in agricultural irrigation and aquifer recharge - Towards a legal instrument on water reuse at EU level. EUR 28962 EN, Publications Office of the European union, Luxembourg 2017, ISBN 978-92-97-77175-0, doi:10.2760/804116, JRC109291 <https://ec.europa.eu/jrc/en/publication/eur-scientific-and-technical-research-reports/minimum-quality-requirements-water-reuse-agricultural-irrigation-and-aquifer-recharge>





## Thematic Catalogue 2 - PART 2

2020<sup>8</sup>. The new rules will apply from 26 June 2023 and are expected to stimulate and facilitate water reuse in the EU.

The new Regulation on **minimum requirements** for water reuse applies **solely** for:

- Agricultural irrigation
- Aquifer recharge

In this Regulation:

- Responsibility lies by operators of reclamation plants
- Four water quality classes are defined on basis of relevant crop and irrigation methods
- Physico-chemical and microbiological parameters are defined
- A risk management approach and data transparency for water reuse are included
- Supply of reclaimed water is conditional on permits to be issued by competent authorities of the Member States.

Table 2 and Table 3 list the reclaimed water quality classes for agricultural irrigation in the EU (Regulation (EU) 2020/741), and the minimum reclaimed water quality requirements, respectively.

Table 2: Classes of reclaimed water quality and permitted agricultural use and irrigation method (Regulation (EU) 2020/741).

Minimum reclaimed water quality class	Crop category (*)	Irrigation method
A	All food crops consumed raw where the edible part is in direct contact with reclaimed water and root crops consumed raw	All irrigation methods
B	Food crops consumed raw where the edible part is produced above ground and is not in direct contact with reclaimed water, processed food crops and non-food crops including crops used to feed milk- or meat-producing animals	All irrigation methods
C	Food crops consumed raw where the edible part is produced above ground and is not in direct contact with reclaimed water, processed food crops and non-food crops including crops used to feed milk- or meat-producing animals	Drip irrigation (**) or other irrigation method that avoids direct contact with the edible part of the crop
D	Industrial, energy and seeded crops	All irrigation methods (***)

(\*) If the same type of irrigated crop falls under multiple categories of Table 1, the requirements of the most stringent category shall apply.

(\*\*) Drip irrigation (also called trickle irrigation) is a micro-irrigation system capable of delivering water drops or tiny streams to the plants and involves dripping water onto the soil or directly under its surface at very low rates (2–20 litres/hour) from a system of small-diameter plastic pipes fitted with outlets called emitters or drippers.

(\*\*\*) In the case of irrigation methods which imitate rain, special attention should be paid to the protection of the health of workers or bystanders. For this purpose, appropriate preventive measures shall be applied.

<sup>8</sup> Regulation (EU) 2020/741 of the European Parliament and of the Council of 25 May 2020 on minimum requirements for water reuse. Official Journal of the European Union 5.6.2020. L 177/32 <https://eur-lex.europa.eu/legal-content/EN/TXT/PDF/?uri=CELEX:32020R0741&from=EN>



Table 3: Reclaimed water quality requirements for agricultural irrigation (Regulation (EU) 2020/741).

Reclaimed water quality class	Indicative technology target	Quality requirements				
		E. coli (number/100 ml)	BOD <sub>5</sub> (mg/l)	TSS (mg/l)	Turbidity (NTU)	Other
A	Secondary treatment, filtration, and disinfection	≤ 10	≤ 10	≤ 10	≤ 5	Legionella spp.: < 1 000 cfu/l where there is a risk of aerosolisation Intestinal nematodes (helminth eggs): ≤ 1 egg/l for irrigation of pastures or forage
B	Secondary treatment, and disinfection	≤ 100	In accordance with Directive 91/271/EEC (Annex I, Table 1)	In accordance with Directive 91/271/EEC (Annex I, Table 1)	-	
C	Secondary treatment, and disinfection	≤ 1 000			-	
D	Secondary treatment, and disinfection	≤ 10 000	-			

(In accordance with Directive 91/271/EEC (Annex I, Table 1): BOD<sub>5</sub>: 25 mg/l; TSS: 35 mg/l).

(In accordance with the Urban Wastewater Treatment Directive 91/271/EEC (Annex I, Table 1): BOD<sub>5</sub> = 25 mg/l; TSS = 35 mg/l).

## 2. What is greywater?

Greywater is defined as “wastewater without any input from toilets, i.e. without urine, faeces and toilet paper, which means that it corresponds to wastewater produced in bathtubs, showers, hand washbasins, laundry machines and kitchen sinks, in households, office buildings, schools, etc.”<sup>9</sup>.

Greywater is usually characterised according to its source of origin and thus on basis of its degree of pollution:

- Light or low-strength greywater (low load) usually originates from showers, bathtubs and hand washbasins which are usually low polluted, whereas
- Dark greywater or high-strength (high load) greywater originates from more polluted sources such as greywater from kitchen sinks and laundry.

The degree of pollution and amount of greywater produced depends largely on user behaviour and the greywater source. Compared to toilet wastewater (blackwater), greywater is poor in nutrients (phosphorus and nitrogen), which are usually lower in greywater than in the effluent of many municipal wastewater treatment plants. The same applies to the microbial load, which is lower in greywater than blackwater. However, greywater is never free of microorganisms and greywater from showers and bathtubs may contain significant concentrations of bacteria of faecal origin.

Therefore, an appropriate and effective treatment of the greywater is indispensable to exclude any hygienic risks from greywater reuse, avoid odours and other nuisances and to achieve a high treated water quality for non-potable uses. Collecting greywater at the source and treating it separately, before it is mixed with other wastewater streams such as blackwater, leads to a more efficient use of this alternative water source.

### 2.1. Greywater reuse guidelines and regulations

The objective of establishing regulations for domestic recycled water is to ensure that the operation of water recycling systems is protective of public health and the environment. These guidelines usually include quality and technical requirements and can act as a target-setting tool for manufacturers of greywater recycling systems.

Most countries around the world do not have greywater regulations. Some countries like Germany, the UK and Canada have guidelines or recommendations set up by local authorities and professional bodies offering guidance to the implementation and operation of greywater systems and greywater quality requirements, dependent on the intended use (fbr<sup>10</sup>; BSI British Standards<sup>11,12</sup>; Health Cana-

9 Eriksson, E., Auffarth, K., Henze, M. and Ledin, A. (2002) Characteristics of grey wastewater. Urban Water, 4(1), 85

10 fbr Hinweisblatt H 202 (2017) Hinweise zur Auslegung von Anlagen zur Behandlung und Nutzung von Grauwasser und Grauwasserteilströmen. Association for Rainwater Harvesting and Water Utilisation (fbr) (identical to DWA-M 277E)

11 BSI (2010) Greywater Systems - Part 1: Code of Practice. BS8525-1:2010 BS Press

12 BSI (2011) Greywater Systems - Part 2: Domestic greywater treatment, requirements and methods. BS 8525-2:2011. BS Press



## Thematic Catalogue 2 - PART 2

da<sup>13</sup>). In the U.S., there are no national guidelines governing greywater reuse. The regulatory burden rests with the individual states, resulting in different standards among states that have developed criteria for greywater reuse. Only about 30 out of 50 states have regulations allowing, prohibiting or regulating greywater reuse in one form or the other<sup>14</sup>.

Although Australia is considered a leader with respect to greywater policies, so far there is no Australian national standard for greywater reuse. Instead, States and Territories each have their own legislation for greywater collection, treatment and reuse. The Australian Guidelines for water recycling also provide guidance to dealing with greywater recycling safely and sustainably<sup>15</sup>.

The Canadian Guidelines for Domestic Reclaimed Water for Use in Toilet and Urinal Flushing have been developed as a national approach for the safe and sustainable use of domestic reclaimed water (Health Canada, 2010).

In Germany, there are no mandatory regulations for greywater recycling. However, the EU Directive for Bathing Water has been taken as a basis to regulate the hygienic quality requirements for service water used for non-potable applications in buildings (2006/7/EC)<sup>16</sup>.

Table 4 Quality requirements for service water use in buildings based on the EU Directive for Bathing Water (Directive 2006/7/E)<sup>17</sup>. These quality requirements contain criteria based on organic, solids and microbial content in the service water.

Adequate treatment of the greywater prior to its reuse is essential to reduce the risks of pathogen transmission and to improve the efficacy of subsequent disinfection. Both treatment and disinfection of greywater are indispensable to provide water that is both safe and aesthetically appropriate for reuse.

(\*Service water” is used synonymously with recycled or reclaimed water).

Table 4: Quality requirements for service water use in buildings based on the EU Directive for Bathing Water (Directive 2006/7/E).

Quality Target	Guide Value
Nearly free from suspended material, nearly odourless, colourless and clear	Turbidity < 2 NTU
Oxygen-rich	> 50% Saturation
Transmission (254nm) (1 cm)	> 60%
Low BOD	BOD <sub>7</sub> < 5 mg/l
Hygienically/microbiologically safe	Total coliforms < 10,000/100 ml
	E. coli < 1,000/100 ml
	Pseudomonas aeruginosa < 100/100 ml

13 Health Canada (2010) Canadian Guidelines for Domestic Reclaimed Water for Use in Toilet and Urinal Flushing. Ottawa, Ontario. January 2010

14 Sheikh, B. (2010) White paper on graywater. Report sponsored by the American Water Works association, Water Environment Federation and the Water Reuse Association

15 Australian Guidelines for Water Recycling: Managing Health and Environmental Risks (2006) National Water Quality Management Strategy

16 EU Directive for Bathing Water (2006) Directive 2006/7/EC of the European Parliament and of the Council of 15 February 2006 concerning the management of bathing water quality and repealing Directive 76/160/EEC. Jo L 64, 4.3.2006. <http://eur-lex.europa.eu/LexUriServ/LexUriServ.do?uri=OJ:L:2006:064:0037:0051:EN:PDF>

17 Berlin Senate Department for Urban Development (2007) Innovative water concepts: service water utilisation in buildings. Ecological urban Planning. Department VI, Ministerial Building Affairs. Berlin Senate Department for Urban Development [https://www.stadtentwicklung.berlin.de/bauen/oekologisches\\_bauen/de/download/index.shtml](https://www.stadtentwicklung.berlin.de/bauen/oekologisches_bauen/de/download/index.shtml)



The fbr- Information Sheet H 202 (fbr, 2017) and DWA-M 277E<sup>18</sup> give comprehensive technical information on the planning, design, operation and maintenance of greywater recycling systems in buildings.

The European standard pr EN 16941-2:2017, dealing with systems for the use of treated greywater, is currently under approval by the European Committee for Standardisation (CEN)<sup>19</sup>. The standard specifies the principles of design, sizing, installation and maintenance of greywater systems with the purpose of onsite use of the treated greywater for toilet flushing, gardening, laundry and for cleaning purposes. This document also specifies the minimum requirements for greywater treatment systems.

## 2.2. Greywater characteristics and composition

Greywater constitutes the largest proportion of wastewater by volume produced in an average household, accounting to between 50 and 75% of the total wastewater flow, and over 90%, if vacuum toilets are employed. Typical volumes of greywater vary from 60 to 120 l/p/d depending on living standards, user behaviour, population structure, customs and habits, water installations and water availability. These values can drop to 20 - 30 l/p/d in low-income countries with water shortage and elementary water supply<sup>20</sup>. With greywater recycling, the drinking water demand can be easily reduced to 45 l/p/d (fbr, 2017).

Depending on the available greywater sources and the required reuse applications for greywater, different recycling potentials can be achieved which vary between 30 and 80% (Figure 1).

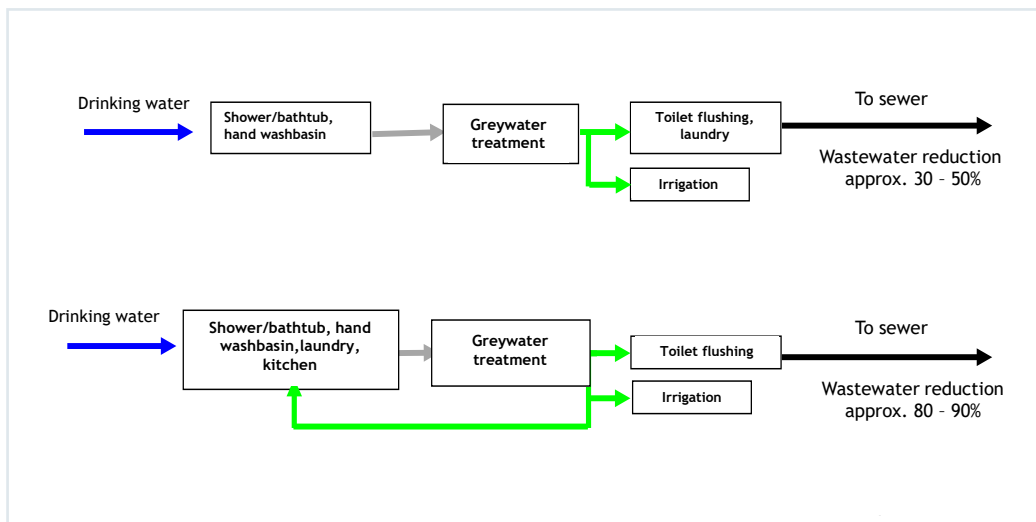

Figure 1: The potential wastewater reduction in a single household

18 Guideline DWA-M 277E (2017) Information on design of systems for the treatment and reuse of greywater and greywater partial flows. DWA Set of Rules, German Association for Water, Wastewater and Waste (DWA), Hennef. October 2017

19 pr EN 16941-2:2017 (2017) On-site non-potable water systems - Part 2: Systems for the use of treated greywater. The European Committee for Standardisation (CEN). German and English version prEN 16941-2:2017 (Draft version)

20 Morel, A. and Diener, S. (2006) Greywater management in low and middle-income countries. Water and Sanitation in Developing Countries (Sandec). Eawag: Swiss Federal Institute of Aquatic Science and Technology <https://www.susana.org/en/knowledge-hub/resources-and-publications/library/details/947>



## Thematic Catalogue 2 - PART 2

depending on inclusion of different greywater sources for recycling.

Figure 2 shows the average amounts of partial water flows generated from different activities in private households (litres per person and day) and the greywater recycling potential<sup>21</sup>.

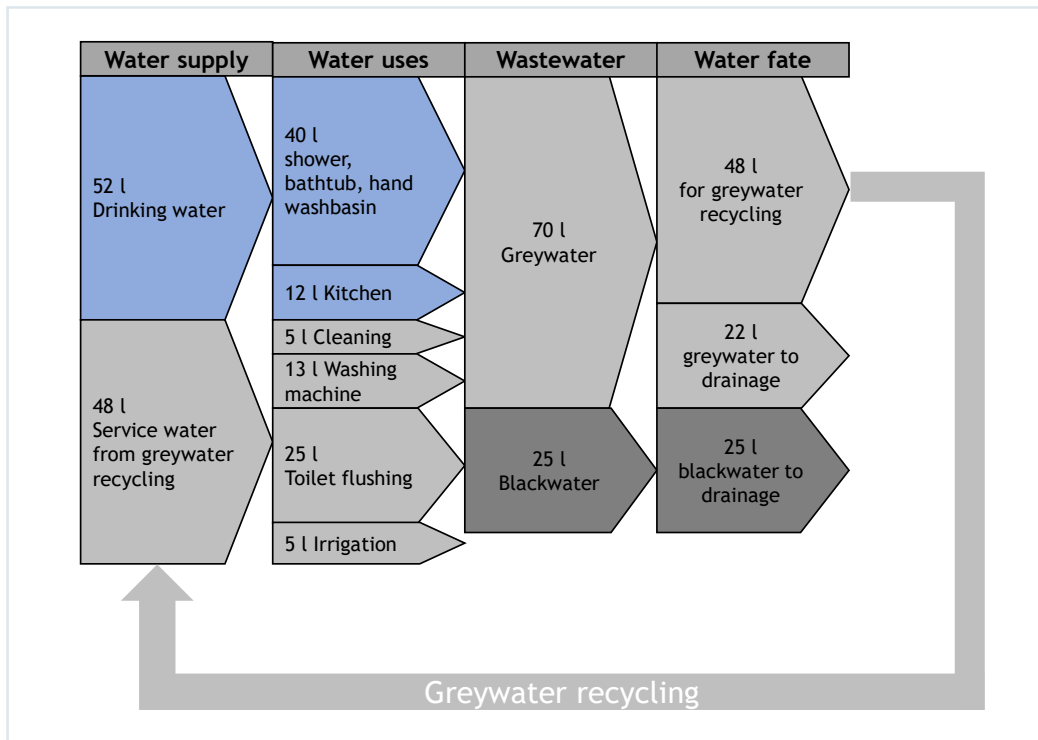
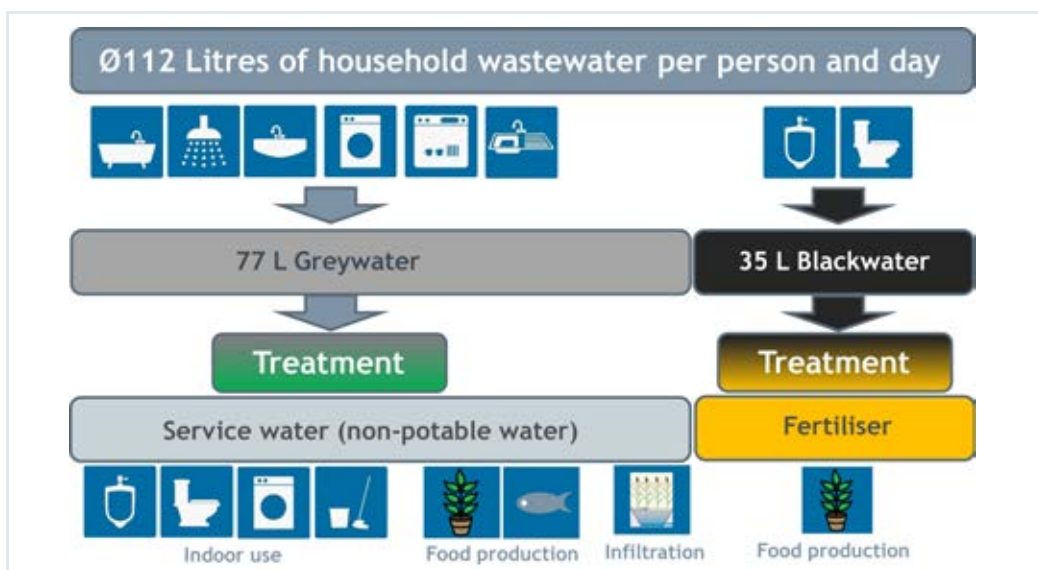

Figure 2: Average partial water flows (l/p/d) in private households in new and renovated buildings (Adapted from Mehlhart, 2001).

Figure 3 shows the sources and average amounts of greywater and of blackwater produced daily in an average German household. The average amount of generated greywater of 77 l can be treated and reused for different non-potable applications including toilet flushing, laundry, irrigation and cleaning.



21 Mehlhart, G. (2001) Grauwasser auf dem Vormarsch. fbr Wasserspiegel 2/200, Seiten 14-16



Figure 3: Sources and volumes of household wastewater in an average German household (E. Nolde).

Greywater also varies greatly in quality and quantity depending on the type of building (single family, multi-storey), user habits, use of chemicals in households for washing, cleaning and laundry (fats, oils, soap residues, detergents, etc.), connected appliances and the greywater source. Compared to blackwater, greywater usually exhibits only half of the organic pollution load, but it could be higher, if water-saving measures and devices are applied in households<sup>22</sup>.

The quality and quantity of generated greywater are not constant throughout the day but show a wide variability depending on the household activities and the number of persons in household. For example, showering and shaving may take place in the morning, frequent hand washing and toilet flushing during the day, bathing and skin care in the evening. Figure 4 demonstrates water use patterns and user habits as well as the daily averages of water flows over a 4-week period (working days and weekends) in a multi-storey building (45 residents) treating greywater from showers and bathtubs for toilet flushing.

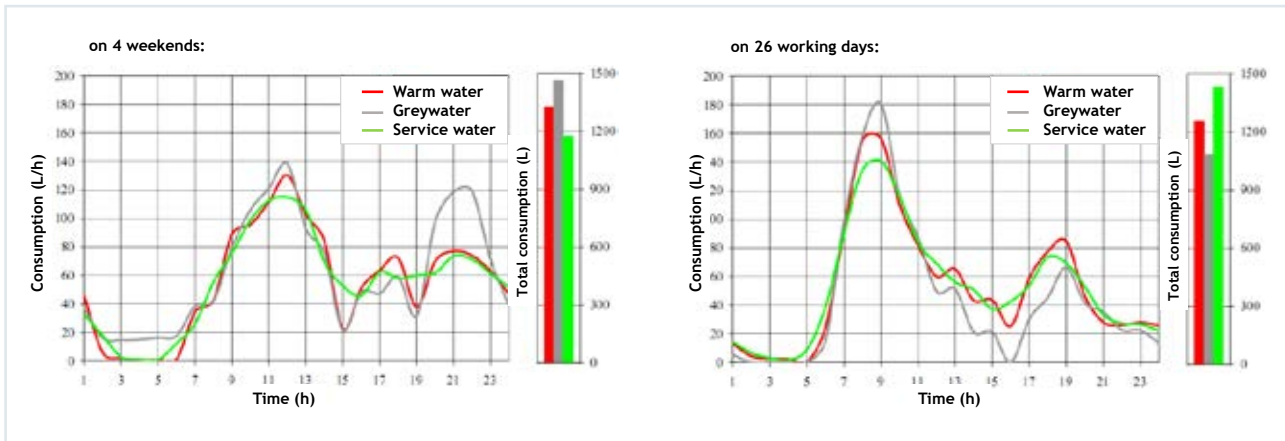

Figure 4: Average daily water flows and use patterns over a period of 4 weeks in a multi-storey building applying greywater recycling. Greywater originates from showers and bathtubs (45 persons) and is reused for toilet flushing following treatment (E. Nolde).

### 2.2.1. Organic pollution

Greywater varies significantly in composition and a wide range for organic loads and nutrients have been published in the literature. Greywater from kitchen sinks, dishwashers or washing machines usually contains a higher organic load compared to greywater from showers, bathtubs and hand washbasins. Greywater from laundry usually contains more salts, while that from kitchen more oil and grease.

Greywater typically contains high concentrations of easily biodegradable organic material, such as fat and oil from cooking, food residues, residues from soaps, detergents and other cleaning household products. Kitchen sink and dishwasher greywater may contribute to 40 - 60% of the major organic pollutant load in greywater.

The organic greywater load, usually measured as Biochemical Oxygen Demand (BOD) or Chemical Oxygen Demand (COD) is a measure of the degree of pollution and it could be even higher than that

22 Otterpohl, R., Braun, U. and Oldenburg, M. (2003) Innovative technologies for decentralised water, wastewater and biowaste management in urban and peri-urban areas. *Water Science & Technology* 48 (11/12): 23-32



of blackwater, when water-saving measures and devices are applied in household.

Table 5 shows the blackwater and greywater volumes generated in a household (litres per person and day) and the percentages of organic and nutrient contents in the two wastewater streams. Compared to blackwater, greywater contains far less nitrogen, phosphorus and potassium, three basic nutrients required for plant growth and soil fertility.

Table 5: Volumes and daily loads of organic matter and nutrients in greywater and blackwater.

	Total wastewater stream (daily load)	Blackwater	Greywater
		Faeces + Urine + 30 litres toilet flush water	
<b>Volume</b>	112 l/p/d	31.3%	<b>68.7%</b>
<b>COD</b>	117 g/p/d	59.8%	40.2%
<b>N</b>	12.9 g/p/d	<b>92.2%</b>	7.8%
<b>P</b>	2.0 g/p/d	<b>75.0%</b>	25.0%
<b>K</b>	4.2 g/p/d	<b>76.2%</b>	23.8%
<b>S</b>	3.8 g/p/d	23.7%	<b>76.3%</b>

Table 6 and Table 7 show variations in the volumes and loads of different greywater parameters in a European survey based on greywater data from different countries<sup>23,24</sup>. 60% of the data are from Germany, 20% from Sweden, 10% from the Netherlands and the remaining from other countries. 45 % of the references dealt with light greywater.

Table 6: Variations in volume and pollution load (per person per day) in greywater for different parameters based on a European survey on greywater (Sievers et al., 2014; Sievers & Londong, 2018).

Parameter	n	Unit	Mean	STD	Median	Range
Volume	43	l/(c*d)	82	23	74	33 - 150
TSS	25	g/(c*d)	26	24	13	1 - 71
BOD <sub>5</sub>	28	g/(c*d)	17	6	18	4 - 27
COD	40	g/(c*d)	40	14	41	9 - 71
TP	41	g/(c*d)	0.5	0.2	0.5	0.1 - 0.8
TN	40	g/(c*d)	1.1	0.5	0.9	0.4 - 2.9
NH <sub>4</sub> -N	11	g/(c*d)	0.2	0.2	0.2	0.1 - 0.7

23 Sievers, J. and Londong, J. (2018) Characterization of domestic greywater and greywater-solids. Water Science & Technology 77 (5): 1196-1203

24 Sievers, J., Oldenburg, M., Albold, A. and Londong, J. (2014) Characterization of greywater - estimation of design values. IFAT 2014. EWA 17th International Symposium, 07.05.2014



Table 7: Variations in the concentrations of different greywater parameters based on a European survey (Sievers et al., 2014; Sievers & Londong, 2018).

Parameter	n	Unit	Mean	STD	Median	Range
TSS	16	mg/l	158	154	92	23 - 570
BOD <sub>5</sub>	30	mg/l	228	96	217	56 - 427
COD	47	mg/l	501	231	490	102 - 1581
TP	42	mg/l	6	4	5	0.5 - 15
TN	42	mg/l	17	10	13	17593
NH <sub>4</sub> -N	27	mg/l	5.7	5.4	3.7	0.5 - 25

All types of greywater, including kitchen and laundry water, have shown good biodegradability in practice, which is an indication that greywater can be treated for reuse. The COD/BOD<sub>5</sub> ratio, which is a measure of the biodegradability, is usually higher than that in blackwater, ranging between 2 and 3.6, and being higher in light greywater indicating that the organic matter in this greywater stream is less biodegradable<sup>25</sup>.

### 2.2.2. Nutrients in greywater

The nutrient content of greywater is generally low compared to normal sewage. In some cases, there can be high concentrations of phosphorus, but the levels of nitrogen are always low. Phosphorous originates mainly from washing and dishwashing powder, where it is used for water softening. If only phosphorus-free detergents are used in household, the phosphorus content could be reduced to levels lower than normally found in treated wastewater effluents.

Greywater contributes to 10 - 30% of the total phosphorus input into a combined wastewater system and the concentrations are mainly governed by the type of used detergents. Greywater also contributes to less than 10% of the total nitrogen content in wastewater and the nitrogen concentration in greywater is often less than 10 mg/l prior to treatment<sup>26</sup>.

In spite of the low N and P concentrations in greywater, many studies have shown that these low concentrations are not limiting to bacterial growth and therefore, will not inhibit the biological treatment process of greywater.

### 2.2.3. Pathogens in greywater

The presence of potential pathogens in greywater is mainly a result of its contamination with faeces from showering, bathing or washing of diapers. However, greywater usually contains less faecal contamination than blackwater usually in the range of 10<sup>1</sup> - 10<sup>2</sup> (fbr, 2017).

25 Jefferson, B., Palmer, A., Jeffrey, P., Stuetz, R. and Judd, S. (2004) Grey water characterisation and its impact on the selection and operation of technologies for urban reuse. *Water Science and Technology*, 50 (2): 157-164

26 Vinnerås, B., Palmquist, H., Balmér, P. and Jönsson, H. (2006) The characteristics of household wastewater and biodegradable solid waste - A proposal for new Swedish design values. *Urban Water Journal* 3 (1): 3-11





As greywater does not contain faeces, it is normally regarded as rather harmless. Therefore, the main risk of infection is a function of the faecal contamination of the greywater, which can never be ruled out.

The detection of faecal indicator bacteria in greywater, such as the faecal coliform group and more specifically *E. coli* spp., which are normally found in faeces without causing any illness, demonstrates the potential presence of faecally transmitted pathogens such as *Salmonella* or enteric viruses<sup>27,28</sup>. The average concentrations of indicator bacteria in greywater are similar to those in secondary treated wastewater effluents. Faecal coliforms, *E. coli* or enterococci are commonly reported in greywater, demonstrating that faecal contamination of greywater is not an occasional occurrence but is to be expected.

The occurrence of high numbers of faecal indicator bacteria in greywater can be due to the presence of easily biodegradable organic compounds and the prevailing higher temperatures, making greywater an ideal medium for microbial growth<sup>29</sup>. However, the focus on faecal indicator bacterial in greywater may lead to an overestimation of the faecal loads and, therefore, the hygienic risk. In this case, care is needed in interpreting data due to the possibility of bacterial regrowth that may result in overestimation of the microbial risk.

## 2.3. Requirements for greywater recycling

### 2.3.1. Quality requirements

In general, recycled greywater should fulfil four criteria for reuse<sup>30</sup>:

- Hygienic safety
- Aesthetics (no comfort loss or nuisance to user)
- Environmental tolerance, and
- Economic feasibility.

The different reuse applications for greywater require different water quality requirements and thus different treatment levels and technologies, varying from simple processes to more advanced ones. The physico-chemical and microbiological requirements listed in Table 4 ensure a high and hygienically safe service water quality, if they are fully adhered to. They also guarantee a long-time storage of the service water without any odours or comfort loss to users and provide water which is nearly free from any colouration and/or suspended solids, which is highly suitable for non-potable uses.

In addition to hygienic safety, environmental tolerance of the selected technology should be also considered when planning a greywater recycling system, such as a low specific energy demand for

27 Winward, G.P., Avery, L.M., Frazer-Williams, R., Pidou, M., Jeffrey, P., Stephenson, T., Jefferson, B. (2008a) A study of the microbial quality of grey water and an evaluation of treatment technologies for reuse. *Ecological engineering* 32: 187-197

28 Ottoson, J. and Stenström, T.A. (2003) Faecal contamination of greywater and associated microbial risks. *Water Research* 37 (3): 645-655

29 Lazarova, V., Hills S. and Birks R. (2003) Using recycled water for non-potable, urban uses. A review with particular reference to toilet flushing. *Water Science & Technology* 3 (4): 69-77

30 Nolde, E. (2005) Greywater recycling systems in Germany - results, experiences and guidelines. *Water Science & Technology* 51 (10): 203-210



greywater treatment ( $< 1.5 \text{ kWh/m}^3$ ), no use of chemicals and UV disinfection instead of chlorination as a final treatment stage.

The treatment technology for greywater should be economically feasible and should pay off within a reasonable amortisation period. Costs should not overly exceed those of the conventional wastewater treatment system. Lower operating costs can be achieved, if high-quality system components are installed, which require low maintenance and energy consumption.

## 2.3.2. Technical requirements

### 2.3.2.1. Dual-pipe system

When considering greywater recycling in a new building or during renovations, a dual-pipe plumbing system should be installed for the separate collection of the two major wastewater flows: blackwater (from toilets) and greywater. Greywater from connected sources (e.g. showers, bathtubs, washing machines, kitchen sink) flows directly through the greywater pipe network into the greywater recycling system. Also, a separate pipe network system for the distribution of the service water to the different points of use should be installed (Figure 5). To carry out network separation, reference is made to DIN EN 1717<sup>31</sup>.

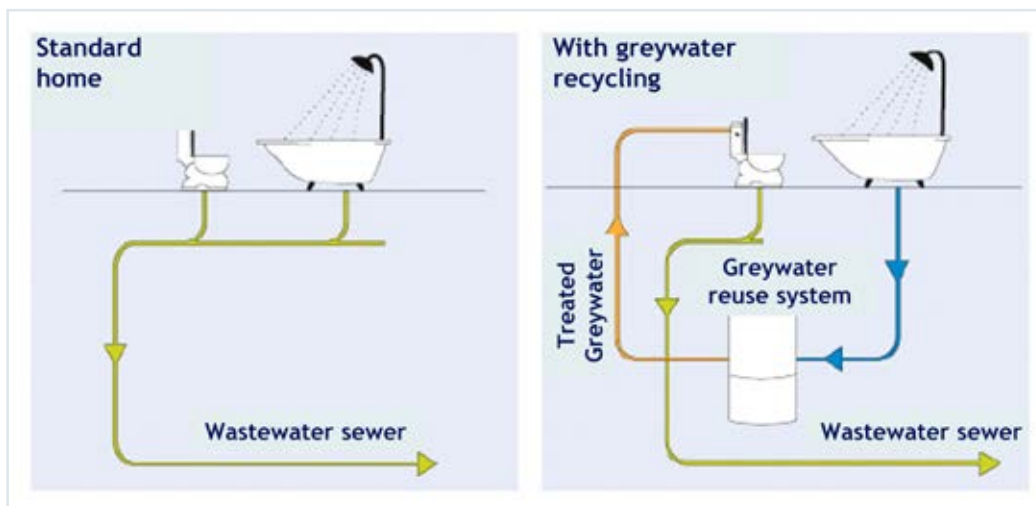

Figure 5: A simplified diagram of a single and dual-pipe system in a household.

During construction it should be guaranteed that there are no cross-connections between the service water and the drinking water supply networks. All pipework and fittings should be properly marked and labelled. As a rule, the different pipe networks should have different colours and the service water tapping points should be properly labelled to distinguish them from drinking water installations. It must also be secured that no greywater from the greywater reuse system enters the drinking water network at any point. Cross connections should be checked prior to commissioning of the greywater system (for example, using the dye test).

Greywater systems should also have an overflow connection to the sewer allowing collected water to flow directly to the sewer during periods of maintenance or system breakdown. A backflow prevention arrangement which hinders the reversal flow of non-potable water into the drinking water network should also be provided for.

<sup>31</sup> DIN EN 1717:2011-08 (2011) Protection against pollution of potable water installations and general requirements of devices to prevent pollution by backflow; German version EN 1717:2000; Technical rule of the DVGW. Beuth Publications



### 2.3.2.2. Backup water supply

Greywater reuse systems must be provided with an automatic backup water system to ensure continuous supply of service water (free outlet) (Figure 6). Drinking water, rainwater or other water sources of suitable quality can be used.

A float switch located inside the storage tank activates the backup water supply, when the water level in the storage tank reaches a low level. The float switch turns off the backup water supply at a pre-set level to leave space for incoming recycled water. For the installation of a backup water system, reference is made to DIN 1989-1:2002-04<sup>32</sup> and DIN EN 1717:2011-08 (2011).

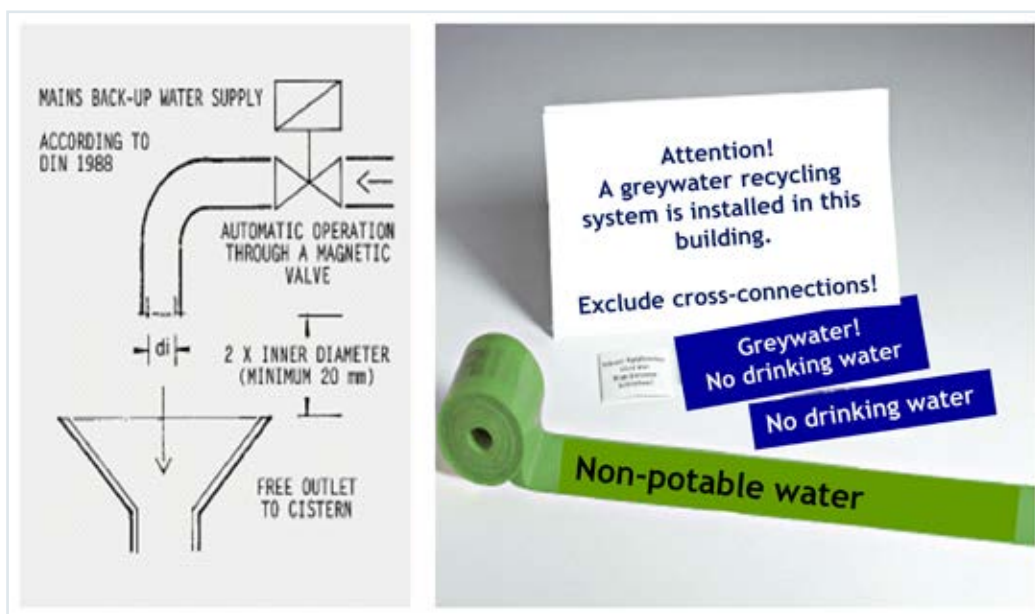

Figure 6: A diagram showing the backup water supply (left) and materials used to label pipework and tapping points of the service water network (right).

### 2.3.2.3. Pumps

Pumps should be corrosion resistant and able to pump to the required head to fill the storage tank or supply adequate flow, if pumped directly to the point of use. Submersible pumps and external self-priming pumps are typically used and low-energy, low-noise and robust pumps should be preferred. Pumps should be sized such that each pump is capable of overcoming static lift plus friction losses in the pipework and valves. The pump control unit should operate the pump to match demand, protect the pumps from running dry, protect the motor from over-heating and electric overload and permit manual override. Pumps should be placed in a well-ventilated location and protected from extremes of temperature, with sound-free and vibration-free mountings.

<sup>32</sup> DIN 1989-1:2002-04 (2002) Rainwater harvesting systems - Part 1: Planning, installation, operation and maintenance. Beuth publications.



#### 2.3.2.4. Control panel

A control panel should indicate:

- System is operating correctly
- Alarms indicating failure of system components (e.g. pump, level control, UV disinfection)
- Levels in all tanks
- Power supply status
- Water flows
- Operating hours (records of on/off cycles combined with flows)
- Automatic control of backup water supply to meet variations in supply and demand
- Water quality parameters that can be detected on a continuous basis (pH, T °C, turbidity, DO, etc.)
- Online monitoring results to control the quality of treated greywater.

#### 2.3.3. Installation requirements

Installation of greywater recycling systems should be conducted by licensed and qualified persons/plumbers.

For installations in a building, the following preliminary data is required on:

- Dimensions of the installation room
- Smallest clearance dimension (doors)
- Load-bearing capacity of the ground
- Other influencing factors such as increased dust formation, increased room temperature, aeration and ventilation.

For installations in the ground, the following data is required on:

- Built volume
- Soil conditions
- Groundwater table
- Distance to the building.

The needed space requirement of about 0.1 m<sup>2</sup> per person is representative for biological systems used for greywater treatment. This is primarily dependent on the greywater pollution load, needed buffer storage volume for greywater and service water peak flows as well as on the local service water quality requirements. Systems should be installed such that access to all system parts is possible at all times for maintenance.

#### 2.3.4. Operational requirements

For a proper system operation, certain criteria should be taken into consideration:

- System should be robust, insusceptible to fluctuations and system components long-lasting
- Energy input for the greywater recycling system should not exceed that for a conventional wastewater treatment system. This should be possibly less than 1.5 kWh for treatment including the distribution of one cubic metre of service water
- Low operation and low maintenance expenditure
- The use of chemicals for treatment, operation and maintenance should be avoided.



### 2.3.5. Maintenance requirements

These may include:

- Automatic and periodic cleaning of sieves/filters
- If high-load greywater flows (e.g. from kitchen and washing machines) are also included in the greywater stream, the maintenance expenditure is expected to be slightly higher than when only low-load greywater is treated
- Easy access to system components (tanks, pumps, filters, etc.) to ensure safe and efficient operation
- An internet-based monitoring unit helps optimise system operation and reduce costs for maintenance and operation.

## 2.4. Applications for recycled greywater

The most common application for recycled greywater (service water) is toilet/urinal flushing, which can alone reduce the water demand in a household up to 30% and exceed 60% in offices and commercial buildings. Greywater, once appropriately treated, is considered suitable for non-potable applications such as toilet flushing, laundry, cleaning, irrigation, car washing, fire protection, hydroponic culture, aquaculture, street cleaning and preservation of wetlands. The water quality requirements are site and application-specific and the level of treatment needed depends on the quality of the raw greywater as well as the intended reuse application, both equally affecting the choice of the treatment technology.

For agricultural use, the service water quality should be sufficient to protect human health when consuming raw food produced from irrigation with recycled greywater. In most cases, salinity is an important factor which requires close monitoring and control, when using treated greywater for irrigation. The World Health Organisation (WHO) published guidelines for the safe use of greywater in agriculture<sup>33</sup>.

The main use of recycled water in industry is for cooling purposes, either in closed or in open circuits. In closed circuits, there is no direct contact to humans or the environment, whereas in open circuits aerosols may be formed leading to risks related to the presence of *Legionella* spp. Correct management of this practice should also prevent corrosion and calcareous deposits to protect pipelines and vessels.

33 WHO (2006) WHO Guidelines for the safe use of wastewater, excreta and greywater. Volume 4. Excreta and greywater use in agriculture. 3rd Edition. World Health Organisation (WHO), Geneva, Switzerland.  
<https://www.who.int/publications/i/item/9241546859>



## 2.5. Benefits of greywater recycling

A number of benefits are associated with greywater reuse such as the onsite increase in sustainable water availability and contribution to climate change adaptation. These include:

- Reduced demand for potable water
- Reduced load on wastewater treatment plants or onsite treatment systems (e.g. septic tanks)
- Reduced energy requirements for the transport of water
- Reduced amounts of greenhouse gas emissions
- Reduced dependency on the public water supply
- Reduced water bills
- Conservation of water resources
- Reclaimed use of nutrients, which might otherwise be wasted, as a valuable resource for landscaping and plant growth
- Green building code certification.

## 2.6. Risks of greywater recycling

The risks of greywater recycling are minimal, if the valid technical rules and regulations for the installation and operation of greywater recycling systems are applied. With the appropriate treatment technology and system maintenance, a high service water quality can be guaranteed that will exclude any hygienic or environmental risks.



### 3. Greywater management and treatment

Greywater may contain high levels of easily biodegradable organic compounds, which can readily decompose and turn the medium anaerobic causing bad odours. Therefore, the primary treatment target is to reduce the level of organic pollutants found in greywater. A secondary target, is to reduce the levels of potential pathogens and other microorganisms that may be found in greywater.

The final quality of the treated greywater is important because of its impact on the reuse applications as well as on the disinfection process, which is usually applied as the final treatment stage. Also, the removal of suspended solids in greywater is important as particulate matter can shield microorganisms from disinfection<sup>34</sup>.

The choice of the treatment technology is mainly dependent on:

- Pollution level of the greywater (greywater sources used)
- Intended end use
- Required (local) quality requirements for service water.

Other factors which may also influence technology selection include the planned site, available space and investment and maintenance costs.

Today, the selection of a greywater treatment technology revolves around biological systems as the major treatment stage, since it is unlikely that merely physical processes such as coarse filtration or screening will provide treated greywater suitable for reuse.

A wide variety of technologies can be used for greywater treatment including physical, chemical and biological processes or a combination of them. Figure 7 proposes some recycling schemes for greywater treatment based on the characteristics of the influent greywater and the service water quality requirements for non-potable applications<sup>35</sup>. These technologies are well-established treatment methods, which are also commonly applied in the conventional wastewater treatment sector.

34 Winward, G.P., Avery, L.M., Stephenson, T. and B. Jefferson, B. (2008b) Ultraviolet (UV) disinfection of grey water: particle size effects. *Journal of Environmental Technology* 29 (2): 235-244.

35 Li, F., Wichmann, K. and Otterpohl, R. (2009) Review of the technological approaches for grey water treatment and reuses. *Science of the Total Environment* 407: 3439-3449.

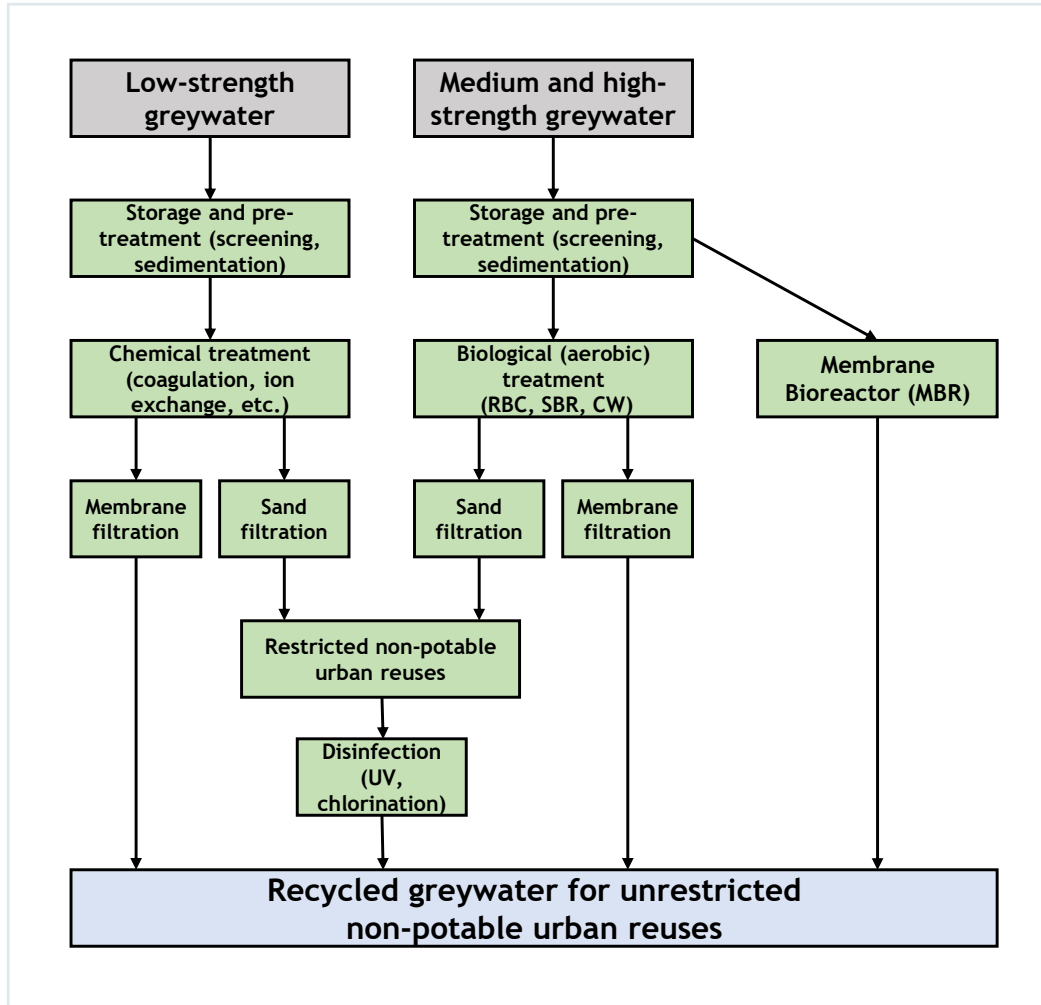

Figure 7: Greywater recycling schemes for non-potable urban reuses (Adapted from Li et al. 2009).

### 3.1. Greywater treatment technologies

Greywater treatment technologies must be robust and efficient in handling variations in organic and microbial loads in greywater and consistently produce a treated effluent of high and safe quality to meet required standards for reuse. Systems ranging from low-tech, simple filtration systems up to high-tech, multi-barrier systems including biological treatment, membrane filtration and UV disinfection are considered most appropriate for the treatment of greywater due to their efficient removal of organic compounds<sup>36</sup>.

Generally, treatment of household greywater requires a combination of physical and biological treatment processes for the removal of particulate and dissolved organic matter. Chemical processes such as coagulation, ion exchange, photo-catalytic oxidation and granular activated carbon are usually indicated for low-strength greywater. However, these processes are also associated with high energy and material consumption as well as production of waste by-products and are generally not recommended for greywater recycling.

36 Pidou, M., Memon, F.A., Stephenson, T. Jefferson, B. and Jeffrey, P. (2007) Greywater recycling: treatment options and applications. *Engineering Sustainability* 160 (3): 119-131.





## Thematic Catalogue 2 - PART 2

Greywater systems typically comprise the following components (Figure 8):

- A pre-sedimentation/buffering tank to collect the greywater
- A treatment system (biological)
- A post-sedimentation tank
- A storage tank for the treated greywater
- A disinfection system
- A backup supply system
- A booster pump to supply water to the points of use.

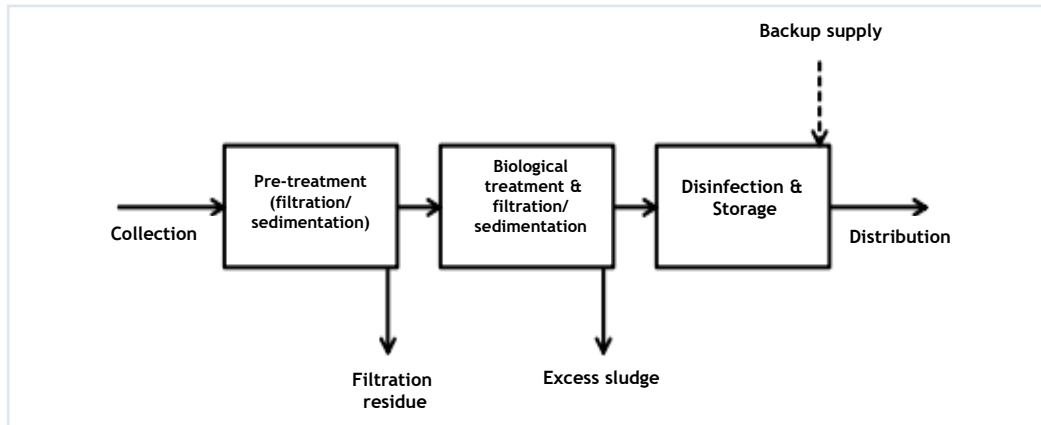

Figure 8: A simple schematic diagram of a greywater recycling system.

Several aerobic, biological treatment systems, which are commonly used in the conventional wastewater treatment sector, can be successfully applied for greywater treatment including Rotating Biological Contactors (RBC), Sequencing Batch Reactor (SBR), Moving Bed Biofilm Reactor (MBBR), Membrane Bioreactors (MBR) and constructed wetlands. Biological systems are usually preceded by a coarse filtration stage (pre-treatment) and the biologically treated effluent by a sedimentation/filtration stage (post-treatment) to remove the sludge. A final disinfection stage to remove microorganisms is indispensable. Aerobic biological processes are able to achieve very good organic and turbidity removal rates allowing storage of the treated greywater over longer periods.

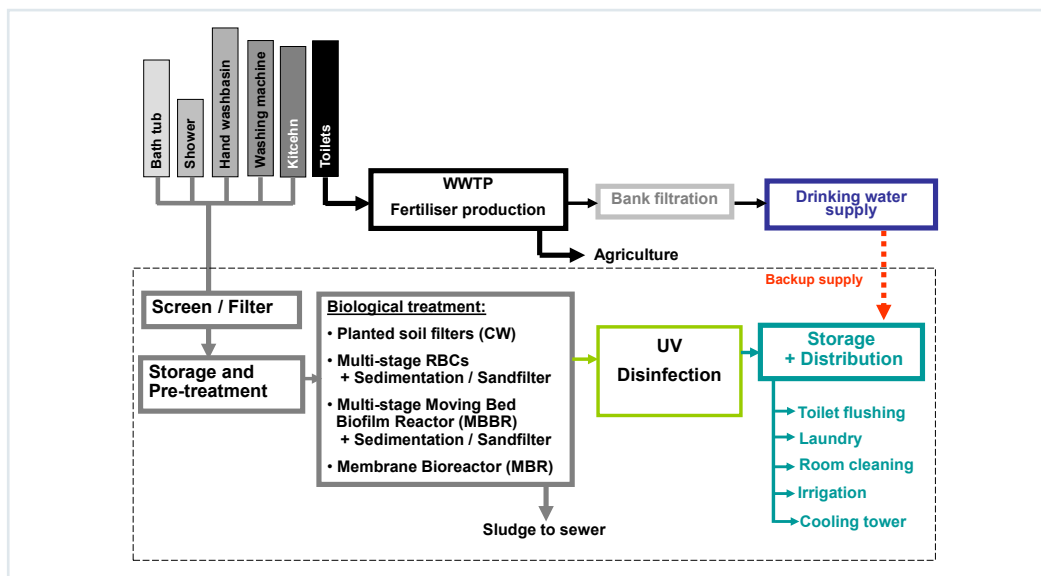

Figure 9: Schematic diagram of greywater recycling options for different greywater sources (E.Nolde).



## Thematic Catalogue 2 - PART 2

A pre-treatment stage using self-cleaning sieves or filters is usually incorporated in all systems to remove coarse material (hair, lint, sand and other particulate matter). If kitchen greywater is included in the wastewater stream, it is recommended to install a combined oil/grease and sediment trap.

Since the generation of greywater in households is intermittent, a buffered collection storage tank is usually required to provide a relatively uniform influent flow throughout the treatment process.

Figure 10 shows a schematic diagram of a greywater recycling system in a multi-storey building, where service water is used for toilet flushing and/or irrigation/infiltration. The connection of the washing machine to the service water network to use service water for laundry instead of drinking water remains optional.

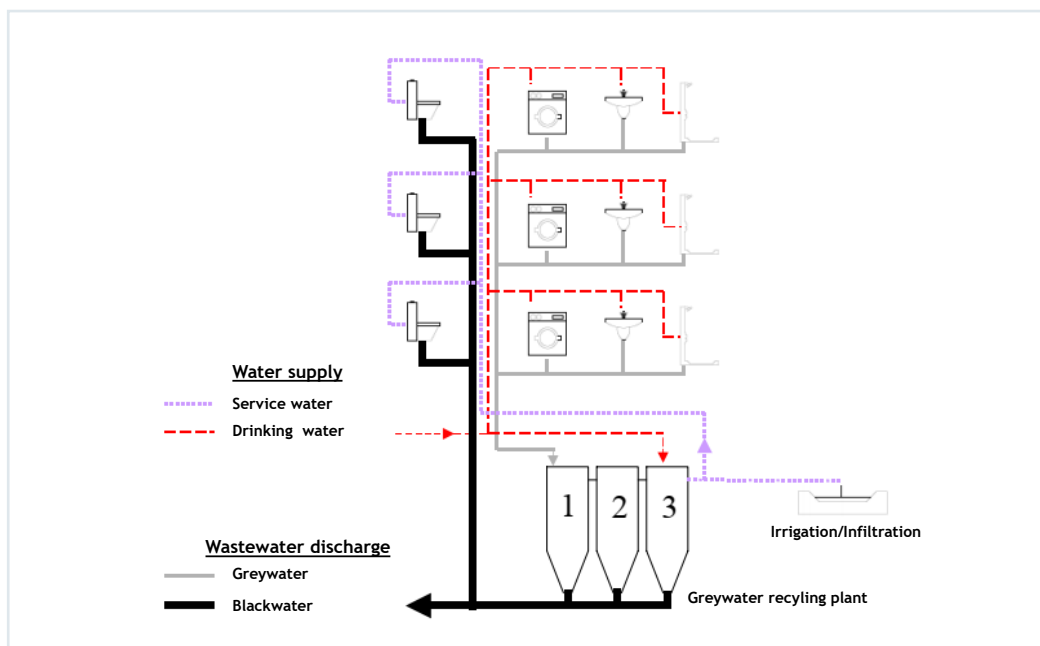

Figure 10: A schematic diagram of a greywater recycling system for multi-storey buildings:  
1. Collection, buffer and sedimentation; 2. Biological treatment; 3. Storage and supply (fbr)

### 3.1.1. Physical treatment (Pre-treatment)

Pre-treatment of the greywater is necessary to remove suspended solids (SS), grease and fat as well as coarse material, which may clog the system or create bad odours. Physical greywater treatment methods include filtration and sedimentation (solid-liquid separation). The efficiency of the filtration techniques depends on the particle size of the greywater pollutants and filter porosity. Filtration is usually used as a pre-treatment and/or post-treatment method (e.g. prior to disinfection). Filtration techniques include sieves and filters, sand filtration, gravel filtration and membrane filtration (MF, UF). The use of physical processes as the sole treatment method, except for membrane filtration, is not sufficient to treat greywater, since it does not ensure adequate reduction of organics, nutrients and other pollutants, except in situations where the organic strength of the greywater is extremely low.

Membrane filtration such as microfiltration (MF), ultrafiltration (UF) and nanofiltration (NF) produce a high-quality greywater effluent. The permeate obtained with NF membranes is of highest quality, as they remove soluble organic matter, ionic compounds, pathogens and even viruses. However, higher energy consumption and membrane clogging and fouling are connected with these systems, thus limiting their economic viability.



Sand filtration is a simple and cost-effective technology, but provides a limited treatment option for greywater when applied alone. However, sand filtration is highly effective when used as a polishing stage of the final effluent product prior to UV disinfection.

### 3.1.2. Chemical treatment

Chemical greywater treatment systems include coagulation and flocculation, electrocoagulation, adsorption using granular activated carbon (GAC) and natural zeolites, magnetic ion exchange resin (MIEX), powdered activated carbon (PAC) and advanced oxidation processes (AOPs) such as ozonation, and photocatalysis. These methods are usually followed by filtration and/or disinfection. These systems are efficient for use with light greywater and, in some cases, laundry greywater. In comparison with the physical processes used for greywater treatment, chemical processes are able to reduce the organic load and turbidity in greywater to a certain extent, but are not sufficient to meet the non-potable water reuse standards, especially for high strength greywater<sup>37</sup>.

In general, the high energy and material demand for chemical treatment processes and the resulting waste by-products warrant their wide application on a large scale.

### 3.1.3. Biological Treatment

Biological systems for greywater vary in their treatment mechanisms, but the basic principle is the same as the biological systems applied for the secondary treatment of municipal wastewater. Bacteria are used in these systems to remove the major organic pollutants in greywater. Greywater is usually aerated to enhance bacterial growth and the decomposition of the organic matter. Some systems are entirely mechanical, while others are more nature-based such as constructed wetlands. The development of a biofilm in these systems can take different forms such as suspended biomass or a fixed biofilm. Biological processes based on suspended biomass (e.g. activated sludge process) are effective in removing organic carbon and nutrients. However, these systems show problems with sludge settleability and the need for large reactors and settling tanks and biomass recycling. Membrane bioreactors (MBRs), which are also based on the suspended biomass process are very effective in treating greywater to high standards<sup>38,39</sup>.

Systems based on the fixed biofilm process have proved to be more reliable in removing organic carbon and nutrients without the problems encountered in the activated sludge process. These include rotating biological contactors (RBC)<sup>40,41</sup>, sequencing batch reactors (SBR)<sup>42</sup> and moving bed biofilm

37 Pidou, M., Avery, L., Stephenson, T., Jeffrey, P., Parsons, S.A., Liu, S., Memon, F.A., Jefferson, B. (2008) Chemical solutions for greywater recycling. *Chemosphere* 71: 147-155.

38 Merz, C., Scheumann, R., Hamouri, B.E. and Kraume M. (2007) Membrane bioreactor technology for the treatment of greywater from a sports and leisure club. *Desalination* 215 (1-3): 37-43.

39 Fountoulakis, M.S., Markakis, Petousi, I. and Manios, T. (2016) Single house on-site grey water treatment using a submerged membrane bioreactor for toilet flushing. *Science of the Total Environment* 551-552: 706-711.

40 Nolde, E. (1999) Greywater reuse systems for toilet flushing in multi-storey buildings - over ten years' experience in Berlin. *Urban Water* 1: 275-284.

41 Friedler, E., Kovalio, R., Galil, N.I. (2005) On-site greywater treatment and reuse in multi-storey buildings. *Water Science & Technology* 51 (10): 187-194.

42 Hernández-Leal, L., Temmink, H., Zeeman, G. and Buisman, C.J.N (2010) Comparison of three systems for biological greywater treatment. *Water* 2: 155-169.



reactors (MBBR)<sup>43</sup>. The treated greywater effluent undergoes a final filtration stage, for example, using a sand filter and/or disinfection to meet the non-potable water reuse standards.

### 3.1.3.1. Rotating biological contactors (RBCs)

A rotating biological contactor (RBC) is a fixed biofilm, aerobic reactor where the media is mechanically rolled up and down in the water. RBCs consist of closely spaced plastic circular discs mounted on a horizontal shaft which slowly rotates perpendicular to the direction of the wastewater flow half-submerged in the wastewater basin. The biofilm that develops on the rotating disc is fed intermittently with water, thus enhancing the degradation of organic matter present in greywater. A sedimentation stage is usually required as post-treatment followed by disinfection. RBCs exhibit a high removal rate of biodegradable organic pollutants (up to 95% of BOD). The system is also characterised by a low energy requirement.

Both hydraulic and organic-loading criteria are used in sizing RBCs for secondary treatment. Properly designed RBC systems are generally very reliable, due to the presence of a large amount of biological mass. This large biomass permits these systems to withstand hydraulic and organic surge loads more effectively.



Figure 11: Rotating biological contactors (RBC) in a multi-storey building. First-generation system for greywater recycling from 1995 (Photo: E. Nolde).

#### Advantages:

- Short hydraulic retention time (HRT) due to large active surface area
- Can handle a wide flow and load variation
- Low sludge production
- Low operational costs and energy requirement
- Good process control

<sup>43</sup> Jabri, K.M., Fiedler, T., Saidi, A., Nolde, E., Ogurek, M., Geissen, S.U. and Bousselmi, L. (2019) Steady-state modeling of the biodegradation performance of a multistage moving bed biofilm reactor (MBBR) used for on-site greywater treatment. *Environmental Science & Pollution Research* 26:19047-19062.



**Disadvantages:**

- High space requirement
- High humidity levels which necessitate proper ventilation in installation room
- Shaft bearings and mechanical drive require frequent maintenance

**3.1.3.2. Moving-bed biofilm reactor (MBBR)**

The Moving Bed Biofilm Reactor (MBBR) is a highly effective biological treatment system based on the activated sludge process (suspended growth) and the fixed-film (immobilised) growth process to remove organics and nutrients from wastewater. It is an aerobic, completely mixed and continuously operated biofilm reactor. The MBBR uses a bed of carrier media (foam cubes, HDPE, etc.), which provides a large surface area for biofilm growth, thus leading to a higher biological activity in the reactor. The biomass in the MBBR exists in two forms: suspended growth in the media and as biofilm attached to carrier media.

The MBBR can be operated at high organic loads as it is less vulnerable to load fluctuations<sup>44</sup>. The carrier media plays a crucial role in system performance. It offers a high specific surface area, which allows microorganisms to attach, grow and form a biofilm. Since the carriers are in continuous movement, the biofilm contributes to a good mass transfer effect, thus increasing the treatment efficiency.



Figure 12: A multi-stage moving bed biofilm reactor (MBBR) for greywater recycling in a residential building (Photo: E. Nolde).

44 Borkar, R.P., Gulhane, M.L. and Kotangale, A.J (2013) Moving Bed Biofilm Reactor - A New Perspective in Wastewater Treatment. IOSR Journal of Environmental Science, Toxicology & Food Technology (IOSR-JESTFT) Volume 6 (6): 15-21.



Figure 13: Aerated moving-bed biofilm reactor (MBBR) (left) and foam cubes as carrier media (Photo: E. Nolde).

**Advantages:**

- High biological activity and treatment efficiency
- Less susceptible to organic load fluctuations
- Complete solids removal
- Reduced sludge production and improved settling characteristics
- Low space requirement
- Low maintenance and operational costs
- Low energy demand
- Low footprint
- No requirement for chemicals
- Carrier media need not be replaced or cleaned (service life over 15 years)

**Disadvantages:**

- High COD:BOD<sup>5</sup> loading could lead to poor settling conditions
- Relocation of carrier media is required prior to emptying of reactor for maintenance work

### 3.1.3.3. Membrane bioreactors (MBR)

Membrane bioreactors (MBRs) are a combination of membrane filtration and biological treatment using the activated sludge process (AS-MBR). The MBR system utilises microporous membranes (0.02 - 0.4 µm) for solid/liquid separation instead of secondary clarifiers. Treated wastewater passes through the membrane under a pressure of 0.1 - 0.3 bar, while sludge is held back by the submerged membrane yielding a high-quality effluent. Indicative effluent quality of microporous membranes includes SS < 1 mg/l, turbidity < 0.2 NTU and up to 4 log removal of viruses (depending on the membrane nominal pore size). Removal of organic material and nutrients from greywater using MBRs is dependent on the biological processes in the MBR rather than the membranes.

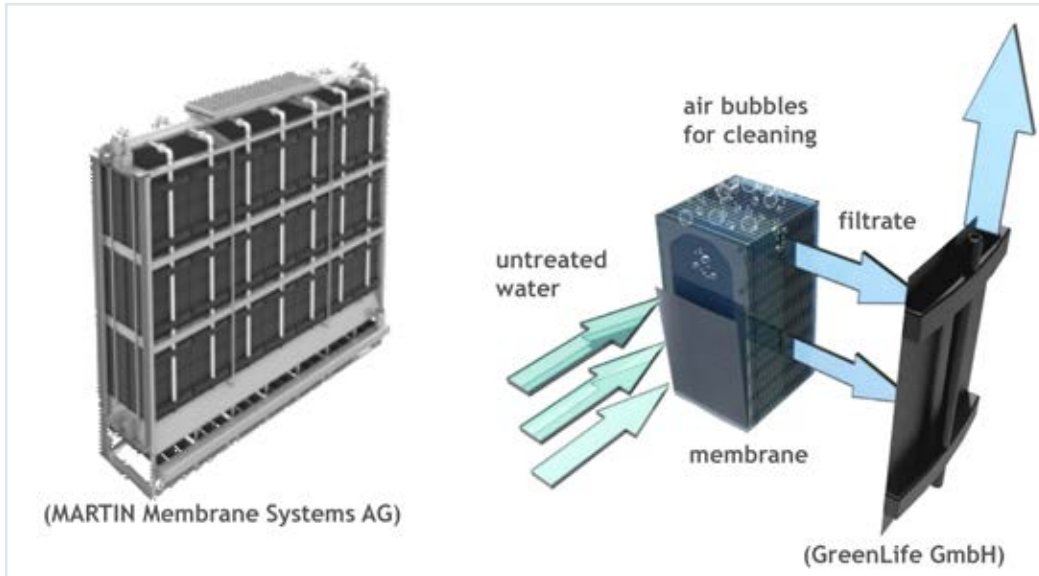

Figure 14: Membrane filters for greywater treatment (left) and its cleaning mechanism.

MBRs require a sedimentation stage as a pre-treatment and less space than traditional activated sludge systems, since less hydraulic residence time (HRT) is needed to achieve a given solids retention time (SRT). MBRs are mostly suitable for low-load greywater and they have the additional advantage that final filtration or sedimentation step of the effluent to remove biomass is not needed. Membrane bioreactors appear to be a very attractive solution due to the high effluent quality. However, they also have several disadvantages such as membrane fouling and clogging and require cleaning and maintenance during long term operation. Consequently, regular backwashing, flushing and chemical treatment are necessary to recover the needed flux.



Figure 15: A modular system (AQUALOOP) of a membrane bioreactor using ultrafiltration for greywater recycling (Source: INTEWA).



Figure 16: A submerged ultrafiltration system (AQQA®) for membrane bioreactors, where the membrane plates are aligned in a box that can be stacked (Source: Weise Water GmbH).



## Membrane fouling

Fouling of membranes is caused by complex physical and chemical interactions between the feedwater (greywater) and the membrane surface. Several variables play a role in the proper membrane functioning, such as the feedwater quality, membrane material and pore size and operating conditions. Control of membrane fouling through optimisation of all these variables has been one of the main topics in MBR development in recent years.

Cleaning of the membrane, which is time and material consuming, can follow mechanically, for example by air scouring or by introducing water at high pressure into the membrane, or chemically using detergents, caustics, acids, antiscalants or dispersants. Cleaning of the membrane is recommended every 3 to 4 months.

### Advantages:

- High and stable effluent quality with high hygienic standards
- High organic loading rate
- Reduced reactor volume
- Compact structure and little space requirement
- Reduced net sludge production
- Reduced footprint due to the elimination of secondary clarifiers and tertiary filtration processes

### Disadvantages:

- Susceptibility to chemicals found in greywater
- Prone to membrane fouling and clogging
- High capital investment (membrane modules) and operation costs
- Require a pre-treatment of the greywater
- Require chemicals for cleaning
- High energy demand

### 3.1.3.4. Nature-based solutions (NBS) for greywater treatment

Nature-based solutions (NBS) for greywater treatment are vegetated systems that exploit the natural purification capabilities of vegetation and bacteria. Among the main NBS are constructed wetlands (CW), living walls (LW) and green roofs (GR). Constructed wetlands can be subsurface flow wetlands or free surface wetlands, the latter usually used as a finishing step. Subsurface flow wetlands consist of waterproof tanks filled with a medium (gravel or sand) in which suitable plant species are grown. The greywater to be treated enters the tank at a horizontal (HF) or vertical (VF) flow, passes through the medium and is then collected at the bottom of the tank through a drainage pipe.





Figure 17: HF system for the separation, treatment and reuse of greywater for toilet flushing in a residential area in Preganziol (TV - Italy)<sup>45</sup>.



Figure 18: VF system for separation, treatment and reuse of greywater for toilet flushing in a Hostel campus of the College of Engineering, Pune (India)<sup>45</sup>.

<sup>45</sup> <http://www.irdra.eu/en/applicazioni-en/recupero-acque-grigie-en.html>



## Thematic Catalogue 2 - PART 2

Green walls or living walls are generally made of modules hung on the walls, composed of several pots filled with a medium in which adequate aquatic vegetated species are grown. These pots are then fed by a feeding system with the greywater that percolates in series through the pots and is then collected by a drainage system.

Green roofs are horizontal vegetated surfaces built on the buildings' roofs, isolated by an impermeable layer on the bottom and the vegetation grows in the layer of growing substrate placed over the impermeable layer. Greywater passes through the substrate layer and is then collected on the bottom via a drainage system.



Figure 19: Green Wall for gardening reuse of treated greywater, Margarita beach, Marina di Ragusa (RG - Italy)<sup>45</sup>.

These systems exploit the complex interaction between the soil, roots of vegetation, water and the atmosphere and lead to a reduction of pollutants through biological degradation, adsorption, filtration, precipitation and plant uptake. NBS have a high capacity to remove TSS, BOD, COD and turbidity if designed with adequate hydraulic loading rate (HLR), hydraulic retention time (HRT) and organic loading rate (OLR), but require a degreaser as pre-treatment. NBS also feature good pathogen removal, however an additional disinfection stage is necessary to reach the limits for non-potable reuse.

The efficiency of CWs in the treatment of greywater is already well known for applications at significant real scales. It has been shown that in combination with an appropriate disinfection stage (chlorination or UV), the treatment efficiencies of the CWs are sufficient for non-potable reuse, with BOD reductions that can reach 98% for RVF systems (Recycled Vertical Flow bioreactors)<sup>46</sup>.

Recent review works confirm the suitability of living walls and green roofs to treat and reuse greywater, with removal rates reaching 90-99% for BOD and COD<sup>47</sup>. Therefore, NBS, if properly designed

46 Arden, S., & Ma, X. (2018). Constructed wetlands for greywater recycle and reuse: A review. In *Science of the Total Environment* (Vol. 630). <https://doi.org/10.1016/j.scitotenv.2018.02.218>

47 Boano, F., Caruso, A., Costamagna, E., Ridolfi, L., Fiore, S., Demichelis, F., Galvão, A., Pisoeiro, J., Rizzo, A., & Masi, F. (2020). A review of nature-based solutions for greywater treatment: Applications, hydraulic design, and environmental benefits. In *Science of the Total Environment* (Vol. 711). <https://doi.org/10.1016/j.scitotenv.2019.134731>



and with adequate degreasers and disinfection systems, can guarantee effluent concentrations that fulfill the limits for most non-potable water reuses.

**Advantages:**

- High purification efficiency and excellent environmental integration
- Robust against load fluctuations (CW)
- Low investment costs and low maintenance (CW) and easier maintenance than technological solutions (LW)
- Reduced surface dimensions compared to constructed wetlands (LW) (GR)
- Possibility of redeveloping building facades (LW)
- Typical additional benefits of green roofs and living walls (thermal insulation, improvement of air quality and the aesthetics of buildings) (LW) (GR)
- Low power consumption possible (gravity feed) (CW) and no additional air for biological removal (LW) (GR)

**Disadvantages:**

- Sufficient surface area is required (CW)
- Innovative technical solution, still few real-scale experiences (LW) (GR)
- High construction costs (GR) (LW) in comparison to constructed wetlands
- Needs a building with high load bearing capacity (GR) (LW)

### 3.2. Disinfection

Disinfection of the treated greywater (service water) is recommended prior to its reuse. Particulate/ suspended matter present in greywater limits the efficacy of disinfection by chlorine, ultraviolet light or ozone by shielding microorganisms. Therefore, it is recommended to reduce the turbidity of the greywater to a very low level for an efficient disinfection of the final product.

UV disinfection is mostly recommended for treated greywater as it a very effective and reliable method and requires little maintenance without the use of any chemicals. The usage life of a UV lamp is approx. 8,000 h depending on the type of emitter and the operating conditions.

Table 8: Different disinfection methods for treated greywater (service water).

Method	Advantages	Disadvantages
Chlorination	Highly effective and fast acting; significant residual cleaning effect; lower costs than other disinfection methods	Can react with organic compounds in greywater to form by-products which are carcinogenic (trihalomethanes, chloramines)
Ultraviolet light (UV)	Highly effective; no chemical requirement; ease of use; no risks of overdosing	No residual effect; efficiency can be affected by the presence of turbidity in the greywater
Ozone	Highly effective against many microorganisms; it is reduced to oxygen; can be produced in-situ	Not very effective in an open system; water turbidity may diminish effectiveness



### 3.3. Maintenance

Maintenance expenditure for greywater recycling systems is dependent on system type and the end use of the treated greywater. For example, membrane bioreactors require more maintenance and monitoring than other biological treatment systems. In general, a maintenance schedule must be set up for each recycling system to ensure a problem-free treatment process and a high service water quality.

### 3.4. Performance

As with rainwater harvesting systems, a good planning, correct dimensioning and installation are crucial for a reliable and durable operation of a greywater recycling system. Modern greywater systems tend not to rely on chemicals and are often designed with fail-safe mechanism which interrupts the supply of greywater and switches to mains water supply, if the system fails to operate properly. More sophisticated control systems are equipped with mechanisms to promptly alert the operator or user of failures.

The performance of a water recycling system will also impact its maintenance schedule. Many greywater systems suffer from operational problems and breakdown, with the result that these systems are quickly abandoned. The most commonly encountered operational problem is the low treatment efficiency of the system, leading to offensive odours and a very poor water quality.

Pumps used in greywater systems are subjected to substantial wear and tear due to the mechanical nature of their operation. The warranty offered by most manufacturers is one year, however the lifespan of pumps is likely to be in the range of 10 years. Some treatment components, such as membrane systems and bulbs in UV disinfection units have relatively short service life, requiring replacement every 1 or 2 years. Biological greywater systems are vulnerable to contamination by certain chemicals that may be found in greywater, which may reduce the biodegradation capacity.

Greywater recycling and reuse should not be viewed only in terms of its economic performance but also in the social and environmental benefits it offers, while contributing towards sustainable development and optimal resource use. Greywater systems offer a greater economic value when used for a wider range of applications such as for toilet flushing, laundry, cleaning and garden irrigation. In general, biological treatment systems for greywater are most efficient and effective for multi-dwelling applications, such as multi-storey residential and office buildings, hotels, sports facilities, etc., where more favourable scales of economy and greywater quality can be achieved by connecting many users to the system.

An automated plant operation can also increase the performance of a greywater recycling system and decrease the costs for operation and maintenance.

### 3.5. Health aspects

Paramount to the acceptance of greywater reuse is the protection of public health. This is reflected in the emerging government policies and regulatory guidelines which include greywater reuse as part of an overall sustainable water strategy. In practice, the health risk of greywater reuse has proven to be minimal. Nevertheless, greywater may contain pathogenic organisms which may cause disease. Therefore, proper treatment, operation and maintenance of greywater recycling systems is indispensable, if any infectious pathways should be intercepted.



Certain precautionary measures should be taken to avoid any health risks from the reuse of greywater:

- Cross-connections between drinking water and greywater plumbing systems should be excluded. This is guaranteed by using different colours and labels for the drinking water and greywater plumbing systems and tapping points
- System overload should be avoided
- Greywater should not be stored untreated.

### 3.6. Environmental impact

Greywater systems bring significant savings in fresh drinking water, in addition to reducing the amounts of generated wastewater, thus easing the pressure on the environment. In general, low-energy systems should be preferred over high expenditure systems.

Greywater recycling systems use electricity for pumps, treatment (e.g. aeration), disinfection and control systems. This ongoing operational energy requirement can be responsible for a considerable proportion of the system's life cycle impact. A case study reported operational energy use for greywater recycling of 1.9 kWh/m<sup>3</sup> <sup>48</sup>, which is consistent with those from greywater systems operated in Berlin, which lie in the range between 1.5 - 3 kWh/m<sup>3</sup>.

### 3.7. Economic benefits

In general, water reuse projects are often undervalued when compared to other water projects due to the failure to properly quantify all benefits of reuse, including social and environmental benefits. If the non-monetary benefits, which encompass social and environmental benefits, could be quantified, the benefits of many water reuse projects would exceed the costs and become economically feasible.

The total costs for a greywater recycling system are usually allocated to the following components:

- Dual piping system
- System technology
- Installation costs
- Operating costs (energy, personnel costs, monitoring)
- Maintenance and repair costs.

Greywater reuse technologies seem to be more economically feasible for multi-storey buildings due to the higher water demand and generated amounts of wastewater. The installation of decentralised greywater recycling technologies in multi-storey buildings is favoured by economies of scale and cost sharing arrangements, where the cost of the system is divided between the residents.

Greywater recycling is not yet widely accepted, partly due to the apparently low economic benefit, particularly in commercial buildings such as offices, where low volumes of greywater are produced daily. However, with the rise in water costs and the increased pressure placed upon aging and deteriorating water and wastewater infrastructure, solutions which reduce the freshwater demand, such

<sup>48</sup> Brewer, D., Brown, R. and Stanfield, G. (2001) Rainwater and greywater in buildings. Project report and case studies. BSRIA Technical Note TN 7/2001



## Thematic Catalogue 2 - PART 2

as greywater recycling, are becoming financially more viable. Given that the utility service infrastructure created to support buildings typically has a design life of 20 - 40 years, adoption of systems that might be marginally more expensive now, but deliver considerable benefits in the future, should be seriously considered and implemented.

Depending on the local water costs, drinking water availability and the used recycling technology, an amortisation period of less than 10 years can be usually achieved today with greywater recycling systems which are available on the market.



## 4. Best practice

### 4.1. “Block 6” integrated water concept

The integrated water concept “Block 6” includes both rainwater management and greywater recycling at an urban, residential level. Low and high load greywater from 71 apartments is treated and reused for toilet flushing and irrigation by approx. 250 persons in a multi-storey residential block in the centre of Berlin<sup>49</sup>.

Following a reconstruction and optimisation phase in 2006, greywater is treated in a multi-stage moving bed biofilm reactor (MBBR) and the recycled effluent is reused for toilet flushing and irrigation in three residential buildings. The high-quality effluent is eventually disinfected with UV light, before it is pumped to the points of use. In addition to greywater from bathtubs, showers and hand washbasins, the system also treats high load greywater from kitchen sinks and laundry and exhibits high efficiency and stability since 2006.

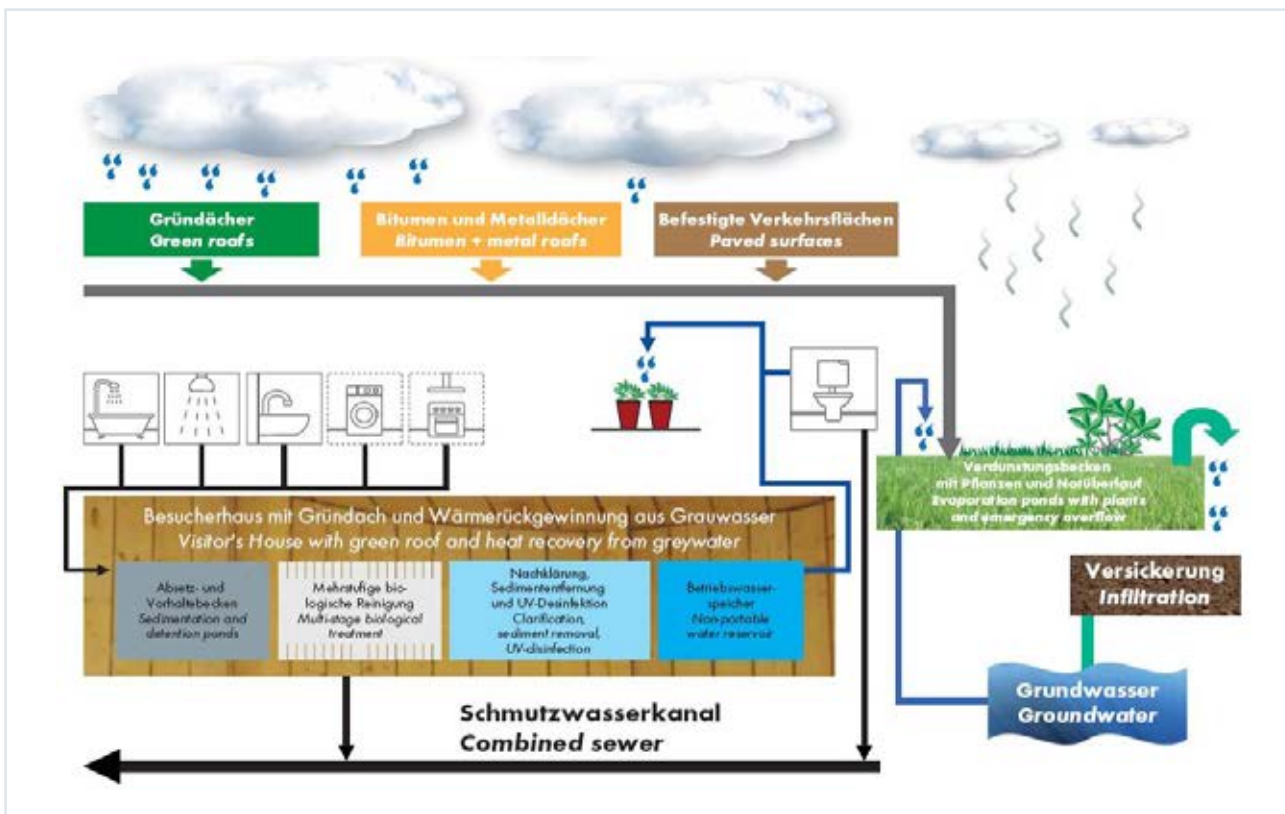

Figure 20: Schematic diagram of the integrated water concept “Block 6” in the centre of Berlin.

<sup>49</sup> Berlin Senate. Block 6: Integrated Water Concept - Ecological Integrated Concept. Berlin Senate Department for Urban Development and Housing. [https://www.stadtentwicklung.berlin.de/bauen/oekologisches\\_bauen/download/modellvorhaben/flyer\\_block6\\_engl.pdf](https://www.stadtentwicklung.berlin.de/bauen/oekologisches_bauen/download/modellvorhaben/flyer_block6_engl.pdf)



Figure 21: The so-called “water house” containing the greywater recycling system (above) and a schematic diagram of the different MBBR treatment stages. The aerated MBBR with carrier media (below right).





## Thematic Catalogue 2 - PART 2

Table 9: Project Data for Block 6.

Integrated water concept „Block 6“: 1987 - 1993		
Phase I	Rainwater Management	Greywater Recycling
Site description	A block of 3 multi-storey residential buildings with approx. 250 persons in the centre of Berlin	
Infrastructure	Dual pipe system, water-saving fittings and measures, water metres; disconnection from municipal sewer (no rainwater fees due)	
Space requirement	100 m <sup>2</sup> reed bed + rainwater pond	900 m <sup>2</sup> reed bed
System design	Rainwater pond bordering the constructed wetland; reed bed; evaporation	Constructed wetland: 790 m <sup>2</sup> planted soil filter + 110 m <sup>2</sup> maturation pond
Rainwater/greywater sources and reuses	2,350 m <sup>2</sup> roof surfaces 650 m <sup>2</sup> sealed surfaces	Hand washbasins, showers, bath tubs, <b>kitchen and washing machines</b> <u>Reuses</u> : toilet flushing and irrigation
Problems		High evaporation rates, massive algal growth, clogging of soil filter. Constructed wetland was shut down in 1993 due to high operating costs
Integrated water concept „Block 6“: Since 2006		
Phase II*	Rainwater Management	Greywater Recycling
Space requirement	1,000 m <sup>2</sup>	50 - 100 m <sup>2</sup> placed on former maturation pond site
System design	Rainwater pond and a vegetated swale; evaporation, reed beds	Biological-mechanical treatment using a multi-stage moving-bed biofilm reactor (MBBR) followed by UV disinfection Daily treatment capacity: 10 m <sup>3</sup>
Rainwater/greywater sources and reuses	2,350 m <sup>2</sup> roof surfaces 650 m <sup>2</sup> sealed surfaces	Hand washbasins, showers, bath tubs, <b>kitchen and washing machines</b> <u>Reuses</u> : toilet flushing and irrigation
Advantages		Less space requirement, higher process stability, high service water quality, low maintenance and operating costs; annual savings in drinking water: 3 million litres

\*Following decommissioning of the first-generation greywater system and reconstruction.

Technical data	
Inflow COD concentrations	500 - 1,000 mg/l
Pre-treatment	Grease/grit chamber and sieve
Moving-bed biofilm reactor (MBBR)	10 tanks with a capacity of 1.5 m <sup>3</sup> each
Post-treatment	Sand filter
UV disinfection unit	50 Watt
Other units	Booster pump, mains water backup supply
Service water price	3.50 €/m <sup>3</sup>



## Thematic Catalogue 2 - PART 2

In another project<sup>50</sup>, treated greywater and blackwater generated in the water house were used in a 50 m<sup>2</sup> experimental greenhouse in an integrated aquaponic (combined fish and plant farming) and hydroponic system (soilless plant farming) modules for urban food production (fish and vegetables). The resulting products were tested and they showed high and safe quality for human consumption.

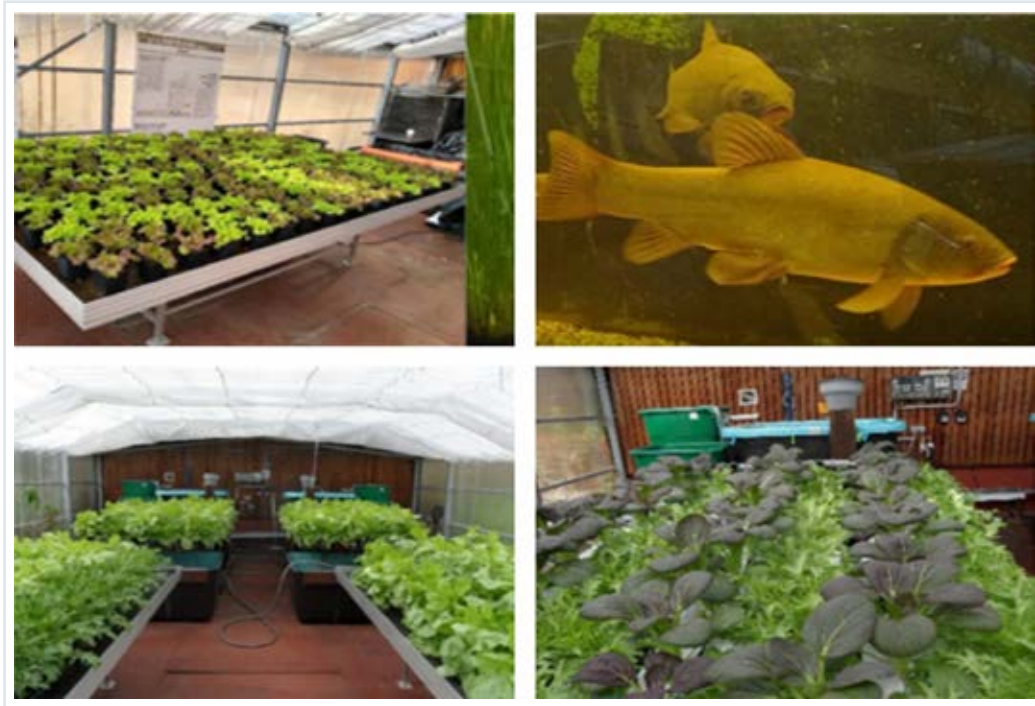

Figure 22: Urban aquaponic and hydroponic systems using treated greywater and wastewater in Block 6.

<sup>50</sup> <http://www.roofwaterfarm.com/>



## 4.2. Arnimplatz

In a multi-storey building in Berlin with 123 tenants, a greywater recycling system combined with heat recovery from greywater was installed in 2011, which supplies the residents with 3 - 4 m<sup>3</sup> per day with high-quality service water for toilet flushing. The investment costs for the system including installation costs were 11.38 €/m<sup>2</sup> of living space. Savings for 2019: 1,300 m<sup>3</sup> in drinking water and 14 MWh in heat energy.

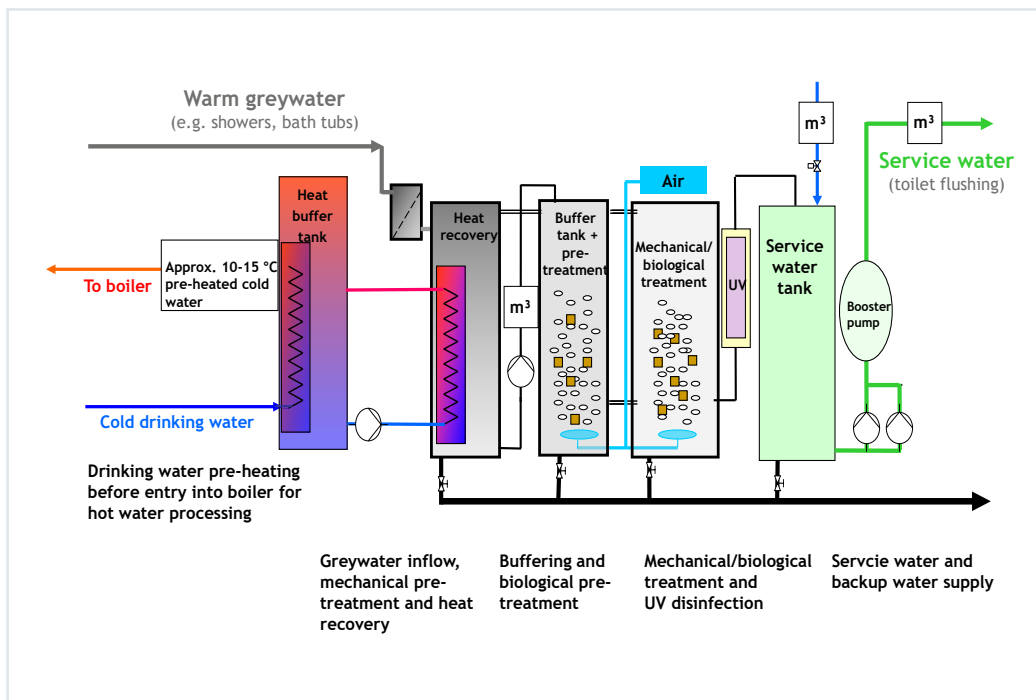

Figure 23: A schematic diagram of the greywater recycling system (MBBR) at Arnimplatz, in combination with heat recovery from greywater.



Figure 24: The greywater recycling system including heat recovery from greywater in the cellar of the building.

Table 10: Project data for Arnimplatz.

Living space	4,600 m <sup>2</sup>	Number of tenants	123
Number of flats	41	Commercial area	650 m <sup>2</sup>
Underground car park	23	Number of commercial units	4
Land area	2,083 m <sup>2</sup>	Gross floor space	6,620 m <sup>2</sup>
Heat insulation	26 cm	Garden area	1,100 m <sup>2</sup>
Space heating	73,400 kWh/a	Warm water heating	103,636 kWh/a (284 kWh/d)
Gas heating operated by CHP plant	16 kW <sub>elec.</sub> 35 kW <sub>therm.</sub>	Photovoltaic: 92 Modules mit 20 kWp	18,000 kWh/a
<b>Greywater recycling and heat recovery</b>			
Greywater recycling	3 m <sup>3</sup> /d (1,000 m <sup>3</sup> /a)	Heat recovery from greywater	12.5 kWh <sub>therm.</sub> /m <sup>3</sup> approx. 13,000 kWh/a
Water quality: BOD <sub>5</sub>	< 3 mg/l	Water quality: turbidity measurement	< 1- 2 NTU
Water quality: Hygiene	In accordance with the EU-Guidelines for Bathing Water		
Total area for greywater recycling and heat recovery plant	9 m <sup>2</sup>	Total plant costs (incl. installation and taxes) per m <sup>2</sup> living space	11.30 €/m <sup>2</sup>



## Thematic Catalogue 2 - PART 2

Technical data	
Inflow COD concentrations	approx. 200 mg/l
Pre-treatment	Sieve
Moving-bed biofilm reactor (MBBR)	3 tanks with a capacity of 1 m <sup>3</sup> each
Post-treatment	Integrated sedimentation in the final bioreactor
UV disinfection unit	50 Watt
Other units	Booster pump, mains backup system
Electricity demand (greywater + heat recovery)	2,300 kWh
Service water price	3.50 €/m <sup>3</sup>

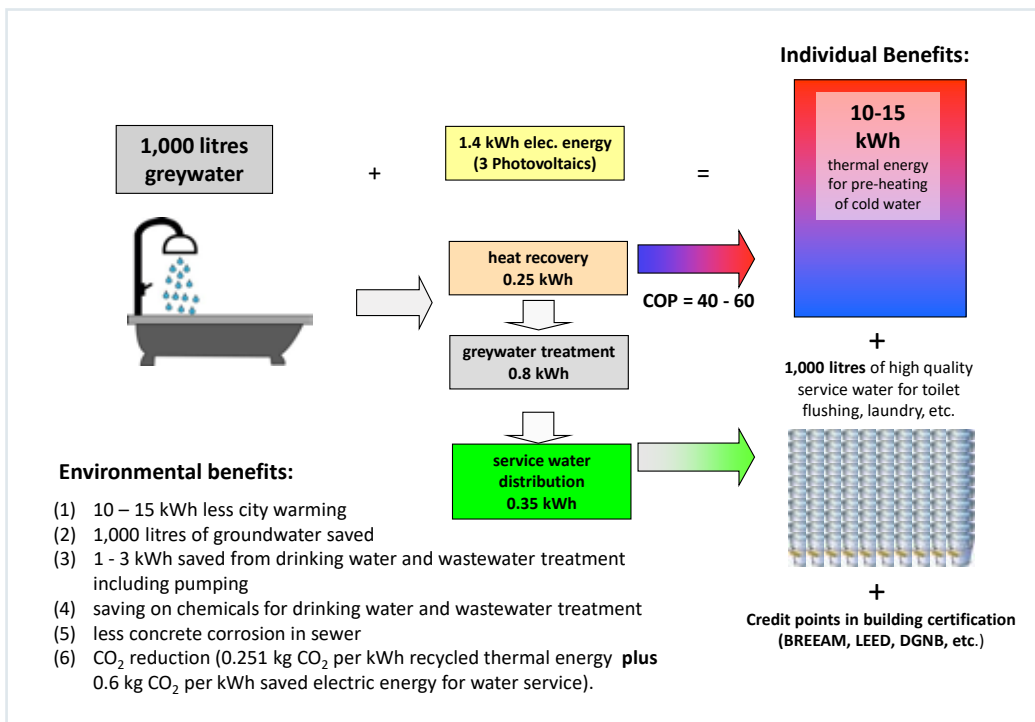

Figure 25: Estimated individual and environmental benefits from greywater recycling in combination with heat recovery at Arnimplatz.

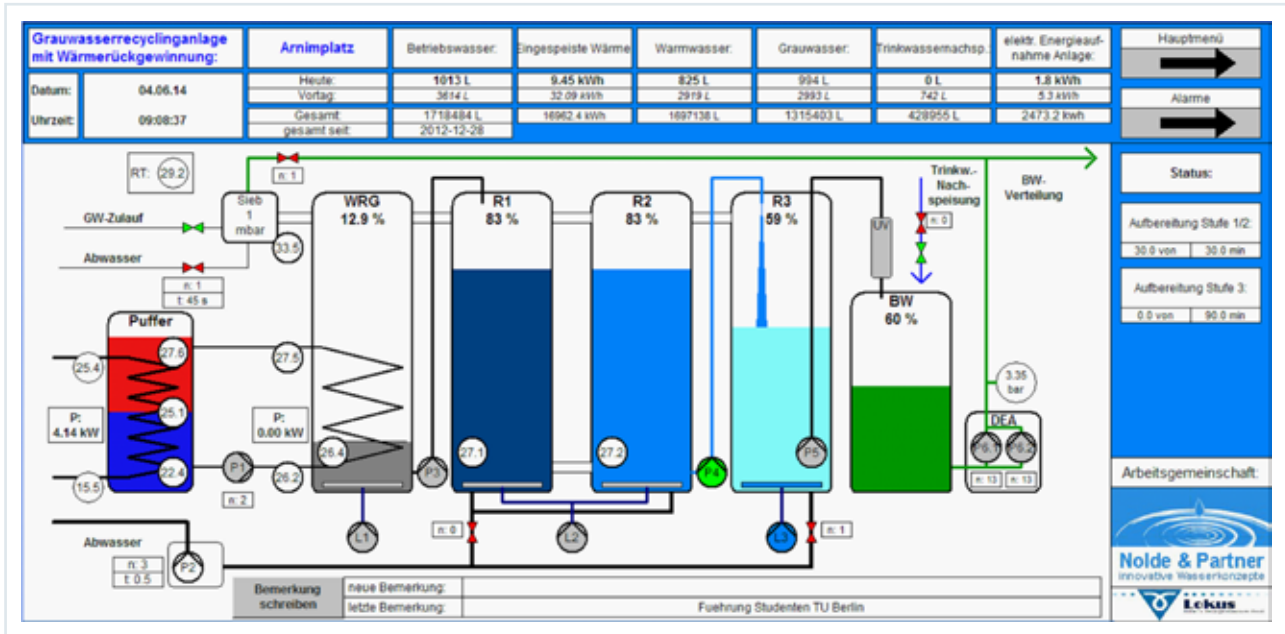

Figure 26: Control and monitoring of greywater recycling and heat recovery using a smart metering and telemetry system.

Table 11: Environmental and financial benefits from greywater recycling and heat recovery in 2020.

Environmental benefits at Arnimplatz (greywater recycling with integrated heat recovery)	
SAVINGS in 2020	
1,152,856	Litres of drinking water
1,152,856	Litres of wastewater (which had been recycled)
0	Chemicals used for water treatment
0	kWh <sub>elec.</sub> No additional power expenditure compared to the conventional water treatment
15,345	kWh <sub>therm.</sub> less global warming
1,534	m <sup>3</sup> of natural gas as a result of heat recovery from greywater*
3,713	kg CO <sub>2</sub> are avoided as a result of the heat recovery compared to water heating with natural gas*

\* Primary energy factor (ENEV) = 1.1; 0.22 kg CO<sub>2</sub> / kWh; 10 kWh/m<sup>3</sup> natural gas



### 4.3. Arabella-sheraton-Hotel in Offenbach

Greywater from bathtubs and showers from the 221 hotel rooms is collected in pre-sedimentation tanks. Following preliminary sedimentation, greywater is treated in 6-stage Rotating Biological Contactors (RBC). Oxygen needed for the biological degradation is supplied by the revolving rotors in the RBC vessels. Excess sludge is directly discharged into the sewer. The final effluent is disinfected with UV light and stored in the service water tank, from where it is pumped for reuse in toilet flushing and for open space irrigation. The greywater system is designed for a capacity of 20 m<sup>3</sup>/day<sup>51</sup>.

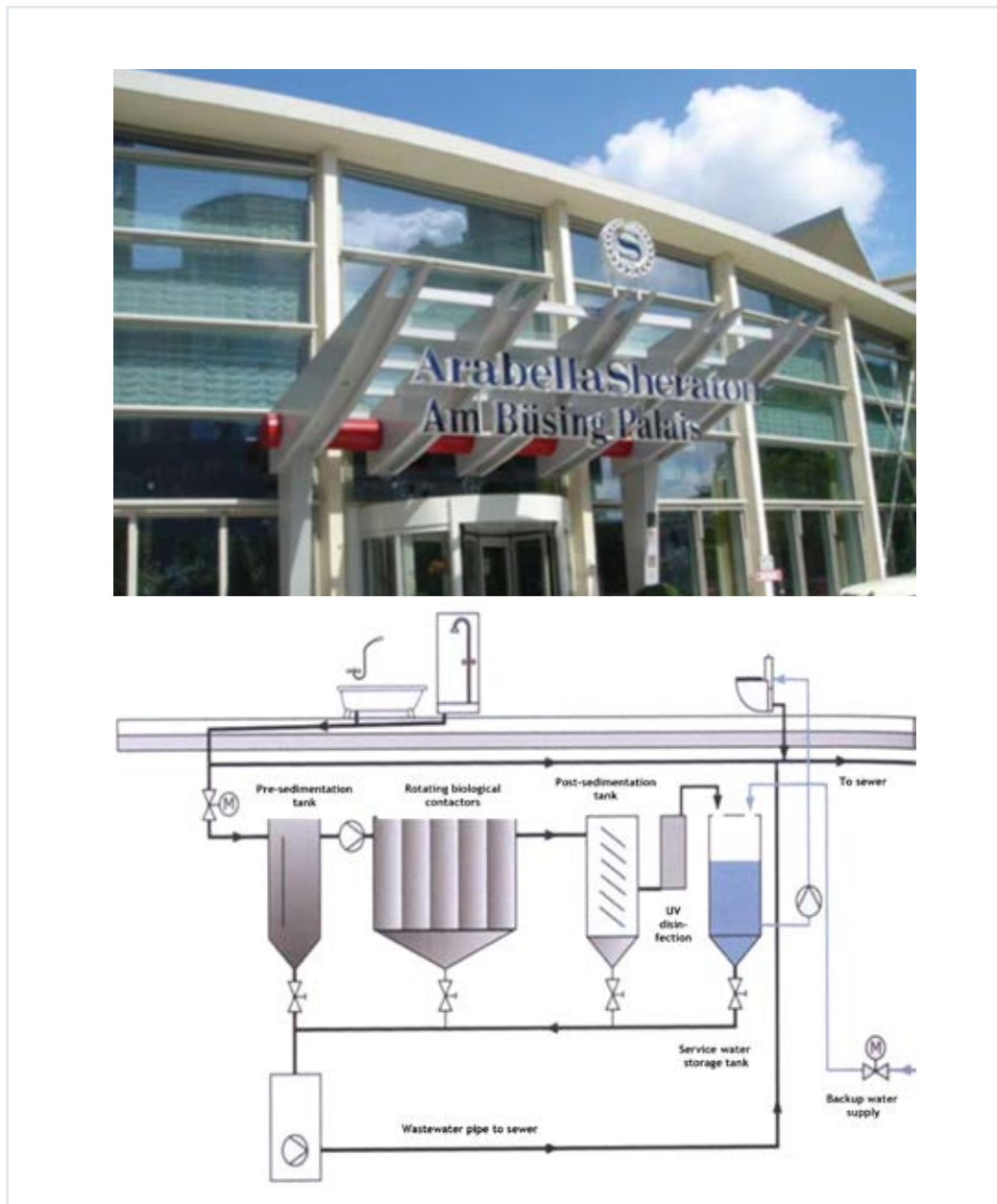

Figure 27: Schematic diagram of the RBC system in Arabella-Sheraton Hotel (E.Nolde).

51 Werner, C. et al. (2006) Greywater recycling in Hotel ArabellaSheraton Am Büsing Palais in Offenbach, Germany - Data sheets for ecosan projects. Sustainable Sanitation alliance <https://www.susana.org/en/knowledge-hub/resources-and-publications/library/details/1989?pgrid=1>



Figure 28: The greywater recycling system with the 6 RBC modules and the post-sedimentation tank.

Table 12: Project data for hotel greywater system.

Greywater recycling in 4-star hotel, ArabellaSheraton in Offenbach	
Description	First generation of biological greywater recycling systems in Germany
Treatment system	Multi-stage rotating biological contactors (RBCs)
Start of operation	01/1996
Cleaning capacity	20 m <sup>3</sup> /d (221 rooms, 380 beds)
Space requirement	2 parking lots, 5.7 m x 6.7 m = 38 m <sup>2</sup>
Greywater sources	Showers and bath tubs
Reuse options	Toilet flushing, irrigation
Total energy demand	1.35 kWh/m <sup>3</sup> including service water distribution
Water savings	5,000 m <sup>3</sup> /a; payback period < 7 years
Technical data	
Greywater collection pipes	DN150 x 2
Collection and pre-sedimentation tanks	6.8 m <sup>3</sup> in total
Rotating biological contactors	6 x 1 m <sup>3</sup> Total HRT: 8 h
Sedimentation tank	2.4 m <sup>3</sup>
UV-Disinfection unit	50 Watt
Service water tanks	6.8 m <sup>3</sup> in total
Booster pump station	3 x 1 kW pumps, 5 bar





		Total Annual costs (Euro/year)
<b>Initial investment</b>		
Treatment system incl. planning	72,000 €	
Dual piping system incl. planning	approx. 100,000 €	
<b>Operational costs</b>		
Energy costs	Energy demand: 1.35 kWh/m <sup>3</sup> of treated greywater Electricity price: 0.3 €/kWh	2000
Internal maintenance costs		1,040
Maintenance by manufacturer		1,200
Repair costs		1,440
<b>Cost savings</b>		
Reduction in drinking water consumption	5,000 m <sup>3</sup> of drinking water saved per year (drinking water price: 6 €/m <sup>3</sup> )	30,000

#### 4.4. Greywater recycling using membrane bioreactor in a residential building

In a multi-storey building in Berlin, a membrane bioreactor (MBR) treats the greywater from 123 persons with a treatment capacity of 4 m<sup>3</sup> per day.

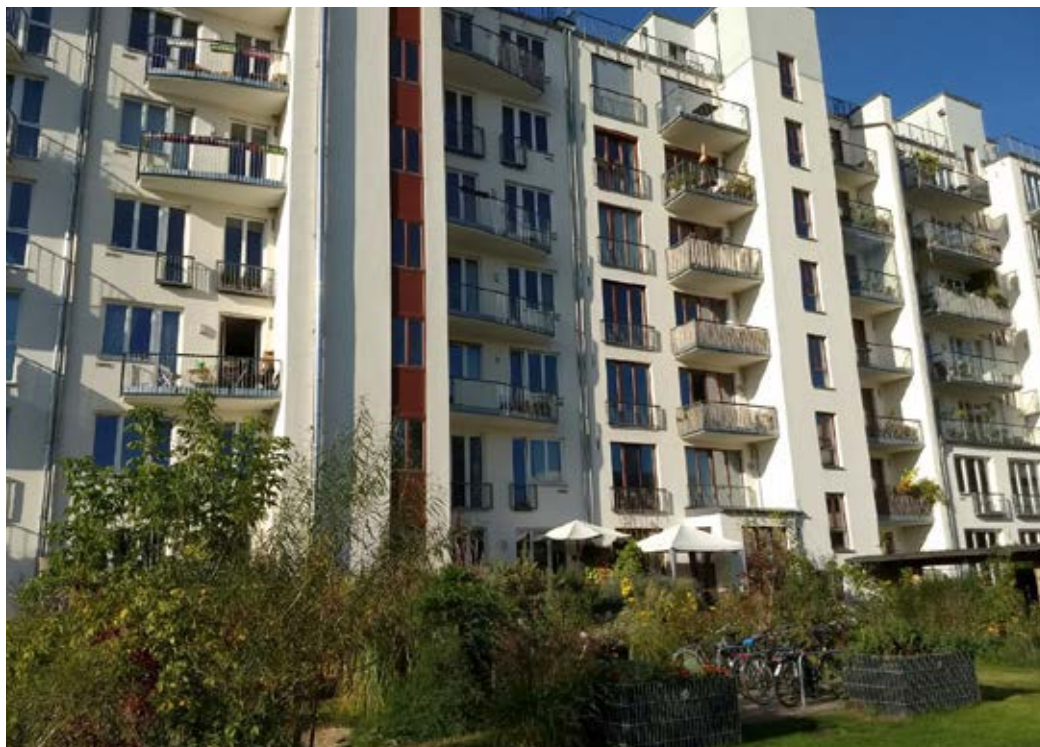



Table 13: Project data.

Greywater recycling using membrane bioreactor (MBR)	
Site description	<ul style="list-style-type: none"><li>○ A multi-storey building in Berlin</li><li>○ Greywater input from 55 apartments</li><li>○ Greywater sources: showers and bathtubs only</li><li>○ Use of recycled water in 63 apartments for toilet flushing</li></ul>
Start of operation	2018
Space requirement	3 m <sup>2</sup>
GW Collection	Outdoor greywater collection in a 5 m <sup>3</sup> concrete cistern
System design	Greywater treatment takes place indoors (cellar) in a membrane bioreactor (MBR); booster pump unit also placed in the cellar
Treatment capacity	4 m <sup>3</sup> /d
Energy consumption	1.5 kWh/m <sup>3</sup> for MBR 2.3 kWh/m <sup>3</sup> for total system operation
Operation	<ul style="list-style-type: none"><li>○ 2015-2018: Initial problems with membrane fouling and clogging</li><li>○ Restructuring and installation of new membrane</li><li>○ Since 05/2018 trouble-free operation and high water quality effluent following membrane replacement and installation of a new electronic device</li></ul>

## 4.5. Keracoll “GreenLab” near Sassuolo, Italy

The Keracoll “GreenLab”, a research centre in Sassuolo, uses natural filtration systems for the recovery of rainwater, which is then reused for irrigation and bioclimatic cooling. The greywater from the toilets and changing rooms is collected separately and treated with a compact system of the SBR type installed inside the building. The irrigation systems of the green areas are fed with both the surplus of purified greywater not reused for toilets, and rainwater recovered from the roofs and filtered in rain gardens. Harvested rainwater is also used to feed an open water basin, designed for bioclimatic purposes. Moreover, water-saving devices are applied to the different delivery points (electronic taps for bathroom sinks, thermostatic taps for showers in changing rooms, toilet cisterns with double button and dry urinals).

These interventions allow a significant decrease in the quantities of water withdrawn from the aqueduct. For the sole reuse for toilet flushing, approx. 3 m<sup>3</sup>/day, equal to approximately 700 m<sup>3</sup>/year, can be saved, while as much as 700-800 m<sup>3</sup>/year of water can be saved by tapping into the collection tanks for the irrigation of the green areas (about 3,000 m<sup>2</sup>) and washing of the yards.



Figure 29: Keracoll “Green Lab” view (up), open water tank and rain garden (down). Source: Bios IS Srl ([www.bios-is.it](http://www.bios-is.it)) and IRIDRA Srl ([www.iridra.com](http://www.iridra.com)).

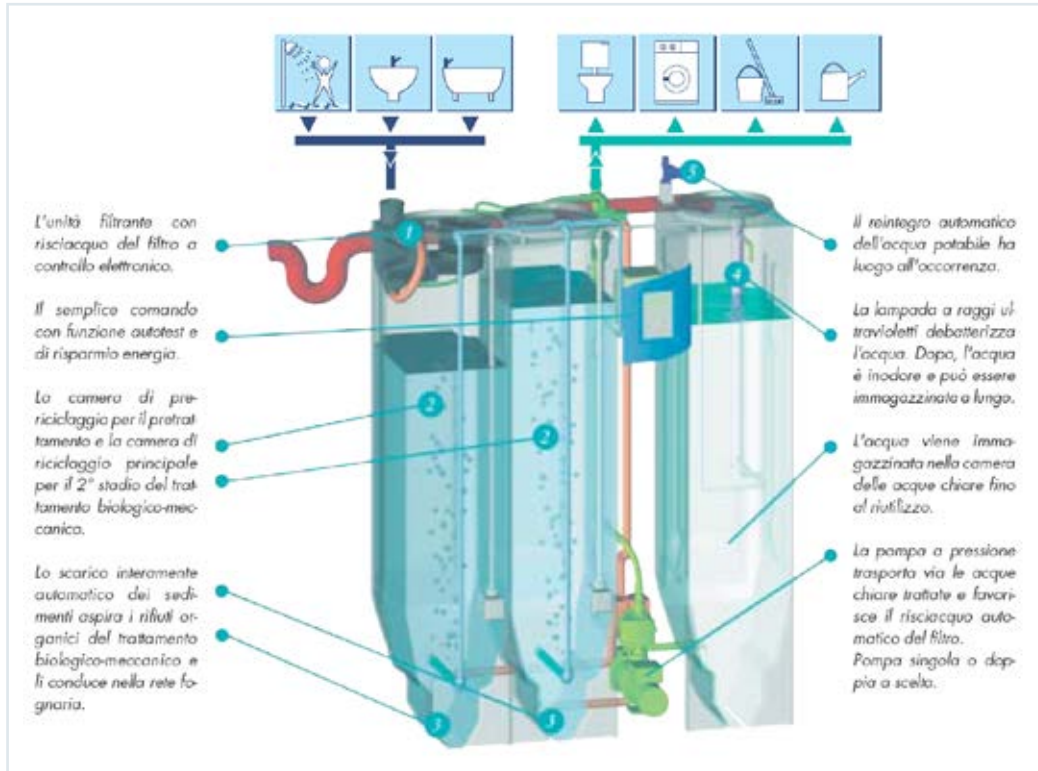

Figure 30: SBR system used for the treatment of the Kerakoll “Green Lab” greywater (Source: Bios IS Srl [www.bios-is.it](http://www.bios-is.it)).

Table 14: Project Data for Kerakoll “GreenLab”.

Greywater recycling in Keracoll GreenLab	
<b>Description</b>	Research center
<b>Number of employees</b>	100
<b>Rainwater sources</b>	Parking and Rooftop raingarden
<b>Greywater sources</b>	toilets and changing rooms
<b>Reuse options</b>	toilets, irrigation, and bioclimatic cooling
<b>Water savings</b>	700 m <sup>3</sup> /year for toilets 700-800 m <sup>3</sup> /year for irrigation
Technical data	
<b>Treatment system</b>	SBR (Sequencing Batch Reactor)
<b>Treatment potential</b>	3000 L/day
<b>Maximum power</b>	4,5 KW
<b>Average current consumption</b>	3,2 kWh/gg



## 5. Additional bibliography

DWA (2019) DWA-Topics BIZ-11.4 E: Non-Potable Water Reuse - Development, Technologies and International Framework Conditions for Agricultural, Urban and Industrial Uses. German Association for Water, Wastewater and Waste (DWA), Hennef.

DWA (2014) Working Paper DWA-A 272E: Principles for the planning and implementation of New Alternative Sanitation Systems (NASS). The German Association for Water, Wastewater and Waste (DWA), Hennef.

Li, Z., Boyle, F. and Reynolds, A. (2010) Rainwater harvesting and greywater treatment systems for domestic application in Ireland. *Desalination* 260: 1-8.

Parkes, C., Kershaw, H., Hart, J., Sibille, R. and Grant, Z. (2014) Energy and carbon implications of rainwater harvesting and greywater recycling. Report: SC090018. Environment Agency, UK. <https://www.gov.uk/government/publications/energy-and-carbon-implications-of-rainwater-harvesting-and-greywater-recycling>

Ridderstolpe, P. (2004) Introduction to greywater management. EcoSanRes Publications Series. Report 2004-4. EcoSanRes Programme. Stockholm Environment Institute (SEI).

USEPA (2012) Guidelines for Water Reuse. EPA/600/R-12/618. US Environmental Protection Agency Washington, Cincinnati.

WHO (2006) Overview of Greywater Management: Health Considerations. World Health Organisation (WHO), Regional Office of the Eastern Mediterranean, Centre for Environmental Health Activities (CEHA), Geneva.

WHO (2006) Guidelines for the Safe Use of Wastewater, Excreta and Greywater. World Health Organisation.

**Volume 1:** Policy and regulatory aspects

[https://www.who.int/water\\_sanitation\\_health/publications/gsuweg1/en/](https://www.who.int/water_sanitation_health/publications/gsuweg1/en/)

**Volume 2:** Wastewater use in agriculture

[https://www.who.int/water\\_sanitation\\_health/publications/gsuweg2/en/](https://www.who.int/water_sanitation_health/publications/gsuweg2/en/)

**Volume 3:** Wastewater and excreta use in aquaculture

[https://www.who.int/water\\_sanitation\\_health/publications/gsuweg3/en/](https://www.who.int/water_sanitation_health/publications/gsuweg3/en/)

**Volume 4:** Excreta and greywater use in agriculture

[https://www.who.int/water\\_sanitation\\_health/publications/gsuweg4/en/](https://www.who.int/water_sanitation_health/publications/gsuweg4/en/)

WWDR (2017) Wastewater - The Untapped Resource. The United Nations World Water Development Report 2017. <https://www.unwater.org/publications/world-water-development-report-2017/>

Zimmermann, M., Felmeden, J. and Michel, B. (2018) Integrated Assessment of Novel Urban Water Infrastructures in Frankfurt am Main and Hamburg, Germany. *Water* 10, 211. doi:10.3390/w10020211. <https://www.mdpi.com/2073-4441/10/2/211/htm>



Thematic Catalogue 2

**ANNEX**

Rainwater management tools

**Annex**



FACT SHEET: INFILTRATION TRENCH	
DESCRIPTION	An infiltration trench is a linear, shallow excavation which is filled with permeable granular material (e.g. gravel/stone) or infiltration boxes that collect surface water runoff from impermeable surfaces and filter it gradually into the ground. Runoff is stored in the voids allowing it to slowly infiltrate through the soil matrix, thus acting as a temporary underground reservoir
FUNCTION	Peak flow reduction and temporary storage and treatment of runoff followed by its gradual infiltration into the ground
SITE AND SELECTION CRITERIA	<ul style="list-style-type: none"><li>• Applied in soils with low or alternating soil permeabilities</li><li>• Best located alongside or adjacent to impermeable surfaces such as roads or car parks</li><li>• They are generally restricted to relatively flat sites</li><li>• Due to their narrow shape, they are easy to integrate into a site with minimal land requirement</li><li>• They should not be installed immediately adjacent to buildings, shrubs or trees</li></ul>
CLEANING PERFORMANCE	Provide a good quality treatment through sedimentation, filtration and biodegradation
DIMENSIONING	<ul style="list-style-type: none"><li>• The maximum catchment area for an infiltration trench should be less than 5 hectares</li><li>• Infiltration trenches are usually 1-2 m deep and filled with stone aggregate. The void ratio of the aggregate fill material should be sufficiently high to allow adequate infiltration and reduce the risk of blockage (40 - 60 mm in diameter)</li><li>• The size of the underground storage reservoir is dependent on the permeability of soil, the amount of throttled flow to be discharged and on the total volume of the filling material (gravel fillings have a void volume of 40%; plastic filling material 95%)</li><li>• Sizing: 300 - 400 m<sup>3</sup>/ha (depending on the kf of soil)</li><li>• Usually wrapped in nonwoven geotextile membrane (top, sides, and bottom) to prevent entry of sediment into reservoir causing clogging</li><li>• Perforated drainpipe (minimum inside diameter 100 mm) should extend along the length of the trench</li><li>• Treatment volume should completely infiltrate through the trench bottom within 24 hours</li><li>• The longitudinal slope should not exceed 2% to enhance pollutant removal and sedimentation</li><li>• The maximum side slopes should be 1:3</li></ul>



## Thematic Catalogue 2 - ANNEX

APPLICATION AREAS	<ul style="list-style-type: none"><li>• Applicable on residential, commercial and industrial sites</li><li>• Infiltration trenches are generally designed to collect and infiltrate runoff from a small area such as a car park or roof surfaces</li><li>• Usually applied for the treatment of surfaces with low sediment load such as from green and non-metal roofs, car parks and pedestrian surfaces. For other surfaces, a pre-treatment of the rainwater is necessary (e.g. swale, filter strip)</li><li>• Infiltration trenches are also ideal for use around playing fields, recreational areas or public open space</li></ul>
BENEFITS	<ul style="list-style-type: none"><li>• Provide temporary storage of water</li><li>• Reduce runoff volume and peak flow</li><li>• Promote infiltration and sedimentation</li><li>• Provide runoff treatment through filtration and adsorption</li><li>• Promote groundwater recharge</li><li>• Low-space requirement</li></ul>
LIMITATIONS	<ul style="list-style-type: none"><li>• Potential for clogging in areas with high sediment load</li><li>• Potential for underground contamination</li><li>• Operational problems not always visible at the surface</li><li>• The possibility of replacing an infiltration trench once every 5 years should be considered due to clogging</li><li>• Poor accessibility to the trench for maintenance requirements</li><li>• Provide no aesthetic benefits</li></ul>
COMBINATION POSSIBILITIES	In combination with rainwater harvesting or a vegetative swale (swale-trench system) or other pre-treatment measures
MAINTENANCE	<p>Regular inspection and maintenance are required for the removal of debris and litter from site. Other maintenance needs: inspection and clearing of inlets, outlets and inspection points for signs of clogging, silt removal from pre-treatment features and inspection and removal of silt from chambers and pipes as required. Remedial work includes removal and replacement of filter drain stone as required and replace clogged geotextile and reinstate</p> <p>Lifespan is 5 - 10 years depending on maintenance</p>
COSTS	Infiltration trenches require significant raw materials, likely to use a tonne of stone per 3 m trench. Maintenance and replacement costs may be high. Construction costs for infiltration trenches vary depending on the depth and site-specific conditions. The system is on average moderately cost-effective. Capital cost ranges are between 70 and 90 €/m <sup>3</sup> of runoff storage



## Thematic Catalogue 2 - ANNEX

PERFORMANCE	
Peak flow reduction	High
Volume reduction	Medium
Slow runoff	Low
Retention of suspended solids	Medium
Water quality treatment	Medium
Water storage	Medium
Groundwater recharge	High
Biodiversity	Low
Amenity potential	Low

## References

Anglian Water. Towards sustainable water stewardship. Sustainable drainage systems (SUDS) adoption manual. Anglian Water Services Limited.

[https://www.anglianwater.co.uk/siteassets/developers/aw\\_suds\\_manual\\_aw\\_fp\\_web.pdf](https://www.anglianwater.co.uk/siteassets/developers/aw_suds_manual_aw_fp_web.pdf)

Minnesota Stormwater Manual. Minnesota pollution Control Agency.

[https://stormwater.pca.state.mn.us/index.php?title=Main\\_Page](https://stormwater.pca.state.mn.us/index.php?title=Main_Page)

Sieker - Die Regenwasserexperten: <https://www.sieker.de/de/home.html>

Woods Ballard, B., Wilson, S., Udale-Clarke, H., Illman, S., Scott T., Ashley, R. and Kellagher, R. (2015) The SuDS Manual. Department for Environment, Food and Rural Affairs. CIRIA 2015.

[https://www.susdrain.org/resources/SuDS\\_Manual.html](https://www.susdrain.org/resources/SuDS_Manual.html)





FACT SHEET: DETENTION BASINS	
DESCRIPTION	Detention basins are dry, vegetated depressions designed to temporarily store runoffs and either allow it to infiltrate into the ground or flow out at a controlled rate. They are usually designed as landscape features that allow other uses when dry, including playground, sports facility or habitat creation
FUNCTION	Control of runoff peak rate by temporarily storing rainwater and releasing it slowly once the risk of flooding has passed
SITE AND SELECTION CRITERIA	<ul style="list-style-type: none"><li>• Detention basins require a large accessible area which is relatively flat</li><li>• Should not be sited on unstable ground</li><li>• Should be integrated into the design of the site to provide visual, social and biodiversity benefits and a valued landscape space</li></ul>
CLEANING PERFORMANCE	Good cleaning capacity through sedimentation, adsorption and biological processes
DIMENSIONING	<ul style="list-style-type: none"><li>• Detention ponds should be designed to receive silt-free runoffs with low pollution load</li><li>• Runoff should flow into the basin as controlled sheet flow to reduce the risk of erosion</li><li>• Detention basins should have a 2:1 to 5:1 length to width ratio to provide maximum sedimentation at the inlet and runoff filtration</li><li>• Typical depth: 3 - 5 m</li><li>• Typical sizing: approx. 500 - 5000 m<sup>3</sup> depending on the drainage area to be treated</li><li>• A gentle fall to the outlet of about 1 in 100 is required to encourage surface sheet flow by gravity</li><li>• Side slopes to the basin should be 1:3 maximum</li><li>• Detention basins require an overflow to allow for design exceedance or outlet blockage</li><li>• 75-100 mm grass or meadow vegetation provides enhanced treatment and a resilient surface for informal use</li></ul>
APPLICATION AREAS	<ul style="list-style-type: none"><li>• Widely applicable on residential, commercial and industrial sites</li><li>• Detention basins should not be built on, but can be used for sports and recreation and be part of public open space</li></ul>
BENEFITS	<ul style="list-style-type: none"><li>• Reduce runoff peak rate</li><li>• Manage a wide range of rainfall events</li><li>• Simple to design and construct</li><li>• Easy to maintain</li><li>• Potential for dual use</li><li>• Long lifespan (over 20 years)</li></ul>



## Thematic Catalogue 2 - ANNEX

LIMITATIONS	<ul style="list-style-type: none"> <li>• Little reduction in runoff volume</li> <li>• High land-take measure limiting land use in high density areas</li> </ul>
COMBINATION POSSIBILITIES	Ideally combined with upstream SUDS features to reduce silt entering the basin
MAINTENANCE	Regular maintenance includes litter removal, cleaning of inlet and outlet, vegetation management and sediment monitoring and removal when required
COSTS	Similar to retention ponds

### PERFORMANCE

Peak flow reduction	Medium
Volume reduction	Low
Slow runoff	High
Retention of suspended solids	Medium
Water quality treatment	Medium
Water storage	High
Groundwater recharge	None to High
Biodiversity	High
Amenity potential	Medium

## References

Anglian Water. Towards sustainable water stewardship. Sustainable drainage systems (SUDS) adoption manual. Anglian Water Services limited.

[https://www.anglianwater.co.uk/siteassets/developers/aw\\_suds\\_manual\\_aw\\_fp\\_web.pdf](https://www.anglianwater.co.uk/siteassets/developers/aw_suds_manual_aw_fp_web.pdf)

Rural Sustainable Drainage Systems (RSuDS) (2012) Environment Agency, UK.

[https://assets.publishing.service.gov.uk/government/uploads/system/uploads/attachment\\_data/file/291508/scho0612buwh-e-e.pdf](https://assets.publishing.service.gov.uk/government/uploads/system/uploads/attachment_data/file/291508/scho0612buwh-e-e.pdf)

Woods Ballard, B., Wilson, S., Udale-Clarke, H., Illman, S., Scott T., Ashley, R. and Kellagher, R. (2015) The SuDS Manual. Department for Environment Food and Rural Affairs.

[https://www.susdrain.org/resources/SuDS\\_Manual.html](https://www.susdrain.org/resources/SuDS_Manual.html)



FACT SHEET: FILTER STRIPS	
DESCRIPTION	Filter strips are gently sloping, vegetated strips of land that slowly convey and infiltrate runoff as overland sheet flow. They generally provide the first stage of rainwater management
FUNCTION	Runoff flows as a sheet across the filter strip slowing the flow of water and intercepting silt and pollution during its infiltration into the ground
SITE AND SELECTION CRITERIA	<ul style="list-style-type: none"><li>• Filter strips should to be located immediately adjacent to their drainage area to accept overland sheet</li><li>• Require well-drained ground</li><li>• Suitable for small drainage areas (up to 2 hectares)</li></ul>
CLEANING PERFORMANCE	Good in treating low polluted runoffs and removing silt
DIMENSIONING	<ul style="list-style-type: none"><li>• Dimensioning is approx. 10% of the connected surfaces</li><li>• It is recommended at least 1 m length of filter strip for every 6 m length of contributing drainage area (CIRIA, 2007)</li><li>• Appropriate slope for vegetated filter strip is 2 - 5%. Steeper slopes bring a risk of erosion and channelling of flows, while ponding may occur on shallower slopes</li><li>• Filter strips are designed to be permeable, although due to the low residence time there is likely to be little infiltration</li><li>• Limiting design factor is the length of flow directed to filter strip</li><li>• Filter strips should be a minimum of 6 m wide. Wider filter strips are required for steeper slopes, since velocities are likely to be higher</li><li>• The maximum upstream drainage length to a filter strip should not exceed 50 m (CIRIA, 2007)</li></ul>
APPLICATION AREAS	<ul style="list-style-type: none"><li>• Generally used as the first stage of a SUDS train, feeding, for example, into a swale or pond</li><li>• They are best suited to treating runoff from relatively small drainage areas such as car park, road surface, roof downpipe or a small field</li><li>▫ Filter strips are often integrated into the surrounding land use, such as public open space or road verges</li></ul>
BENEFITS	<ul style="list-style-type: none"><li>• Effective pre-treatment measure</li><li>• Encourages evaporation</li><li>• Provide good water quality treatment</li><li>• Provide filtration and sedimentation of suspended solids</li><li>• Can be easily integrated into landscaping</li><li>• Provide aesthetic benefits</li><li>• Easy to construct and low construction costs</li><li>• A robust system</li></ul>



## Thematic Catalogue 2 - ANNEX

LIMITATIONS	<ul style="list-style-type: none"><li>• Not suitable for steep sites</li><li>• Limited contribution to groundwater recharge due to the short residence time</li><li>• Low flood risk reduction</li><li>• No significant storage potential</li><li>• Soil compaction reduces effectiveness</li></ul>
COMBINATION POSSIBILITIES	As upstream pre-treatment system to other SUDS measures such as swales and infiltration trenches or as a single measure to treat rainwater
MAINTENANCE	Cost effective. Regular inspection and maintenance is important for effective operation. Regular maintenance includes litter and debris removal and grass cutting. Less frequent maintenance activities include: re-seeding areas of poor vegetation growth, repair of eroded or damaged areas and removal of sediment and other pollutants
COSTS	Capital costs vary considerably depending on the design, density and variety of vegetation and use of substrate materials such as gravel to increase effectiveness. Maintenance costs also vary considerably depending on their design



FACT SHEET: GREEN ROOFS	
DESCRIPTION	Roof covered with grass or plants growing on natural layered materials, to be used on terraces, roofs and horizontal surfaces. The vegetation helps trap pollutants and reduce the velocity of the stormwater runoff
FUNCTION	Green roofs mitigate urban heat island effect and help controlling inside building temperature. Slowdown of surface runoff and subsequent use of water for plants irrigation
SITE AND SELECTION CRITERIA	<ul style="list-style-type: none"> <li>• Suitable for buildings and infrastructures with correct floor payload</li> <li>• Suitable for sites which are both flat or sloping</li> <li>• Best used in urban areas</li> </ul>
CLEANING PERFORMANCE	Good and natural biological cleaning performance due to passage through the layered soil. Provide a medium water quality treatment. Grasses and perennial plants and shrubs can help absorb air pollution
DIMENSIONING	<ul style="list-style-type: none"> <li>• Lawn, meadow, grasses, herbs, perennial, sedum, shrubs, trees</li> <li>• Irrigation system</li> <li>• Extensive soil mix</li> <li>• Intensive soil mix</li> <li>• Separation fabric</li> <li>• Granular drainage or drainage plates</li> <li>• Protection mat / waterproof membrane</li> <li>• Extensive: minimum 8 cm, weight 90 - 180 kg/m<sup>2</sup></li> <li>• Intensive: minimum 20 cm, weight &gt; 180 kg/m<sup>2</sup></li> </ul>
APPLICATION AREAS	<ul style="list-style-type: none"> <li>• Widely applicable on residential, commercial and industrial sites, where concrete, metallic or asphalt surfaces are mostly used</li> <li>• For small or wide areas, very flexible system</li> <li>• Suitable for public and private buildings</li> </ul>
BENEFITS	<ul style="list-style-type: none"> <li>• Provide good removal of pollutants with a clever choice of plants</li> <li>• Reduce runoff rates and volumes on existing drainage system</li> <li>• Easy maintenance</li> <li>• Perfect to integrate new and existing buildings into landscape and public open spaces</li> <li>• Endless vegetation and design choices</li> <li>• Provide habitat for pollinators and enhance biodiversity and natural landscape</li> <li>• Increase aesthetics and value of buildings and urban areas</li> <li>• Increase thermal insulation in winter and summer time</li> <li>• Promote evapotranspiration</li> </ul>



## Thematic Catalogue 2 - ANNEX

LIMITATIONS	<ul style="list-style-type: none"> <li>• Low payload of existing roof</li> <li>• Steeply sloping roof</li> <li>• Accessible or not accessible roof (different technical solutions)</li> </ul>
COMBINATION POSSIBILITIES	With rainwater harvesting or recycled greywater; with green facades
MAINTENANCE	Medium or minimal maintenance requirements depending on plants choice. If properly done and regularly maintained, green roofs can last indefinitely. Maintenance objectives include maintaining a dense and healthy grass/plants cover. Other maintenance activities include periodic weed control
COSTS	<p>A medium/high-cost technology. Capital and maintenance costs can be variable depending on green design, plants choice and roof support variability</p> <p>Maintenance costs will vary depending on green design and type of vegetation and include re-establishing the plants, inspections and removal of weeds as required</p>

### PERFORMANCE

Peak flow reduction	High
Volume reduction	Medium
Slow runoff	High
Retention of suspended solids	High
Water quality treatment	Medium
Water storage	Medium
Groundwater recharge	Low
Biodiversity	High
Amenity potential	High

## References

European Federation Green Roofs & Walls.

<https://efb-greenroof.eu/>

Green Roof Technology.

<http://www.greenrooftechnology.com/greenroof-system>

Optigrün.

<https://www.optigruen.de/produkte/>



FACT SHEET: GREEN WALLS/FACADES	
DESCRIPTION	Greening of building facade with ground or system-bound climbing plants with the help of support structures and irrigation with rainwater. Ground-bound vegetation use climbing plants such as Virginia Creeper, Ivy, or climbing Hortensia which are planted in the earth, while system-bound plantings grow in planters, hanging buckets or other modular design which are irrigated and maintained
FUNCTION	Use plants to reduce runoff peak flows, increase evapotranspiration and improve urban climate, also for cooling of buildings as well as an architectural design element
SITE AND SELECTION CRITERIA	<ul style="list-style-type: none"> <li>• Little space requirement</li> <li>• Primary plant requirements for light, soil and climate are important for all facade greening and this has to be ensured all year round</li> <li>• Require professional plant selection and a suitable and reliable greening technology</li> <li>• Clean rainwater is required with a pH &lt; 7</li> </ul>
CLEANING PERFORMANCE	Good and natural biological cleaning performance due to passage through the layered soil. Provide a medium water quality treatment. Good contribution to air pollution reduction due to uptake of air pollutants by plants
DIMENSIONING	<ul style="list-style-type: none"> <li>• Major system elements include plants, a growing medium (substrate), structures that support and attach plants to the facade and an irrigation system (rainwater as a water source)</li> <li>• Design parameter: 0.5 - 0.8 l/m<sup>2</sup>. d for a green facade surface, depending on exposure and plant species</li> <li>• Choice of plants is crucial for success</li> <li>• It is recommended to combine irrigation with continuous monitoring of the water consumption</li> </ul>
APPLICATION AREAS	Widely applicable for all types of buildings
BENEFITS	<ul style="list-style-type: none"> <li>• Reduce runoff rates and volumes</li> <li>• Increase thermal insulation in winter and summer time</li> <li>• Promote evapotranspiration</li> <li>• Increase energy efficiency of buildings</li> <li>• Reduce heat island effects</li> <li>• Protect buildings from solar radiation and excess heat</li> <li>• Reduce air pollution through plant uptake of fine particulate matter</li> <li>• Promote noise reduction</li> <li>• Increase open space quality and biological diversity</li> <li>• Increase aesthetics and value of buildings in urban areas</li> </ul>



## Thematic Catalogue 2 - ANNEX

LIMITATIONS	High costs for investment, operation and maintenance
COMBINATION POSSIBILITIES	With greywater recycling systems in buildings for irrigation purposes
MAINTENANCE	<p>Regular maintenance and care of the irrigation technology and vegetation is required</p> <p>Ground-bound plantings: to be carried out 1-2 times a year including pruning, weeding in climbing aids, keeping certain parts of the building free, removing dead plant parts and, if necessary, fertilising and pest control</p> <p>System-bound plantings: to be carried out 5-10 times a year and include maintenance measures such as pruning, keeping certain parts of buildings free, replacing failed plants, maintenance of the water and nutrient supply system, frost protection of the irrigation system as well as fertilisation and pest control</p> <p>With climbing plants, the building need to be inspected annually and all roots, tendrils, twining stems and other plant parts must be removed from windows and gutters to prevent damage</p>
COSTS	Investment, operation and maintenance costs are comparatively high, especially for system-bound facade greening. Consumption of resources is low, especially for ground-based greenings

### PERFORMANCE

Peak flow reduction	Medium
Volume reduction	Medium
Slow runoff	Medium
Retention of suspended solids	High
Water quality treatment	High
Water storage	Medium
Groundwater recharge	Low
Biodiversity	High
Amenity potential	High

## References

Hermj M., Schauvliege M. & Tijssens G. (2005) Groenbeheer - een verhaal met toekomst; Velt i.s.m. afdeling Bos & Groen, Berchem.

Köhler (2012) ((Hsg.) Handbuch Bauwerksbegrünung - Planung, Konstruktion, Ausführung. Verlagsgesellschaft Rudolf Müller, Köln.

SenStadt (2010) Konzepte der Regenwasserbewirtschaftung: Gebäudebegrünung, Gebäudekühlung. Leitfaden für Planung, Bau, Betrieb und Wartung. Senatsverwaltung für Stadtentwicklung, Berlin. [http://www.gebaeudekuehlung.de/SenStadt\\_Regenwasser\\_dt\\_gross.pdf](http://www.gebaeudekuehlung.de/SenStadt_Regenwasser_dt_gross.pdf)





FACT SHEET: INFILTRATION BASIN	
DESCRIPTION	An infiltration basin is a natural or constructed shallow, vegetated depression which temporarily stores and infiltrates stormwater runoff into the surrounding naturally permeable soil over several days. They generally collect surface water runoffs from small areas and are usually dry except in periods of heavy rainfall
FUNCTION	Peak discharge control, storage, treatment and infiltration of the rainwater over several days. They may serve other functions such as recreation
SITE AND SELECTION CRITERIA	<ul style="list-style-type: none"><li>• Infiltration basins are easy to integrate into a site and in public open spaces</li><li>• They should not be sited on unstable ground and ground stability should be verified prior to construction</li><li>• Require a large area which is relatively flat</li><li>• Pre-treatment (e.g. filter strip or swale ) is essential to intercept silt and pollution and prevent clogging of the surface</li><li>• Land slopes should be less than 20%</li></ul>
CLEANING PERFORMANCE	High cleaning performance in conjunction with pre-treatment measures. Very effective at pollutant removal
DIMENSIONING	<ul style="list-style-type: none"><li>• In general, infiltration basins are designed to treat small drainage areas, typically covering a number of properties. They are typically used to serve drainage areas up to 20 hectares</li><li>• They should be designed such that 85% of the annual runoff volume is captured</li><li>• They should half empty within 24 h to avoid stress on vegetation</li><li>• Maximum storage depth should be limited to 0.8 m to reduce effects of water pressure on vegetation</li><li>• For safety reasons, slide slopes should be 1:3 maximum</li><li>• An overflow should be provided for larger storm events</li></ul>
APPLICATION AREAS	<ul style="list-style-type: none"><li>• For residential, commercial and industrial areas: urban limited</li><li>• Infiltration basins can be incorporated into new developments</li><li>• Ideal for use as playing fields, recreational areas or public open space</li></ul>
BENEFITS	<ul style="list-style-type: none"><li>• Control peak discharges</li><li>• Reduce runoff rates and volumes</li><li>• Provide good water quality treatment</li><li>• Contribute to groundwater recharge</li><li>• Enhance evapotranspiration in urban areas</li><li>• Provide habitat for wildlife</li><li>• Enhance natural landscape</li><li>• Simple and cost-effective to construct</li></ul>



## Thematic Catalogue 2 - ANNEX

LIMITATIONS	<ul style="list-style-type: none"> <li>• Infiltration basins are relatively high land-take measures</li> <li>• They have potentially high failure rates due to improper siting, poor design and lack of maintenance, especially if appropriate pre-treatment is not incorporated</li> <li>• Clogging risk in areas with high sediment load</li> <li>• Risk of permanent standing water in low permeable soils or if water table is too high</li> </ul>
COMBINATION POSSIBILITIES	With pre-treatment measures such as filter strips and swales
MAINTENANCE	<ul style="list-style-type: none"> <li>• Low maintenance. Monthly inspections include mowing, occasional sediment removal from any pre-treatment measure, annual repair of damaged vegetation, scarification and spiking and sediment removal as required (typically every 5 years)</li> </ul>
COSTS	A low-cost measure. The construction costs can vary greatly depending on the configuration, location, site-specific conditions, etc.

### PERFORMANCE

Peak flow reduction	High
Volume reduction	High
Slow runoff	High
Retention of suspended solids	High
Water quality treatment	Medium/High
Water storage	High
Groundwater recharge	Medium
Biodiversity	Medium
Amenity potential	Medium

## References

Anglian Water. Towards sustainable water stewardship. Sustainable drainage systems (SUDS) adoption manual. Anglian Water Services limited.

[https://www.anglianwater.co.uk/siteassets/developers/aw\\_suds\\_manual\\_aw\\_fp\\_web.pdf](https://www.anglianwater.co.uk/siteassets/developers/aw_suds_manual_aw_fp_web.pdf)

NWRM. Natural Water Retention Measures (NWRM). EU Directorate General Environment.

<http://nwrn.eu/measure/infiltration-basins>

Woods Ballard, B., Wilson, S., Udale-Clarke, H., Illman, S., Scott T., Ashley, R. and Kellagher, R. (2015) The SuDS Manual. Department for Environment, Food and Rural Affairs. CIRIA 2015.

[https://www.susdrain.org/resources/SuDS\\_Manual.html](https://www.susdrain.org/resources/SuDS_Manual.html)



## Thematic Catalogue 2 - ANNEX

### FACT SHEET: RAIN GARDENS (BIORETENTION SYSTEMS)

DESCRIPTION	<p>A rain garden is a shallow depression that uses engineered topsoil and native vegetation to capture and naturally treat runoffs from hard surfaces such as roofs, parking lots and driveways. A rain garden fills up with water and forms a temporary “pond” with high infiltration rates. Plant species should be tolerant to periods of intermittent flooding as well as drought conditions</p>
FUNCTION	<p>Collect, infiltrate and treat rainwater from small catchment areas such as residential neighbourhoods and car parks</p>
SITE AND SELECTION CRITERIA	<ul style="list-style-type: none"><li>• They should be located where runoff from impervious surfaces can be directed to them either by overland flow or by pipe</li><li>• Soil should be permeable</li></ul>
CLEANING PERFORMANCE	<p>High runoff cleaning potential due to passage through soil. Very effective at treating rainwater and removing pollutants</p>
DIMENSIONING	<ul style="list-style-type: none"><li>• The flat bottom area (base area) is used as the measure of the rain garden’s size. The area required for side slopes is added to the base area and this total area is considered for fitting a rain garden into a site</li><li>• The base area should be at least 5% of the impermeable catchment area draining to it</li><li>• Uniform layers of mulch, growing medium and drain rock cover the base area of a rain garden</li><li>• They usually require a drainage layer with perforated pipe and overflow to the sewer</li><li>• Water should drain within 24 h to anticipate the next storm</li><li>• Side slopes: maximum slope of 3:1</li><li>• Maximum ponded water depth: 15 cm</li><li>• Planting soil depth: 30 - 45 cm</li><li>• Mulch layer: approx. 8 cm</li></ul>
APPLICATION AREAS	<ul style="list-style-type: none"><li>• Widely applicable on residential, commercial and industrial sites</li><li>• Easy to incorporate into landscape and public open spaces</li><li>• Provide effective drainage from roof surfaces, sidewalks, roadsides and parking lots</li><li>• Relatively simple to design and maintain and can be fit into many different urban settings</li></ul>
BENEFITS	<ul style="list-style-type: none"><li>• Reduce runoff peak flow and volume</li><li>• Very effective at treating rainwater and removing pollutants</li><li>• Contribute significantly to evaporation and infiltration</li><li>• Design variability and flexibility</li><li>• Can increase the value of a property</li></ul>



## Thematic Catalogue 2 - ANNEX

LIMITATIONS	<ul style="list-style-type: none"> <li>• Most rain gardens are relatively small, since construction and maintenance of large rain gardens becomes difficult</li> <li>• They should receive clean runoff</li> </ul>
COMBINATION POSSIBILITIES	In combination with pre-treatment measures such as filter strips or swales or with rainwater harvesting systems, where cistern overflow can be connected to the rain garden
MAINTENANCE	<p>Rain gardens require routine maintenance. They should be regularly checked for blockages and litter and excess soil removed. Clearing of inlets, outlets and overflows, cutting back, trimming and general landscape care</p> <p>Occasional tasks as required: removal of silt from pre-treatment structure; replace the mulch every 3 years. Remedial work includes: level reinstatement due to erosion or damage and repair and replacement of inlets, outlets or overflow structures as required</p> <p>Rain garden plantings require care and watering until they are established, generally the first 1-2 years after construction</p>
COSTS	A cost-effective measure to control rainwater runoffs. Costs depend on several factors including size, location, soil conditions, design and type of plants used. Rain gardens which require drainage are generally more expensive than rain gardens which use the soil as sole infiltration medium

### PERFORMANCE

Peak flow reduction	High
Volume reduction	High
Slow runoff	Medium
Retention of suspended solids	High
Water quality treatment	High
Water storage	High
Groundwater recharge	High
Biodiversity	Medium
Amenity potential	Medium

## References

Bray, B., Gedge, D., Grant, G and Leuthvilay, L. Rain Garden Guide. Thames Water, UK.  
<https://raingardens.info/>

NWRM. Natural Water Retention Measures (NWRM). EU Directorate General Environment.  
<http://nwrn.eu/measure/rain-gardens>

Rain Garden Alliance. <http://raingardenalliance.org/what/faqs>



FACT SHEET: RAINWATER HARVESTING (RWH)	
DESCRIPTION	Rainwater from roofs and other impermeable surfaces is diverted and collected in rainwater barrels or cisterns serving as a potable or non-potable water source. A mains backup system ensures water supply during dry periods
FUNCTION	Source control and attenuation of runoff, storage and treatment of the rainwater. Augmentation of the water supply
SITE AND SELECTION CRITERIA	<ul style="list-style-type: none"> <li>• Low polluted and smooth roof surfaces are preferred</li> <li>• Cisterns located above ground are easier to handle and maintain</li> <li>• Cistern overflow should be preferably connected to an onsite infiltration system instead of its diversion into sewer</li> </ul>
CLEANING PERFORMANCE	A high cleaning performance through the use of specific sieves and filters and a regular system maintenance
DIMENSIONING	<ul style="list-style-type: none"> <li>• Sizing of a RWH system is simply made by balancing the amount of rainwater which can be collected from a specific surface area with the household water demand</li> <li>• For private homes and dwellings an estimation is usually adequate. A rough guide value would be to provide 1000 litres of storage volume per 20 m<sup>2</sup> of runoff surface, or to dimension the storage tank such that 3 - 4 weeks of drought can be bridged</li> <li>• For larger systems, a simulation of the rainfall data (data of the last 20 years, daily/monthly) and water consumption data using a computer model is necessary</li> </ul>
APPLICATION AREAS	<ul style="list-style-type: none"> <li>• Widely applicable in single-family houses, residential, commercial and industrial buildings</li> <li>• In new and renovated buildings</li> <li>• As potable water following proper treatment</li> <li>• For indoor and outdoor applications to replace drinking water for non-potable uses such as toilet flushing, cleaning, laundry, irrigation, firefighting, cooling towers or as process water in industry</li> </ul>
BENEFITS	<ul style="list-style-type: none"> <li>• Reduce runoff rate and volume</li> <li>• Provide a reliable and renewable source of water</li> <li>• Reduced demand on drinking water resources and groundwater extraction</li> <li>• Savings in the amounts of detergents used for laundry due to the softness of rainwater</li> <li>• Lower water bills</li> <li>• Lower energy costs for pumping and treating water</li> <li>• Reduced greenhouse gas emissions and air pollution</li> <li>• Increase autarchy (self-sufficiency) in dry periods</li> <li>• Enhance water conservation</li> </ul>



## Thematic Catalogue 2 - ANNEX

LIMITATIONS	<ul style="list-style-type: none"><li>• In existing buildings, only feasible following renovation and dual pipe system installation</li><li>• Roof material can impact the end use of the collected water</li></ul>
COMBINATION POSSIBILITIES	Connection with downstream infiltration systems such as a swale or trench for discharge of overflow
MAINTENANCE	Regular cleaning of the catchment, collection and distribution systems. Leaves and other debris should be removed frequently from roof gutters, downpipes and fine-mesh gutter covers to reduce debris and sediment deposits into the cistern (cleaning 2-3 times a year). Filters should be cleaned 1-2 times a year depending on the pollutant load. A visual inspection of the tank is recommended once a year and excessive sediment should be removed as required
COSTS	The total construction costs for a one-family house lie approx. between 2,500 to 5,000 € depending on the amount of work involved as well as the size of the storage tank and product quality. Maintenance costs amount to approx. 100 € per year.

### PERFORMANCE

Peak flow reduction	Medium
Volume reduction	Medium
Slow runoff	Medium
Retention of suspended solids	Medium
Water quality treatment	High
Water storage	High
Groundwater recharge	Low
Biodiversity	Good
Amenity potential	Good

## References

DIN EN 16941-1 (2018) On-site non-potable water systems - Part 1: Systems for the use of rainwater. Beuth Verlag

DIN 1989-100 (2020) Rainwater harvesting systems - Part 100: Regulations in connection with DIN EN 16941-1(Draft version)

fbr-Hinweisblatt H 101 (2016) Kombination der Regenwassernutzung mit der Regenwasserversickerung. Hrsg.: fbr. DIN-A 4, 32 Seiten, ISBN: 978-3-9811727-6-8



FACT SHEET: RETENTION PONDS	
DESCRIPTION	Retention ponds are wet ponds designed to permanently retain some water at all times and provide temporary storage of runoff
FUNCTION	Rainwater is stored temporarily and released slowly once risk of flooding has passed, thus reducing the peak flow during heavy rains
SITE AND SELECTION CRITERIA	<ul style="list-style-type: none"> <li>• Ponds should be located at the end of a management train to ensure that clean water and controlled flows enter the pond</li> <li>• The area required for a retention pond is generally 1 - 3% of its drainage area</li> <li>• Soil below pond needs to be sufficiently impermeable to stop the water from drying out</li> <li>• An adequate source of inflow is required to maintain the permanent water surface</li> </ul>
CLEANING PERFORMANCE	High cleaning capacity of runoff pollutants as a result of biological degradation, plant adsorption and sedimentation processes
DIMENSIONING	<ul style="list-style-type: none"> <li>• Retention ponds usually have irregular shapes with islands and bars which are designed with variable bed depths</li> <li>• They should be sized to treat the water quality volume and, if necessary, to mitigate the peak rates for larger rainfall events</li> <li>• Liners may be required to retain a permanent volume of water in the pond</li> <li>• They should include one or more forebays to capture coarse sediment, prevent excessive sediment accumulation, minimize erosion by inflow and ease maintenance</li> <li>• The depth of the permanent pool should be between 1.2 m and 1.8 m; deeper pools may be subject to stratification and anoxic conditions</li> <li>• Side slopes should not be steeper than 1:3 to ensure public safety and maintenance access</li> <li>• Residence time of at least 20 days is recommended to remove pollutants effectively</li> </ul>
APPLICATION AREAS	<ul style="list-style-type: none"> <li>• Primarily used to improve the quality of urban runoff from roads, parking lots, residential, industrial and commercial areas</li> <li>• Effective at storing runoff from small to medium drainage areas</li> <li>• Can be used in series with other SUDS features which reduce the sediment load such as vegetated filter strips and swales</li> </ul>
BENEFITS	<ul style="list-style-type: none"> <li>• Reduce peak runoff through storage and controlled outflow release, thus reducing flood risks</li> <li>• Provide high quality treatment and filtration of pollutants</li> <li>• Provide cost-effective additional storage capacity</li> <li>• High potential ecological, aesthetic and amenity benefits</li> <li>• Long lifespan</li> </ul>



## Thematic Catalogue 2 - ANNEX

LIMITATIONS	<ul style="list-style-type: none"> <li>• No reduction in runoff volume as no infiltration takes place</li> <li>• Should receive silt-free runoff (pre-treatment is necessary)</li> <li>• Anaerobic conditions may occur in the absence of regular inflow</li> <li>• May not be suitable for steep sloping sites, due to requirement for high embankments</li> <li>• High land-take measure limiting land use in high density areas</li> </ul>
COMBINATION POSSIBILITIES	Combination with upstream measures such as smaller detention basins and swales, which offer primary treatment
MAINTENANCE	Regular inspection and maintenance are important for effective operation, such as litter and debris removal, vegetation maintenance, inlet/outlet inspection and maintenance and sediment removal from forebay
COSTS	<p>Low maintenance costs: annual inspections, monthly mowing of side slopes, annual clearing of banks and plant management, removal of sediment from sediment trap every 3 - 7 years; removal of sediment in main pond every 20 years</p> <p>As a high land-take measure, high costs arise for the construction of retention ponds and the value of the land. However, the overall marginal costs are low due to long lifespan (over 20 years)</p>

### PERFORMANCE

Peak flow reduction	High
Volume reduction	Low
Slow runoff	High
Retention of suspended solids	Medium
Water quality treatment	High
Water storage	High
Groundwater recharge	None to low
Biodiversity	High
Amenity potential	High

## References

Anglian Water. Towards sustainable water stewardship. Sustainable drainage systems (SUDS) adoption manual. Anglian Water Services Limited.

[https://www.anglianwater.co.uk/siteassets/developers/aw\\_suds\\_manual\\_aw\\_fp\\_web.pdf](https://www.anglianwater.co.uk/siteassets/developers/aw_suds_manual_aw_fp_web.pdf)

Rural Sustainable Drainage Systems (RSuDS) (2012) Environment Agency, UK.

[https://assets.publishing.service.gov.uk/government/uploads/system/uploads/attachment\\_data/file/291508/scho0612buwh-e-e.pdf](https://assets.publishing.service.gov.uk/government/uploads/system/uploads/attachment_data/file/291508/scho0612buwh-e-e.pdf)

Woods Ballard, B., Wilson, S., Udale-Clarke, H., Illman, S., Scott T., Ashley, R. and Kellagher, R. (2015) The SuDS Manual. Department for Environment Food and Rural Affairs. [https://www.susdrain.org/resources/SuDS\\_Manual.html](https://www.susdrain.org/resources/SuDS_Manual.html)





FACT SHEET: SURFACE FLOW CONSTRUCTED WETLANDS	
DESCRIPTION	Constructed wetlands (CWs) are vegetated/marshy systems which permanently retain a certain volume of water. They are ponds that include shallow areas which allow for plant growth. CWs attenuate the peak of runoff of surface waters and the vegetation provides for their treatment
FUNCTION	CWs provide a temporary storage of runoff and reduce flow rates allowing sedimentation. A considerable share of nutrients is removed by sedimentation and biological activity due to the water-vegetation-soil interaction
SITE AND SELECTION CRITERIA	<ul style="list-style-type: none"><li>• Suitable for residential areas</li><li>• Suitable for sites which are not steeply sloping with stable ground</li><li>• If not lined, soil beneath the CWs should be sufficiently impermeable to maintain saturated conditions and avoid drying out</li><li>• Not too close to the groundwater table to avoid contamination</li></ul>
CLEANING PERFORMANCE	Good water quality treatment due to sedimentation, filtration, adsorption, microbial decomposition and plant uptake Extensive surface flow wetlands are also used in US as a single stage for the treatment of combined sewer overflow
DIMENSIONING	<ul style="list-style-type: none"><li>• Total surface area of CW should be about 1 - 2% of the area that drains into it</li><li>• The ratio of flow path length to width should be at least 3:1 (ideally 4:1 or 5:1)</li><li>• Maximum depth should not exceed 2 m</li><li>• Maximum depth of temporary storage above permanent pool should not exceed 0.5 m</li><li>• Gentle slopes are suggested, i.e. equal to 1:3, 1:4</li><li>• Wetland topsoil depth: 400 - 450 mm for shrubs and herbaceous, 100 - 150 mm for grass/wildflower seeding</li><li>• Layer of subsoil or gravel typically 50 - 150 mm depth</li></ul>
APPLICATION AREAS	<ul style="list-style-type: none"><li>• Residential and non-residential areas</li><li>• Large areas of open space, but small CWs can also be integrated into urban settings</li><li>• New developments and re-developments</li></ul>
BENEFITS	<ul style="list-style-type: none"><li>• Provide good removal of pollutants</li><li>• Peak flow reduction</li><li>• Reduce runoff rates</li><li>• Increase in biodiversity</li><li>• Increase aesthetics and value of site</li></ul>



## Thematic Catalogue 2 - ANNEX

LIMITATIONS	<ul style="list-style-type: none"> <li>• Risk of sediment re-entrainment, if the CW is too shallow near the outlet</li> <li>• Risk of algal blooms in summer months</li> <li>• Risk of drying out in summer months</li> <li>• Low temperature decreases biological activity</li> <li>• More suited to peri-urban area, where larger areas for implementation are available</li> </ul>
COMBINATION POSSIBILITIES	<p>With a sediment forebay to allow sedimentation and reduce the inlet flow</p> <p>With a subsurface flow wetland system to increase treatment performance</p>
MAINTENANCE	<p>Regular maintenance and inspection are important for the treatment performance of CWs</p> <p>Monthly litter and debris removal, silt removal from forebay once every 1 - 5 years</p>
COSTS	<p>Variable capital costs, depending on location, site variability and plant choice</p> <p>Low operation and maintenance costs</p>

### PERFORMANCE

Peak flow reduction	High
Volume reduction	High
Slow runoff	High
Retention of suspended solids	High
Water quality treatment	Medium
Water storage	High
Groundwater recharge	None
Biodiversity	High
Amenity potential	High

## References

Kadlec, Robert & Wallace, Scott (2009) Treatment Wetlands. 10.1201/9781420012514.

Rizzo, A., Tondera, K., Pálffy, T.G., Dittmer, U., Meyer, D., Schreiber, C., Zacharias, N., Ruppelt, J.P., Esser, D., Molle, P., Troesch, S., Masi F. (2020) Constructed wetlands for combined sewer overflow treatment: A state-of-the-art review. Science of The Total Environment, p.138618

Tondera, Katharina & Blecken, Godecke & CHAZARENC, FLORENT & Tanner, Chris (2018) Ecotechnologies for the Treatment of Variable Stormwater and Wastewater Flows. 10.1007/978-3-319-70013-7.

Woods Ballard, B., Wilson, S., Udale-Clarke, H., Illman, S., Scott T., Ashley, R. and Kellagher, R. (2015) The SuDS Manual. Department for Environment Food and Rural Affairs. CIRIA 2015.  
<https://www.susdrain.org/delivering-suds/using-suds/suds-components/filtration/filter-strips.html>



FACT SHEET: SUBSURFACE FLOW CONSTRUCTED WETLAND	
DESCRIPTION	<p>Subsurface flow constructed wetlands are wetland systems in which the stormwater flows through a porous media of selected size (typically sand or gravel)</p> <p>A well-known application of subsurface flow wetland for stormwater treatment is the so-called retention soil filter (RSF), which consists of sand as filter material (to which 20-30 vol.-% of CaCO<sub>3</sub> is added), a drainage layer consisting of gravel and drainage pipes installed below the filter body, treating rainwater before it is discharged into the receiving water body. RSF is sealed by a membrane to protect the soil layers below and groundwater from contamination. RSFs are planted with reeds to avoid clogging</p>
FUNCTION	Peak flow reduction and rainwater treatment by means of filtration, adsorption and biodegradation of pollutants the soil filters grown with reed plants
SITE AND SELECTION CRITERIA	Suitable for sites which are not steeply sloping with stable ground
CLEANING PERFORMANCE	<p>High cleaning capacity of pollutants as a result of biodegradation, plant adsorption and sedimentation processes. Provide a high water quality treatment</p> <p>Subsurface flow wetlands, including RSFs, can be also successfully applied for the treatment of combined sewer overflow, in which stormwater is mixed with sewage</p>
DIMENSIONING	<ul style="list-style-type: none"> <li>• Area requirement for RSF is approx. 2% of the connected impermeable drainage area</li> <li>• Overflow frequency of the filter: <math>n = 0.1/a</math> (with full-flow treatment); pre-relief via a separating structure in the inlet of the pre-stage</li> <li>• The filter's throttled flow rate is selected based on the treatment goal and lies typically between 0.01 and 0.05 l/s.m<sup>2</sup> filter surface</li> </ul>
APPLICATION AREAS	<ul style="list-style-type: none"> <li>• Subsurface flow wetlands are usually chosen when water quality is the main target, due to the high treatment efficiency</li> <li>• Large areas of open space, but small CWs can also be integrated into urban settings</li> <li>• New developments and re-developments</li> </ul>
BENEFITS	<ul style="list-style-type: none"> <li>• High removal of pollutants</li> <li>• Peak flow reduction</li> <li>• Increase the quality of open spaces</li> </ul>
LIMITATIONS	<ul style="list-style-type: none"> <li>• More suited to peri-urban areas, where larger areas for implementation are available</li> </ul>
COMBINATION POSSIBILITIES	<ul style="list-style-type: none"> <li>• Subsurface flow system can be combined with surface flow wetlands, especially if other side benefits are targeted (e.g. promote biodiversity, recreational site, volume reduction)</li> </ul>



## Thematic Catalogue 2 - ANNEX

MAINTENANCE	Regular maintenance and inspection are important for the treatment performance of CWs Cleaning of pre-treatment (e.g. grit removal, if used) once a year Reed harvesting (2 - 3 years after the start-up) and green maintenance once per year
COSTS	The consumption of resources and the costs (investment and operation) are comparatively low due to the large connected area Low maintenance costs

### PERFORMANCE

Peak flow reduction	High
Volume reduction	Low
Slow runoff	High
Retention of suspended solids	Medium
Water quality treatment	High
Water storage	Low
Groundwater recharge	None
Biodiversity	Medium
Amenity potential	Medium

## References

MUNLV 2015. Retentionsbodenfilter. Handbuch für Planung, Bau und Betrieb. Ministerium für Klimaschutz, Umwelt, Landwirtschaft, Natur- und Verbraucherschutz (MUNLV) des Landes Nordrhein-Westfalen. 2 Auflage.

[https://www.umwelt.nrw.de/fileadmin/redaktion/Broschueren/retentionbodenfilter\\_handbuch.pdf](https://www.umwelt.nrw.de/fileadmin/redaktion/Broschueren/retentionbodenfilter_handbuch.pdf)

KURAS. Concepts for urban rainwater management, drainage and sewage systems. Research project: 2013-2016. Funded by the German Federal Ministry of Education and Research under the funding measure "Smart and Multifunctional Infrastructural Systems for Sustainable Water Supply, Sanitation and Stormwater Management" (INIS).

[http://www.kuras-projekt.de/fileadmin/Dokumente\\_Verwaltung/pdf/Steckbrief\\_12\\_Retentionsbodenfilter.pdf](http://www.kuras-projekt.de/fileadmin/Dokumente_Verwaltung/pdf/Steckbrief_12_Retentionsbodenfilter.pdf)

Langergraber, G., Dotro, G., Nivala, J., Rizzo, A., & Stein, O. R. (Eds.) (2020) Wetland Technology: Practical Information on the Design and Application of Treatment Wetlands. IWA Publishing. <https://doi.org/10.2166/9781789060171>

Rizzo, A., Tondera, K., Pálffy, T.G., Dittmer, U., Meyer, D., Schreiber, C., Zacharias, N., Ruppelt, J.P., Esser, D., Molle, P., Troesch, S., Masi F. (2020) Constructed wetlands for combined sewer overflow treatment: A state-of-the-art review. Science of The Total Environment, p.138618



FACT SHEET: SWALE-TRENCH INFILTRATION	
DESCRIPTION	A combination of surface retention and cleaning of a vegetated swale and the underground retention of the stone-filled trench. Water passes through the top soil of the swale into a permeable trench zone, where water is either infiltrated into deeper layers or throttled to a surface water body or sewer. An overflow from swale directly into the trench can be constructed, when storage volume of swale is exhausted
FUNCTION	Peak flow reduction and runoff treatment through Infiltration, temporary underground storage, adsorption and biodegradation in underlying soil
SITE AND SELECTION CRITERIA	<ul style="list-style-type: none"> <li>• Suitable for sites where space is limited</li> <li>• Swale-trench systems have a lower space requirement than surface or swale infiltration, approx. 10 % of the catchment area</li> <li>• Suitable for sites with low soil permeability such as loamy soil (<math>K_f &lt; 10^{-6}</math> m/s)</li> </ul>
CLEANING PERFORMANCE	Provide good cleaning of the rainwater through passage into subsoil and gravel bed
DIMENSIONING	<ul style="list-style-type: none"> <li>• Topsoil layer (30 cm) and gravel layer (5 cm) between swale and infiltration trench</li> <li>• Trench as storage reservoir filled with gravel (grain size 16/32 mm) or plastic boxes and a drainpipe</li> <li>• Throttle shaft, with throttle element at the end of the drainpipe</li> <li>• During hydraulic peak loads an emergency overflow from the swale directly into the trench can relieve the pressure on swale</li> <li>• At the end of the trench drainpipe, a throttle device ensures the retarded discharge of rainwater in the trench into the rainwater sewer</li> <li>• Usually 50% infiltration rates are achieved, where 10 % of the rainwater evaporates and 40% are discharged at a throttled flow into the rainwater sewer</li> </ul> <p>Drainpipe should have a minimum diameter of 15 cm</p>
APPLICATION AREAS	<ul style="list-style-type: none"> <li>• Applicable on residential, commercial and industrial sites where space is limited</li> </ul>
BENEFITS	<ul style="list-style-type: none"> <li>• Control runoff peak flow and volume</li> <li>• Provide temporary storage of runoff</li> <li>• Provide good water treatment</li> <li>• Enhance groundwater recharge</li> <li>• Increased evaporation potential through vegetation</li> <li>• Improve quality of open spaces and site landscaping</li> </ul>



## Thematic Catalogue 2 - ANNEX

LIMITATIONS	<ul style="list-style-type: none"> <li>• Potential failure due to improper siting, design and lack of maintenance, especially if pre-treatment is not incorporated into design</li> <li>• Susceptible to clogging by sediment, if not well designed</li> <li>• Dependent on soil conditions, land use and groundwater depth, a risk of groundwater contamination may exist</li> </ul>
COMBINATION POSSIBILITIES	Possibility of coupling with rainwater harvesting systems
MAINTENANCE	Maintenance expenditure is similar to that of swales and trenches. It is important to keep infiltration surface and inlets clean from debris, sediment and other material. If the infiltration capacity drops, the grass should be scarified. Maintenance of the trench is low if adequate pre-treatment (sediment trap, filter strip) is considered. Shafts should be inspected against clogging in regular periods (at least once a year) and if needed cleaned and drainpipe system rinsed
COSTS	Resource consumption lies in the middle range, while investment costs are low

### PERFORMANCE

Peak flow reduction	High
Volume reduction	Medium
Slow runoff	Low
Retention of suspended solids	High
Water quality treatment	High
Water storage	Medium
Groundwater recharge	High
Biodiversity	Low
Amenity potential	Low

## References

Ingvertsen, S. T., Sommer, H., Cederkvist, K., Régent, Y., Jensen, M.B. and Magid, J. Infiltration and treatment of urban stormwater: how well do swale-trench systems work? NOVATECH 2010.  
<http://citeseerx.ist.psu.edu/viewdoc/download?doi=10.1.1.1005.3950&rep=rep1&type=pdf>

Sieker, H (2018) Planungshilfe für eine dezentrale Strassenentwässerung.  
<https://www.berlin.de/senuvk/umwelt/wasser/download/planungshilfe.pdf>



FACT SHEET: VEGETATED SWALES	
DESCRIPTION	Open, wide and shallow channels usually covered by grass and which convey stormwater from sealed surfaces, treat, filter and infiltrate it into the ground. The vegetation helps trap pollutants and reduce the velocity of the stormwater runoff
FUNCTION	Temporary storage of runoff and subsequent surface infiltration over the vegetated topsoil
SITE AND SELECTION CRITERIA	<ul style="list-style-type: none"> <li>• Suitable for areas where there is not enough space for surface infiltration</li> <li>• Swales are generally suited for small catchments with impermeable surfaces</li> <li>• Suitable for sites which are not flat or steeply sloping</li> <li>• Best used close to source</li> <li>• A good permeable soil is required: infiltration coefficient (kf) up to <math>1 \times 10^{-6}</math> m/s</li> </ul>
CLEANING PERFORMANCE	Good and natural biological cleaning performance due to passage through the subsoil. Provide a good water quality treatment
DIMENSIONING	<ul style="list-style-type: none"> <li>• Decisive parameter is the connected drainage area. As a rule of thumb, the total surface area of a swale should be about 10-20% of the area that drains into the swale</li> <li>• Maximum swale depth: 30 cm</li> <li>• Maximum slide slope 1:2</li> <li>• Vegetated swales should be designed with a bottom width of 0.5 - 2 m allowing for shallow flows and adequate water quality treatment</li> <li>▫ The design event runoff volumes should half empty within 24 h to avoid water impoundment</li> <li>• Longitudinal slopes between 1% and 4% are recommended</li> <li>• Topsoil with substrate (usually grass): &gt; 10 cm. For a good cleaning capacity approx. 30 cm are recommended</li> </ul>
APPLICATION AREAS	<ul style="list-style-type: none"> <li>• Widely applicable on residential, commercial and industrial sites, which due to limited space no surface infiltration is allowed</li> <li>• Especially applicable in good and moderately permeable underground</li> <li>• Provide effective drainage for roof runoffs, linear roads, sidewalks, highways and parking lots</li> </ul>
BENEFITS	<ul style="list-style-type: none"> <li>• Reduce peak flow to receiving water</li> <li>• Reduce runoff rates and volumes</li> <li>• Provide good removal of pollutants</li> <li>• Low maintenance and technical expenditure</li> <li>• Easy to integrate into landscape and public open spaces</li> <li>• Provide habitat for wildlife and enhance natural landscape</li> <li>• Increase aesthetics and value of site</li> </ul>



## Thematic Catalogue 2 - ANNEX

LIMITATIONS	<ul style="list-style-type: none"> <li>• Usage competition in dense urban developments, where space is limited</li> <li>• Generally remove pollutants during frequent small storm events; for larger storm events this may become impractical</li> <li>• Care required to avoid erosion</li> </ul>
COMBINATION POSSIBILITIES	With pre-treatment measures such as filter strips. For subsoils with low infiltration potential, a combination with an infiltration trench system is possible
MAINTENANCE	Minimal maintenance requirements. If properly designed and regularly maintained, vegetated swales can last indefinitely. Maintenance objectives include keeping up the hydraulic and removal efficiency and maintaining a dense and healthy grass cover. Other maintenance activities include periodic mowing, weed control, clearing of litter/debris and blockages
COSTS	A low-cost technology. Capital and maintenance costs can be variable depending on swale design and site variability

### PERFORMANCE

Peak flow reduction	High
Volume reduction	Medium
Slow runoff	High
Retention of suspended solids	High
Water quality treatment	Medium
Water storage	Low
Groundwater recharge	Medium
Biodiversity	Medium
Amenity potential	Medium

## References

Anglian Water. Towards sustainable water stewardship. Sustainable drainage systems (SUDS) adoption manual. Anglian Water Services limited.

[https://www.anglianwater.co.uk/siteassets/developers/aw\\_suds\\_manual\\_aw\\_fp\\_web.pdf](https://www.anglianwater.co.uk/siteassets/developers/aw_suds_manual_aw_fp_web.pdf)

NWRM. Natural Water Retention Measures (NWRM). EU Directorate General Environment.

<http://nwrn.eu/>

Sieker - Die Regenwasserexperten: <https://www.sieker.de/de/home.html>

Woods Ballard, B., Wilson, S., Udale-Clarke, H., Illman, S., Scott T., Ashley, R. and Kellagher, R. (2015) The SuDS Manual. Department for Environment, Food and Rural Affairs. CIRIA 2015.

[https://www.susdrain.org/resources/SuDS\\_Manual.html](https://www.susdrain.org/resources/SuDS_Manual.html)





## Thematic Catalogue 2 - ANNEX

FACT SHEET: PERMEABLE PAVINGS	
DESCRIPTION	Surface infiltration through a permeable or porous paving layer allowing rainwater to infiltrate into the ground over several layers of different fine-grained materials. Most commonly used material include permeable concrete, porous asphalt, paving stones and grass-concrete blocks
FUNCTION	Reduce runoff peak rate through infiltration and temporary storage of the rainwater before seepage into the underground
SITE AND SELECTION CRITERIA	<ul style="list-style-type: none"> <li>• Most effective when applied at the start of a SUDS train</li> <li>• Siting should take into account the proximity of existing features, such as private water supplies and open channels</li> <li>• Different types of permeable pavings vary in their ease of construction and installation costs</li> </ul>
CLEANING PERFORMANCE	Moderate to high cleaning performance
DIMENSIONING	<ul style="list-style-type: none"> <li>• Design varies considerably depending on type of material used and whether infiltration is allowed on site. To increase the volume of runoff that can be directed to the pavers, they can be installed with a drainage pipe and a rock reservoir underneath</li> <li>• Hydraulic design must provide storage based on the relationship between rainfall and outflow during storm events</li> <li>• The drainage area of a permeable pavement is generally the area of the pavement itself, as it captures the rain which falls directly onto it, for example, a car park or a road</li> <li>• The drainage area leading to permeable pavings should not exceed twice the surface area of the final pavement surface</li> </ul>
APPLICATION AREAS	<ul style="list-style-type: none"> <li>• Most commonly used on roads, driveways, parking lots, walkways, tennis courts, playgrounds and street surfaces for light traffic</li> <li>• Increasingly used in urban areas where development sites are predominantly hardstanding, where impermeable paving can be replaced by permeable paving to promote infiltration</li> </ul>
BENEFITS	<ul style="list-style-type: none"> <li>• Control stormwater at source and reduce peak flow</li> <li>• Improve water quality by filtering pollutants during passage in the sub-soil layers</li> <li>• Provide temporary storage for peak rate control</li> <li>• Permeable paving generally provides the first stage of runoff management, capturing runoff directly from impermeable or low permeability areas. As such, no pre-treatment is required</li> <li>• Maintain access and durability for vehicles and foot traffic</li> <li>• No land acquisition is required, as the pervious pavement replaces an impermeable surface</li> </ul>



## Thematic Catalogue 2 - ANNEX

LIMITATIONS	<ul style="list-style-type: none"> <li>• Where there is concern of possible groundwater pollution, an impermeable membrane should be constructed and treated stormwater discharged into a suitable drainage system</li> <li>• Not recommended where soil permeability is low and groundwater table high (less than 1 m)</li> </ul>
COMBINATION POSSIBILITIES	Can be combined with an adjacent swale or infiltration basin
MAINTENANCE	Regular inspection and maintenance are important for effective operation, especially during and after heavy rainfall; monitoring of pavement for weed growth and sediment buildup; repair damaged slabs and sub-base lining. Cleaning of system once a year to prevent clogging and preserve the porosity of the material
COSTS	There is considerable variation in the capital cost, reflecting the range of design approaches and construction materials available. Permeable paving costs less on a lifecycle basis than traditional surfaces, with reduced maintenance costs (1 to 5 €/m <sup>2</sup> /year) outweighing increased capital costs. These vary considerably (40 to 90 €/m <sup>2</sup> ), depending on design approaches and construction materials. Use of recycled materials may significantly reduce costs

### PERFORMANCE

Peak flow reduction	High
Volume reduction	Medium
Slow runoff	High
Retention of suspended solids	Medium
Water quality treatment	Medium
Water storage	Medium
Groundwater recharge	Medium
Biodiversity	Low
Amenity potential	Low

## References

Dierkes, C. Lucke, T. and Helmreich, B. (2015) General Technical Approvals for Decentralised Sustainable Urban Drainage Systems (SUDS) - The Current Situation in Germany. Sustainability 2015, 7: 3031-3051.

Rural Sustainable Drainage Systems (RSuDS) (2012) Environment Agency, UK.

[https://assets.publishing.service.gov.uk/government/uploads/system/uploads/attachment\\_data/file/291508/scho0612buwh-e-e.pdf](https://assets.publishing.service.gov.uk/government/uploads/system/uploads/attachment_data/file/291508/scho0612buwh-e-e.pdf)

Woods Ballard, B., Wilson, S., Udale-Clarke, H., Illman, S., Scott T., Ashley, R. and Kellagher, R. (2015) The SuDS Manual. Department for Environment Food and Rural Affairs. CIRIA 2015.

[https://www.susdrain.org/resources/SuDS\\_Manual.html](https://www.susdrain.org/resources/SuDS_Manual.html)



Thematic Catalogue 3

# Smart governance tools fostering circular urban water usage



# Content

<b>1. INTRODUCTION</b>	<b>206</b>
<b>2. WATER PRICING SYSTEM</b>	<b>207</b>
2.1. WATER AND WASTEWATER TARIFFS	208
2.2. REGULATORY ENVIRONMENT AND MAIN STAKEHOLDERS	209
2.3. WATER AND WASTEWATER TARIFF DESIGN	210
2.3.1. Fixed Charge	211
2.3.2. Uniform Volumetric Tariff	212
2.3.3. Increasing Block Tariffs	212
2.3.4. Decreasing Block Tariffs	214
2.4. EXAMPLE: DESIGN OF A NEW TARIFF IN BOLOGNA BLUEAP	215
<b>3. WATER CONSERVATION PROGRAMS</b>	<b>218</b>
3.1. CHICAGO'S VOLUNTARY METER-SAVE PROGRAM	218
3.2. CO-DESIGN WITH CITIZENS - START PARK, PRATO - ITALY	219
3.3. A PARTICIPATORY MODELLING APPROACH FOR SUSTAINABLE URBAN WATER MANAGEMENT, EBBSFLEET GARDEN CITY, UK	220
<b>4. MONITORING THE WATER CYCLE</b>	<b>224</b>
4.1. SMART APPROACH TO MONITOR RAINWATER HARVESTING	225
4.2. WATER QUALITY OF RAINWATER HARVESTING SYSTEMS	226
4.3. TURNING SMART WATER METER DATA INTO USEFUL INFORMATION	227
4.4. FORECASTING DOMESTIC WATER CONSUMPTION FROM SMART METER READINGS	229



# Content

<b>5. INCENTIVES AND FINANCIAL SUPPORT (FOR RECYCLED WATER PROJECT &amp; CONSTRUCTION OF HARVESTING SYSTEMS)</b>	<b>231</b>
5.1. CLIMATE FINANCE: FINANCIAL AND ECONOMIC CONSIDERATIONS	231
5.1.1. Types of climate investments for water projects	233
5.1.2. Multilateral climate finance for water	233
5.1.3. National climate finance for water	235
5.2. FINANCIAL INSTRUMENTS FOR MUNICIPAL GOVERNMENTS	236
5.2.1. Tax and fees relief	236
5.2.2. Subsidies	237
5.2.3. Participatory budgets	238
5.3. ECONOMIC INCENTIVES FOR WATER CONSUMPTION REDUCTION: CASE STUDY OF THE CITY OF SÃO PAULO	239
<b>6. EDUCATION PROGRAMMES</b>	<b>241</b>
6.1. ENHANCING TERTIARY WATER EDUCATION AND PROFESSIONAL CAPABILITIES IN THE WATER SECTOR	241
6.2. ADDRESSING VOCATIONAL EDUCATION AND TRAINING OF WATER TECHNICIANS	242
6.3. WATER EDUCATION FOR CHILDREN AND YOUTH	242
6.4. PROMOTING AWARENESS OF WATER ISSUES THROUGH INFORMAL WATER EDUCATION	243
6.5. EDUCATION FOR TRANSBOUNDARY WATER COOPERATION AND GOVERNANCE	243
6.6. SMART DEVICES AND GAMIFICATION	244
<b>CONCLUSIONS</b>	<b>247</b>



# 1. Introduction

CWC aims at defining and introducing an innovative approach to the circular management of water resources. This approach, the Smart Water Governance, intends to foster the active involvement and engagement of the stakeholders and to make a good use of technological tools.

It is important to highlight that in a problem such as circular water management, if the stakeholders do not actively cooperate, fostering circularity is difficult or more likely impossible. Stakeholders experience, support, and collaboration is crucial. There are many actors involved, and in order to obtain good results it is necessary that everyone does carry out his/her own tasks. Furthermore, the active involvement of stakeholders in planning and managing is necessary to implement a multidisciplinary approach. Decision processes, roles and responsibilities must be transparent and shared. Stakeholders, including citizens, must receive proper engagement and tools for an active participation, according to their roles.

A Smart Water Governance approach might find barriers in an inadequate expertise of the decision-makers on this topic, in an often non-existent legislative framework, in a weak bottom-up impulse by citizens and in the interests of companies and lobbies.

Beyond their obvious utility in technical installations, technological tools can improve knowledge and communication, increase citizens' awareness and their ability to gather and share data. Smart monitoring tools can also improve the control on the project implementation and help in sharing transparently processes and results.

Although Smart Water Governance cannot be defined as a general set of rules and interventions, we have listed 5 areas of intervention that, properly deployed, can constitute elements of a Smart Water Governance.

The Smart Water Governance Catalogue defines for each area of intervention features, tools and characteristics to be taken into account while designing a specific Smart Water Governance for a specific location.

Each area of intervention refers to one or more CWC general goal:

1. Recycle and reuse wastewater
2. Increase efficiency in water use and distribution
3. Guarantee good quality of water bodies
4. Retain water as long as possible on site
5. Promote multiple water use and water sustainability
6. Preserve flow in water bodies

The catalogue refers to the categories of intervention that compose a Smart Water Governance:

1. Water pricing system
2. Water conservation programs
3. Monitoring Rainwater harvesting and Greywater: quantity and quality level
4. Incentives and Financial support (for recycled water project & construction of harvesting systems)
5. Education programmes

In the following chapters, a general overview of the state of the art for each category, including sources of information, is presented. For each category, the focus is on potential smart approach already in use or that can be suitable to improve the current state of the art, mainly taking advantage of new technologies and/or stakeholder involvement.



## 2. Water Pricing System

(Main source: Ricato Martina, Water Pricing, [sswm.info](http://sswm.info), 2019)

*“On 28 July 2010, through Resolution 64/292, the United Nations General Assembly explicitly recognized the human right to water and sanitation and acknowledged that clean drinking water and sanitation are essential to the realisation of all human rights. The Resolution calls upon States and international organisations to provide financial resources, help capacity-building and technology transfer to help countries, in particular developing countries, to provide safe, clean, accessible and affordable drinking water and sanitation for all.*

*In November 2002, the Committee on Economic, Social and Cultural Rights adopted General Comment No. 15 on the right to water. Article I.1 states that “The human right to water is indispensable for leading a life in human dignity. It is a prerequisite for the realization of other human rights”. Comment No. 15 also defined the right to water as the right of everyone to sufficient, safe, acceptable and physically accessible and affordable water for personal and domestic uses.”*

*Sources: Resolution A/RES/64/292. United Nations General Assembly, July 2010 General Comment No. 15. The right to water. UN Committee on Economic, Social and Cultural Rights, November 2002*

At the same time, extraction, sanitation and distribution of water are also costly activities.

In pricing water there is a need to balance these two aspects.

Pricing water fairly and equally is important to sustain and extend the water and sanitation system. In many countries, consumers don't pay enough to sustain water services. Revenue from water charges does not even cover operation and maintenance of water utilities, inhibiting investments for the infrastructure.

Water and wastewater tariffs determine the level of revenues that service providers receive from users in for the appropriate treatment, purification and distribution of freshwater, and the subsequent collection, treatment and discharge of wastewater.

Water pricing is an important economic instrument for improving water use efficiency, enhancing social equity and securing financial sustainability of water utilities and operators.

### Advantages

- Provides incentives for efficient water use and for water quality protection
- Charges send price signals to users to make them aware of the relationship between water use and water scarcity
- Pricing water provides funds that can be used for necessary infrastructure development and expansion
- Water pricing can favour in the medium-long term that water services be provided to all citizens at an affordable price

### Criticalities

- There is disagreement over the objectives of water pricing and tariff design
- Tariff setting is a political process quite controversial
- A transparent tariff setting process is not easy to obtain



- Tariff design is a complex process that needs high volume of data in order to be scientifically based
- A “scientifically optimal tariff” does not exist and some degree of subjectivity is always involved in fixing tariffs
- Water tariffs can be difficult to understand for consumer

### 2.1. Water and Wastewater Tariffs

A water tariff is the price assigned to water supplied by a public utility generally for both freshwater supply and wastewater treatment. The term is also often applied to wastewater tariffs. Water and wastewater tariffs determine the conditions of service and the monthly bills for water users in various categories and classes. Tariffs are often set by a regulatory agency for the appropriate catchment, purification and distribution of freshwater, and the subsequent collection, treatment and discharge of wastewater.

Wastewater tariffs can be a fixed percentage of water tariffs, or can be set separately. Water charges often contain some elements to address poverty. Connexion fees to a network, or installation costs for pumps are generally charged separately (Cardone and Fonseca 2004).

Tariff setting practises vary widely around the world, and there is no consensus on which tariff structure best balances the objectives of the utility, consumers, and society (Whittington 2002).

#### Why Setting a Tariff on Water?

(Main source Rogers et al. 2001)

Often, consumers pay, for the water and sanitation services, less than the cost of the service itself. People are not aware of the real costs of providing water and sanitation because these have been historically heavily subsidised from governments. This is because water is a social good and it was considered a cheap and abundant resource. However, with population growth and much larger communities requiring access to water services, the availability of freshwater is decreasing dramatically in many regions of the world.

Water tariffs are economic instruments that can help tackling both challenges of providing water and sanitation services to all citizens at an affordable price and the conservation of water resources. Proper water tariffs provide incentives to improve sustainable water and sanitation services and to use water resources more efficiently:

- Tariffs can generate revenues to recover specific costs (e.g. operation and maintenance costs)
- Tariffs can generate funds for necessary infrastructure development and expansion as well as for wastewater treatment, hence assuring water quality protection.
- Charges can send appropriate price signals to users about the relationship between water use and water scarcity
- Having to pay for water can encourage people to reduce wasting water
- Subsidising tariffs for low-income groups ensure that poor households also have sufficient and affordable water services.

If water service is not financed by other sectors tax incomes, adequate water tariffs are required to assure well functioning water and sanitation systems. Low levels of cost recovery from users and other sources, lead to insufficient income for the effective and efficient operation and management of the service. This implies a poor ability to invest in the sector, whether through human investment or capital investment. As a result, poor service ensues, leading to the dissatisfaction of users thus





decreasing to pay, which, on top of already poor cost recovery levels, further exacerbates the system. (Cardone and Fonseca 2004).

### **Water Tariffs - a Controversial Topic**

(Main source Cardone & Fonseca 2004)

Pricing water is a very controversial topic and there is plenty of disagreement about the “right” way of doing it.

Water tariffs are a powerful management tool to achieve various objectives in the water and sanitation sector. However setting tariffs is a political process that quite controversial. Low tariffs are set often for political purposes, rather than for economic sustainability. Free water can be seen as a campaign promise, for political gain, but on the other side as basic service provided to poor people for social purposes.

Tariff structures are often complex and difficult to understand for consumers. People are not generally aware about the costs of providing water and sanitation services, it is difficult for them to judge what a “fair” or appropriate price to pay is. Moreover, it must be considered that poor without access to public water network are already paying a high proportion of their incomes either in excessive charges for poor quality water from water vendors, or in lost productivity through time taken, mostly by women, to collect water from distant sources. Many poor would be willing and able to pay for appropriate low-cost services, if they were shown to be convenient and reliable. Water to everyone must also be in any case guaranteed as a basic right of humankind.

There is disagreement over the objectives of water pricing and tariff design. Tariff setting practises affects the goals of different stakeholders in conflicting ways: consumers need affordable and equal water services whereas utilities require stable revenues for cost recovery and economic efficiency. A tariff structure alone cannot cover all the needs.

Often, there is a lack of empirical data about how the application of different tariff structures affects water use for different consumer classes and whether or not price changes would affect customers’ decisions to connect (or stay connected) to the water distribution system.

There are no market tests for different water tariff structures. Consumers are usually not involved in the design and setting of tariff structures and they cannot reject inappropriate tariff structures because these are typically set by the regulatory agency (WHITTINGTON 2006).

## **2.2. Regulatory Environment and Main Stakeholders**

(Main source LE BLANC 2008)

Water and wastewater tariffs need to be set, and from time to time, revisited and adapted. The process is often complex and can involve some or all the stakeholders mentioned below. Outside consulting firms, lending institutions and political leaders may be involved as well. The tariff may be determined by a formula embodied in national legislation (e.g. Ukraine), which may also be administered and regulated by a national regulatory body (e.g. Colombia).



## Thematic Catalogue 3

At the national level, the following entities usually have a say in defining the environment in which water and sanitation management take place:

- The state (ministries in charge of water and sanitation, ministries in charge of social programmes for the subsidy aspect),
- The regulating agency,
- Municipalities, which are typically responsible for basic service provision in their jurisdictions, and may own local utility companies.
- Water utility companies (public or private);
- Alternative providers (communities, private sector entities);
- Consumers (households, agricultural, commercial and industrial), directly or through intermediaries, e.g. community representatives.

### 2.3. Water and Wastewater Tariff Design

(Main Sources: Whittington 2003, 2006; Cardone & Fonseca 2003, 2004)

Water and wastewater tariffs are usually designed as a single part tariff or as a combination of two tariff structures. Charges can be set depending or not from the volume of water consumed. In the first case water metering is needed. A brief overview of water and wastewater tariffs generally adopted by water utilities is given below:

- Fixed charge: the monthly water bill is independent of the volume consumed.
- Uniform volumetric tariff: is a volumetric charge with a rate proportional to water consumption (metering is needed). All units (cubic meters) are priced the same rate, independently of total consumption.
- Increasing block tariff: is a step-wise volumetric charge (metering is needed). With this tariff the unit charge is constant over a specific range of water use block) and then increases as the consume increases.
- Decreasing block tariff: is the opposite of the increasing block tariff: the rate per unit of water is high for the initial (lower) block of consumption and decreases as the volume of consumption increases.
- Two parts tariffs: have a fixed charge component plus a variable charge depending on the volume of water consumed (e.g. increasing block or uniform tariff). Two parts tariffs are widely promoted by the World Bank, aim at recovering costs and achieving economic efficiency. The fixed part usually corresponds to the fixed costs of production and administration and the proportional part can be adjusted to the marginal cost.

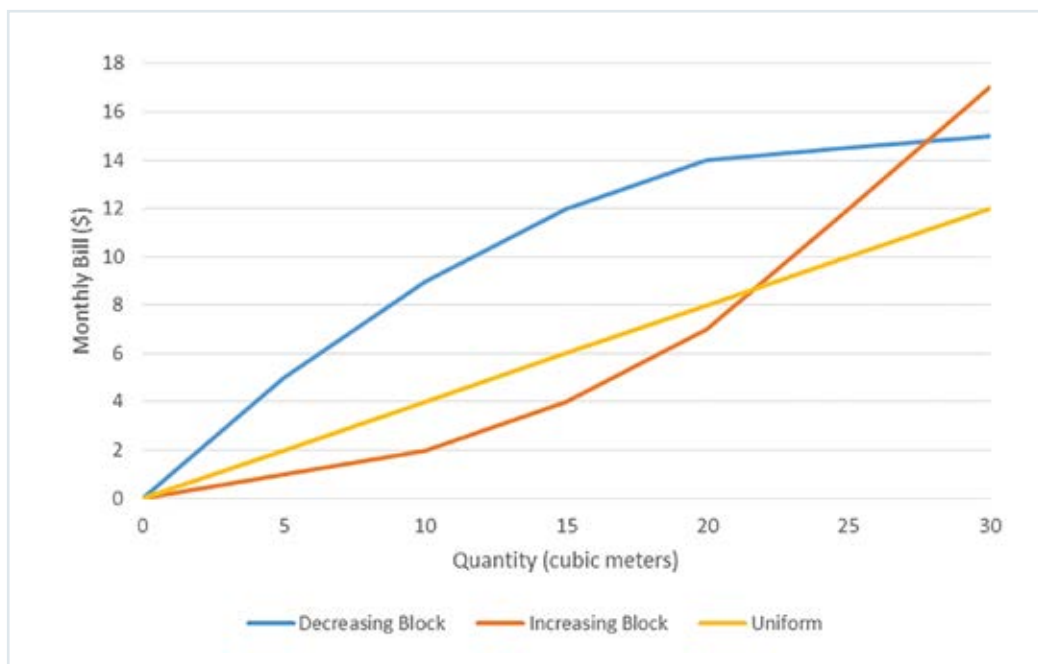

Monthly water bill versus the quantity of water used for selected tariff structures. The figure illustrates how the customer's monthly water bill varies as the quantity of water used increases for selected tariff structures. Source: Adapted from Whittington 2006.

Water tariffs are applicable at different levels: they can be set either at the service provider level or by national (or local) governments. Tariffs can be categorised in consumer categories and classes and they can be designed within a policy framework that addresses different needs.

Policy makers need to decide which objectives have the highest priority, and where possible, use a range of instruments to help their decisions.

Involvement of local communities in the tariff setting process is important to identify the real local needs, the costs of providing a good quality service, and the best ways to recover the costs incurred.

### 2.3.1. Fixed Charge

With a fixed water charge, the consumer pays a monthly water bill, which is the same independently of the volume consumed. In absence of a water metering system, a fixed water charge is the only possible tariff structure.

Fixed water charges are commonly found in countries where water has historically been abundant and hence metering was not needed to give people an incentive to reduce water consumption. Fixed charges are still quite widely used in industrialised countries, such as Canada, Norway, and the United Kingdom (and until recently in New York City). Despite a lot of water shortages, we find fixed charges also in many small and medium size cities in India, where they are still the most prevalent way to calculate the monthly water bill.

The fixed charge itself can vary across households or consumer classes depending on characteristics of the consumer. Parameters for setting a fixed charge are for example a higher income and/or greater ability to pay. Higher fixed charges were historically set on valuable residential properties on the assumption that people with a higher income tend to use more water and/or have a greater ability to pay for the water they use. For the same reason it is common to assign commercial entities



a different fixed charge than for households. Another common parameter for setting a fixed charge is the diameter of the pipe used by the customer to connect to the distribution system. Households, which generally require a smaller bore than connexions for larger concerns (e.g., businesses, hospitals), are commonly set a lower fixed charge.

A fixed water charge offers some benefits deriving from its simplicity and the fact that it is applicable without a metering system, which is expensive to implement. On the other hand, consumers have no incentive to economise on water use with a fixed tariff, as using more water will not increase their water bill. Furthermore, some of the water might be sold at high prices by street vendors to the households with no access to the taps or connexions. From the cost recovery point of view, “a fixed charge that provide sufficient revenues at one point in time will become increasingly inadequate as the economy and incomes grow and water use increases. Water utilities will be than reluctant to expand coverage because more customers may mean more financial losses. Fixed-charge tariffs are thus especially prone to locking communities into low-level equilibrium traps of few customers, low revenues, and poor service”.

### 2.3.2. Uniform Volumetric Tariff

In a uniform volumetric charge, or constant volumetric tariff, all water units are priced the same independent of the use, and consumers pay proportionally to their water consumption. With this type of tariff, all consumers (domestic, industrial and commercial) pay the same unit rate, and their water bill corresponds directly to the quantity of water consumed. Prerequisite for setting a uniform volumetric charge is that consumers have a metered connexion to the water system. The constant volumetric tariff can be designed as a single tariff or as a two part tariff combined with a fixed charge. This type of tariff is the most common water charge in OECD countries, and it is very common throughout the world. Volumetric price schemes present several advantages: first of all is easy to understand for consumers - because it is how most other commodities are priced - furthermore it sends a clear signal to the consumers about the cost of supplying them with additional water. Moreover, the tariff incorporates the concept of water conservation as the water bill increases with consumption.

The uniform volumetric charge is applicable everywhere water is provided and/or wastewater is collected, and where a metering system is in place. The uniform tariff can be set at the service provider level or by national or local government. Involvement of local communities in the tariff setting process is important to identify the real local needs, the costs of providing a good quality service, and the best ways to recover the costs incurred.

### 2.3.3. Increasing Block Tariffs

Water and wastewater tariffs determine the level of revenues that service providers receive from users in centralised or semi-centralised systems for the appropriate catchment, purification and distribution of freshwater, and the subsequent collection, treatment and discharge of wastewater. Water pricing is an important economic instrument for improving water use efficiency, enhancing social equity and securing financial sustainability of water utilities and operators. Tariff setting practices vary widely around the world. Here, we will introduce the increasing block tariff as type of step-wise volumetric charge commonly used in many countries.

#### Advantages



## Thematic Catalogue 3

- Ensures cost recovery by well designed size and height of the blocks
- Poor households connected to the network are provided with affordable water
- Promotes water conservation

### Disadvantages

- Tariff design is complex
- Difficult to implement, especially if there is no metering system in place
- Penalises poor families with large households and/or shared connections

With increasing block tariffs, the rate per unit of water increases as the volume of consumption increases. Consumers face a low rate up to the first block of consumption and pay a higher price up to the limit of the second block, and so on until the highest block of consumption. At the highest block consumers can use as much water they desire, but for each additional water unit consumed they pay the highest price in the rate structures. Increasing block tariffs are by far the most common charges for water services. They are used in countries where water has been historically scarce such as in Spain and the Middle East and they are widespread in developing countries.

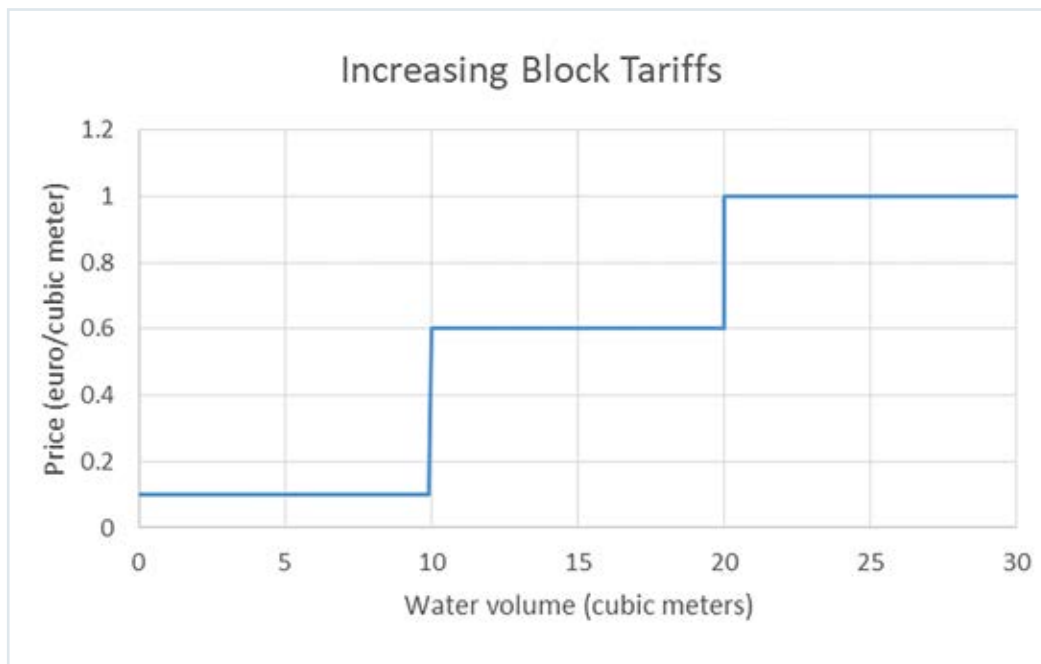

*The graph shows an example of how the price of water to the consumer changes as the quantity of water used increases for increasing block tariff. Source: Adapted from WHITTINGTON (2006)*

In order to design an increasing block structure, the regulator must decide for each category of water use:

- The number of blocks.
- The volume of water use associated with each block.
- The prices to be charged for water use within these blocks.

Water blocks design is generally based on consumption pattern of the public and on per capita water consumption.



## Thematic Catalogue 3

An ideal progressive tariff structure would contain three blocks:

- A “social” block with a volume of water corresponding to the essential minimum consumption, (e.g. 4 to 5 m<sup>3</sup> per month and household (5 persons), corresponding to the minimal needs)
- A “normal” block corresponding to the average consumption defined on the basis of the marginal cost (e.g. from 5 to 12 or 15 m<sup>3</sup> per month for a standard family of 5)
- A “high” block above 12 or 15 m<sup>3</sup> per month set at a price designed to finance the full cost of the service

The first block, also called lifeline block is normally set below cost. The aim is to provide the poor with inexpensive water, while charging the highest prices to richer customers and companies – who are known to use more water and have a greater ability to pay. By charging higher prices for high consumption, increasing block tariffs are also meant to discourage excessive water use. Increasing block tariffs can be also designed as a two-part tariff. In that case, in addition to a variable tariff based on consumption, a monthly fixed rate is charged for all consumers.

In reality, block tariffs are often more complex and the design process is not always transparent.

The design of the lifeline block is a delicate issue as it is rife with social implications. Regulators may be reluctant in limiting the size of the initial block because of political pressures.

In some cases increasing block, tariffs may have unintended effects on the poor. In theory, low-income households with private metered connexion benefit from the subsidised rate, but this is not always the case if poor households are sharing a single connexion – as it is for example very common in India – that drives consumption and rates higher, with the result that poor households finally pay more than better-off users.

Increasing block tariffs are applicable everywhere where water is provided and/or wastewater is collected. However, a metering system is required. Block tariffs can be set at the service-provider level or by national or local government. Involvement of local communities in the tariff setting process is important to identify the real local needs, the costs of providing a good quality service, and the best ways to recover the costs incurred.

### 2.3.4. Decreasing Block Tariffs

With decreasing block tariffs, the rate per unit of water is high for the initial (lower) block of consumption and decreases as the volume of consumption increases.

This type of tariff structure was designed because “when raw water supplies are abundant, large industrial customers often impose lower average costs because they enable the utility to capture economies of scale in water source development, transmission, and treatment. Also, industrial users typically take their supplies from the larger trunk mains, and thus do not require the expansion of neighbourhood distribution networks”.

Well-designed decreasing block tariffs allow utilities to recover costs. However, they penalise consumers with low level of consumption and provide a disincentive for reducing wastage of water. There is a trend to move out of these kind of tariffs, essentially because water conservation has found place in the political agenda of many governments and marginal costs of providing water are now relatively high in many countries, hence decreasing block tariff are not any more profitable for utilities. Decreasing block price scheme are still used in some communities of the USA and Canada, though in recent years other volumetric tariffs (e.g. uniform price and increasing block) are more frequently applied.



## Thematic Catalogue 3

In order to design an decreasing block structure, the regulator must decide for each category of water use:

- The number of blocks.
- The volume of water use associated with each block.
- The prices to be charged for water use within these blocks.

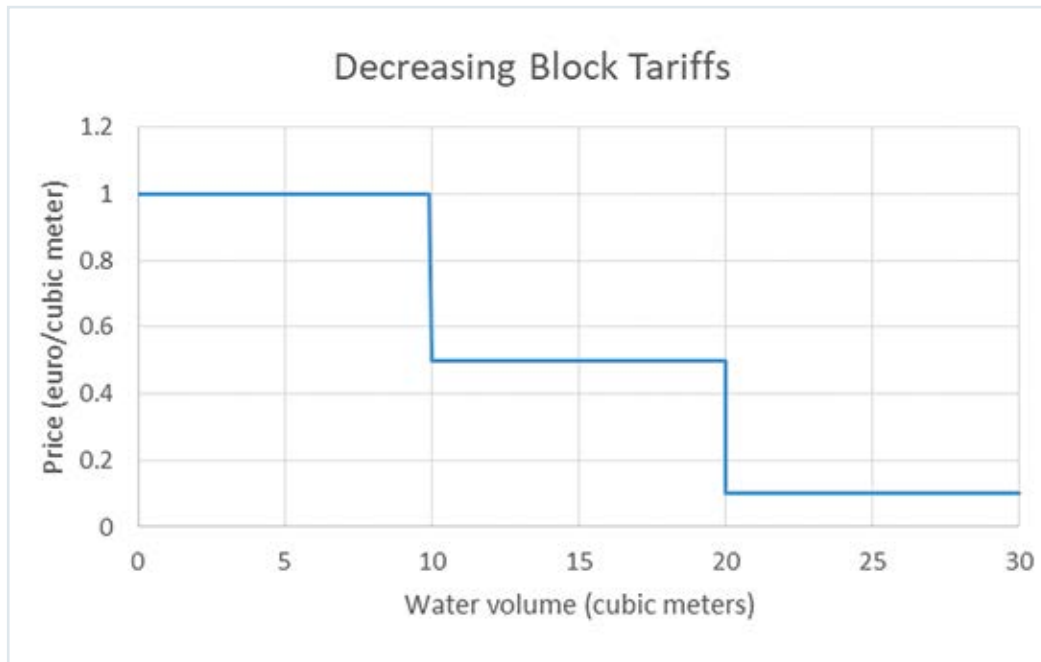

The graph shows an example of how the price of water to the consumer changes as the quantity of water used increases for increasing block tariff. Source: Adapted from Whittington (2006)

The decreasing block tariff can be applied everywhere where water is provided and/or wastewater is collected. A metering system is required. Block tariffs can be set at the service provider level or by national or local government. However, this type of tariff is not regarded to be sustainable from a social or ecological point of view, as those who consume least (usually the poor) have to pay the highest price per unit. Furthermore, this tariff encourages consuming more instead of less water, which can put limited water resources under pressure.

## 2.4. Example: Design of a new tariff in Bologna BLUEAP



(Main source <http://www.blueap.eu/>)

One of the actions of the BLUEAP Adaptation Plan of Bologna (Italy) aims at further reducing the daily use of water per capita for domestic uses to 130 l/day by 2025. The previous goal was 150 l/day by 2016.

To reach the goal it is necessary to redesign the water tariff in order to discourage a daily consumption above 130 l, by increasing the price of water above that threshold. The tariff design must not increase the expenses for those citizens that already consume less than 130l per day.



## Thematic Catalogue 3

The designing of the new tariff will follow preliminary studies and simulations about the effects of behavioural change due to the new tariff. The design will be carried out involving several stakeholder such as the regional agency for water services, the local water distribution company as well as social and environmental associations.

To prevent any negative social impact of this decision, a campaign for awareness raising will come with the design of new tariffs. Citizens must be engaged and informed about the importance of water saving by installing water saving devices and by behavioural change. In particular citizens need to acknowledge that the new tariff rewards sustainable behaviours and that reducing water consumption can also lead to economic savings.

### Overview table: Water Pricing System in Smart Governance

#### General Objective

- Increase efficiency in water use and distribution
- Promote multiple water use and water sustainability

#### Specific Goals

- Reduce consumption of fresh water (by increasing the water selling rate)
- Foster and encourage the use of recycled water (by decreasing the price of reclaimed water)
- Promote water conservation
- Allow an adequate water availability at fair price to guarantee a standard use for everybody
- Pursue social acceptability, don't reduce life quality

#### Standard approach difficulties

- No water meter for each apartment
- Unpopular policy for some users
- Tariff setting is a political process with controversy
- Tariff design is a complex process that needs high volume of data so difficult to fix prices
- Reduction of water consumption is against the economic interests of water utilities:
  - water and wastewater utilities have a high part of fixed costs
  - water saving causes the sales volume to drop reduction in income, costs remain unchanged

#### Smart Governance approaches

- Revenues should pay for investment, operations and maintenance
- Water must be affordable for everybody
- Tariffs design as a shared decisions
- Smart tariffs should guarantee a standard need for water for each person at a low price, discourage water over-consumption
- Tariffs that incentive Greywater reuse and rainwater harvesting
- Tools supporting awareness of water use
- Tests new tariffs before introductions and monitoring of effects





### Overview table: Water Pricing System in Smart Governance

#### **Citizen engagement and communication strategies**

The choice of the water tariffs should involve stakeholders and, in particular, citizens in the decision process. A survey among citizens could be set in order to design tariffs according to its outcomes.

A sample of citizens could be engaged to test a smart use of water, to evaluate the benefits of water saving linked to alternative water tariffs.

The test should prove a potential social acceptance of changes in water tariffs, and increase citizens awareness on water saving.

The change of water tariffs is a very delicate topic that can rise disapproval by part of the citizens. This action must be very carefully communicated before its implementation to prevent disapproval by making understand to the citizens its goals and its advantages for single users and the community.

The key messages to be delivered are:

- The action aims at reduce waste of clean water
- Saving water doesn't affect the quality of life
- Saving water resources has an important impact on environment
- Eventually depending on the tariff scheme chosen, water price is not increasing or even lowering for virtuous citizens

All these key messages must be communicated with the support of real and transparent data.

To test the solutions - before its implementation - could be meaningful set pilot cases. The success of this case is the best way of communicating the goodness of the solutions proposed. Moreover, citizens can find more trust and transparency in the actual effects of the solution, when tested by other citizens, more than a standard top-down information.

---

#### **Sources and further examples**

Ricato Martina, Water Pricing, sswm.info, 2019

Cardone, R. Fonseca, C. (2003): Financing and Cost Recovery. Delft (The Netherlands): IRC (International Water and Sanitation Centre). Thematic Overview Paper 7

Whittington, D. (2002): Tariffs and Subsidies in South Asia: Understanding the Basics. Washington, D.C.: Water and Sanitation Program; World Bank Institute

Blanc, D. le (2008): A Framework for Analyzing Tariffs and Subsidies in Water Provision to Urban Households. New York: DESA Working Paper n°6

Rogers, P.; Silva, R. de ; Bathia, R. (2001): Water is an Economic Good: How to use Prices to Promote Equity, Efficiency, and Sustainability. In: Water Policy : Volume 4 , 1-17.

Water Tariffs in Cyprus, Theodoros Zachariadis (Cyprus University of Technology)

<https://www.wbl.com.cy/en/page/water-rates>

<https://lwb.org.cy/en/charges-and-fees.html>

<http://www.blueap.eu/>



## 3. Water conservation programs

Water conservation programs aim at reducing the exploitation of water resources. They can vary significantly by the specific goals they need to pursue.

Water conservation programs can concern the whole society, including private citizens, industry, agriculture, and all the sectors that are water consumers, or they can focus on one particular category of water consumers.

The actions in a water conservation programs can also be much different depending on the target: education, financial support to the installation of household water saving facilities, or to bigger water systems, behavioural change incentives.

Water conservation program can be then composed by many smart water governance features, as described in this Catalogue, and can regard the support of the implementation of innovative engineering and Nature-Based-Solutions described in Catalogue 2.

Water savings in households is carried out by introducing water saving devices and by educating users to a more sustainable and wise water consumption.

Many options are available to contribute to water saving: all the water sources in a house could be enhanced to reduce water consumption.

All the faucet in the bathroom, and eventually in the kitchen, such as sinks, bidets, showers and bath can be equipped with flow regulators and/or aerators that reduce the water flow.

Toilet flush can be adapted to reduce the amount of fresh water lost in every single use.

Washing machine should be purchased with care on its water consumption.

Moreover toilet flush could use non-fresh water such as treated grey water or rain water. As well as washing machine and possibly showers and baths could use rainwater.

Citizens can be engaged to improve their water use especially by reducing waste of fresh water, such as closing the faucet when not needed, e.g. while brushing teeth or taking shorter shower and/or close the faucet while lather up.

Water flower and plant with waste water from the kitchen, e.g. after washing vegetables and fruits. A water conservation program need to coordinate both equipment and habits and can be fostered by communication campaigns that promote both the purchase of equipment and the behavioural change.

Some examples in this chapter show possible application to be included in a water conservation program.

### 3.1. Chicago's voluntary Meter-Save program

Chicago's Meter-Save program, which installs residential water meters free of charge, is designed to promote water conservation. Any resident current on their water bills who owns a single family home or two-flat qualifies for the program. More than 117000 new meters have been installed since the program began in 2009.



## Thematic Catalogue 3

This program is successful because people are seeing considerable savings with completely free installation and a seven-year guarantee that bills will be no higher than they would be without a meter, there is no downside to participating.

Non-metered customers pay a flat fee for water every six months. Metered customers pay only for the water they actually use. This amount tends to be well below the estimate calculated by the non-metered payment formula. The program also offers indoor or outdoor water conservation kits as incentives for signing up.

### 3.2. Co-design with citizens - Start Park, Prato - Italy

(Source: <https://www.startpark.org/>)

A successful case of co-design with citizens in the field of NBS to improve the city water cycle is the Start Park in Prato, Italy. The Start Park was born as a concept during the Climathon 2017 promoted by Climate-KIC and organized thanks to the collaboration between GreenApes, Codesign Toscana and Impact Hub Firenze. In that occasion multidisciplinary teams challenged to come up, in 24 hours, with innovative solutions as responses for the mitigation of Climate Change effects and extreme weather events.

In particular the design challenge, under the category “Resilience & Water” was “How might citizens and local actors contribute in raising city’s resilience to tackle the more and more frequent extreme climate events (from droughts’ period to intense meteoric events)?” From this challenge came up a systemic service that merged public/private interest and facilitate the growing of resilient urban parks and shared awareness about climate crisis.





The team behind Start Park has been working since fall 2018 by using collaborative design techniques and lean management tools to organize and orchestrate the development of Start Park project. They organized a workshop open to professionals (architects, designer, engineers, social activists and social innovators) to redefine the concept (January 2019). Subsequently, Start Park has been awarded with the winning of two Designsapes (Horizon 2020) | Design-enabled innovation in urban environments grants. Thanks to them, they have prototyped a Start Park in the city of Prato involving both the local community and the Municipality and are currently scaling it in Lucca, again with the cooperation of the Municipality of the city and a group of local citizens.

### 3.3. A participatory modelling approach for sustainable urban water management, Ebbsfleet Garden City, UK

(Source: A participatory system dynamics model to investigate sustainable urban water management in Ebbsfleet Garden City, Irene Pluchinotta et al., Sustainable Cities and Society • January 2021)

Urban water management (UWM) challenges in the Ebbsfleet Garden City (UK) were investigated via a participatory process and potential sustainable solutions were explored using a System Dynamics Model (SDM). Collaborative development of the SDM by the Ebbsfleet Learning and Action Alliance developed stakeholders' understanding of future UWM options and enabled a structured exploration of interdependencies within the current UWM system. Discussion by stakeholders resulted in a focus on potable water use and the development of the SDM to investigate how residential potable water consumption in the Ebbsfleet Garden City might be reduced through a range of interventions, e.g., socio-environmental and economic policy incentives.

The SDM approach supports decision-making at a strategic, system-wide level, and facilitates exploration of the long-term consequences of alternative strategies, particularly those that are difficult to include in quantitative models. While an SDM can be developed by experts alone, building it collaboratively allows the process to benefit from local knowledge, resulting in a collective learning process and increased potential for adoption.

The primary modelling research question, and an early outcome of the study, became: ‘How might residential potable water consumption in the Ebbsfleet Garden City be reduced through a range of interventions, such as socio-environmental and economic policy incentives or physical interventions?’

The co-development of the SDM took place over five stakeholder workshops:

- Workshop 1 - Problem definition
- Workshop 2 - Exploring the problem dimensions
- Workshop 3 - Towards a preliminary CLD Causal Loop Diagram
- Workshop 4 - Validating the CLD
- Workshop 5 - Validating the SDM and scenario building
- Workshop 6 - Scenario analysis presentation

The Causal Loop Diagram resulted from the workshop is presented in figure.



## Thematic Catalogue 3

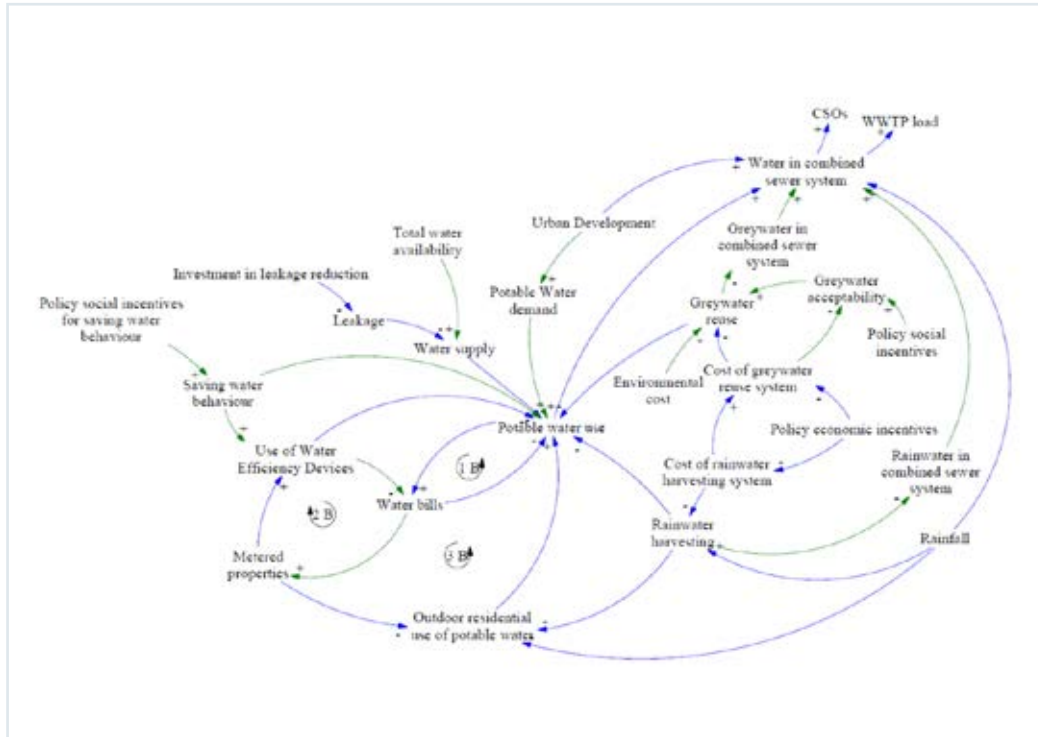

Figure: Final Causal Loop Diagram (CLD) for the Ebbsfleet Potable Water Use problem dimension

The model focuses on a systematic analysis of the urban water supply system in the Ebbsfleet Garden City. The model is built upon the principle of water balance, performing a comparison between water demand and water supply and considering the potential impact of strategies such as Rainwater Harvesting (RWH) and Greywater Reuse (GWR). It runs over a time scale of 30 years, accounting for the evolution of the city from 2019 to 2049. The simulation is based on a yearly time step (i.e. the water balance is computed annually) and it is focused on future residential development (i.e. it does not consider the existing buildings). Individual stakeholders' behaviours are aggregated for this analysis. Variables such as 'Command and control regulatory policy instruments', 'Social Environmental Incentivising Policy Instruments' and 'Economic Incentivising Policy Instruments' represent the possible macro areas of intervention for strategies and measures suggested by the stakeholders during the last participative workshop.

Different strategies were proposed and co-designed through a participatory exercise during the fifth stakeholder workshop and separated into different policy instruments. The scenario analysis aimed to semi-quantitatively assess the impact of the different strategies on the model output variables in order to identify suitable combinations of strategies, understand their effectiveness, potential consequences, side effects and synergistic impacts, and discuss the feasibility and the relevance of the selected strategies, in view of the main objective (improving the sustainability of water management in the Ebbsfleet Garden City).

By investigating several potential future scenarios, the stakeholders were able to explore how different strategies might play out in the longer term, and how different strategies might be combined to achieve optimum urban water consumption.



## Overview table: Water conservation programs in Smart Governance

### General Objective

- Increase efficiency in water use and distribution
- Guarantee good quality of water bodies
- Promote multiple water use and water sustainability
- Preserve flow in water bodies

### Specific Goals

- Save water resources and increase the water amount for people in water scarcity areas
- Reduce water abstraction
- Ensure habitats and living conditions of plants and animals who are dependant of wet areas
- Save energy for abstraction and allocation of water
- Reduce materials for the supply network and for the sewer network (smaller diameters of pipes or even eventually no need to install sewer pipes)
- Minimising the costs and the efforts for treating the outgoing wastewater (less volume)
- Reduce the monthly bill from the water works

### Standard approach difficulties

Water saving requires both a proper availability of infrastructures/facilities and a citizens awareness and behavioural change.

If citizens are not properly involved in water saving intervention the benefits can be below expectation or not lasting.

Without metering the tap water and supervising the water consumption it is quite difficult to obtain a water saving effect.

The best water saving measure is the individual metering of water consumption of a household.

### Smart Governance approaches

The standard approach could be enhanced by introducing more stakeholder engagement, by adopting innovative technologies and by including water conservation programs within a wider environmental and social sustainability strategy.

To increase the smartness of a water conservation program dedicated to households the focus is on smart meters that provide a better data availability and a raise of awareness in consumers.

Smart water meters allow measuring the precise water consumption, not only a monthly or yearly water consumption but a detailed day by day or hour per hour measure. Moreover, the count of water consumption is split for each single apartment, and it's not roughly counted at a condominium level.



### Overview table: Water conservation programs in Smart Governance

#### **Citizen engagement and communication strategies**

Citizens must be considered not only as final user of a water conservation program, but they should be involved in designing policy and intervention.

Involving citizen in the actual implementation of interventions rise their awareness and care.

Advanced modelling tools design can also benefit from citizen contribution, if proper co-development activities are designed.

---

#### **Sources and further examples**

[www.metersave.org/MeterSave](http://www.metersave.org/MeterSave)

[www.startpark.org](http://www.startpark.org)

[www.sciencedirect.com/science/article/abs/pii/S2210670721000044](http://www.sciencedirect.com/science/article/abs/pii/S2210670721000044)

[www.valleywater.org/water-conservation-programs](http://www.valleywater.org/water-conservation-programs)

[ncsd.ca.gov/resources/save-water-save-money](http://ncsd.ca.gov/resources/save-water-save-money)

[www.toolkit.bc.ca/elements-water-conservation-programs](http://www.toolkit.bc.ca/elements-water-conservation-programs)

[www.snwa.com/business/water-conservation-programs/index.html](http://www.snwa.com/business/water-conservation-programs/index.html)

---



## 4. Monitoring the water cycle

Monitoring can be applied in several contexts related to water: users behaviour in water use can be monitored, as well as the results of facilities installation. The monitoring can regard the use of fresh water, the waste water and also the harvesting of rain water or the reuse of grey water.

The monitoring process can aim at increasing knowledge about the urban water cycle, but can also aim at testing the ability of an implemented set of interventions to achieve their goals, and on the other side at promptly recognising potential unwanted effects and adopt corrective measures, eventually including mitigation and compensation measures.

The monitoring process has three stages: analysis, diagnosis, therapy. In the analysis stage, information is collected to analyse the impacts of the implemented interventions. During the diagnosis stage, if the impacts are not as forecasted and there are unwanted effects, the reasons of the deviation are understood. Finally, in the therapy stage a decision is taken to understand if and how to intervene to make things work better.

The design and implementation of the monitoring process requires to identify:

- the governance system, i.e. the involved subjects/stakeholders and their competences and roles.
- contents and periodicity of the monitoring reports and their periodicity
- role of participation of the different subjects
- procedures and rules to re-orient the interventions if needed

The monitoring effectiveness strongly relies on the interactions among the different subjects, which themselves need some conditions, like the existence of a shared knowledge base and of accessible information, the transparency of procedures, timeliness of information, and a good scheduling of the processes.

For a proper usability at different scale, the monitoring indicators and governance must be designed for a maximum integration of different administrative levels and sectors.

In water management data are fundamental for a proper monitoring and to build model for a better planning. A better availability of data about the water cycle can help in taking correct decisions and especially to address a smarter use of water that allows a better water saving.

An example of trans disciplinary approaches connecting science and technology with society is the establishment of the Platform on Water Resilience and Disasters, a worldwide project promoted by the International Flood Initiative. Further efforts at enhancing accessibility of water-related societal information is the UN-Water SDG 6 data portal and the Aqueduct Water Risk Atlas, a global water risk mapping tool that helps companies, investors, governments and other users understand where and how water risks and opportunities are emerging worldwide.

Data integration and analysis are important and need to be strengthened in order to help reduce the risks and impacts of water-related disasters, including floods, landslides and droughts, the prediction of which rely greatly on science and technology for early warnings. Further, hydrological data need to be integrated with social and economic analyses, since behaviour and resilience depend greatly on who has access and control over different resources (2030 WRG/UNDP, 2019).





## 4.1. Smart approach to monitor rainwater harvesting

The development of Internet of Things tools in Smart Cities can be applied to Rain water harvesting. Examples of these technique are show in the papers “Smart Approach of Harvesting Rainwater and Monitoring Using IoT”, V S P Chandrika Kota et al., 2020 and “Smart city rain water harvesting (IOT) techniques by J.Vinoj and Dr.S. Gavaskar, 2018.

The smart approach consists in installing electronic devices that measure the amount of water harvested and communicate to a central system that can monitor the process of rainwater harvesting. Each device can be geotagged to process the information about its location such as weather forecasts.

The government of Andhra Pradesh of INDIA has consolidated statistics about the amount of rainfall over the last decade, drawing statistics of rainfall and ground water level in the various districts of the state.

Geotagging allows to add a geographical location, its data usually consists of coordinates, though they can also include altitude, bearing, distance, accuracy data, and place names, and perhaps a time stamp. Geotagging can help users to find a wide variety of location specific information from a device. For instance someone can find images taken near a given location by entering latitude and longitude coordinates into a suitable image search engine. Geotagging enabled information services can also potentially be used to find location based news, websites, or other resources. Geotagging can tell users the location of the content of a given picture or other media or the point of view, and conversely on some media platforms show media relevant at a given location.

The smart approach requires bot devices and software to function. In the mentioned examples the devices to monitor harvested rain water were based on Arduino and were connected with KoBoCollect application.

Arduino is an open-source electronics platform based on easy-to-use hardware and software. Arduino boards are able to read inputs - light on a sensor, a finger on a button, or a Twitter message - and turn it into an output - activating a motor, turning on an LED, publishing something online. The user can tell to the board what to do by sending a set of instructions to the microcontroller on the board by using the Arduino programming language (based on Wiring), and the Arduino Software (IDE), based on Processing.

KoBoToolbox is a suite of tools for field data collection for use in challenging environments. It is a free and open source software. Smart rainwater harvesting pit requires a KoBoCollect app to be installed and properly set. Once the main settings such as longitude, latitude, altitude and accuracy are set, the app starts collecting data.

By integrating connecting pits the amount of water harvested and ground water recharged can be monitored with its location.



## 4.2. Water quality of rainwater harvesting systems

(Adapted from Luke Mosley, Water quality of rainwater harvesting systems, 2005 SOPAC Miscellaneous Report 579)

Good drinking water quality is essential to the health and well-being of all people. Acceptable water quality occurs when:

- there are no bacteria of faecal origin present that may cause human diarrhoea and other life-threatening diseases (e.g. typhoid fever),
- there is no levels of chemicals (e.g. heavy metals) or chemical substances that would cause harm to human health,
- water does not have a bad taste or smell.

To protect human health, water sources must be protected from contamination and the piping system to the consumer must be maintained in good condition (no breaks or leaks). In most municipal water supply systems, water is taken from sources such as boreholes, rivers and lakes. These sources are relatively easily contaminated if human waste from sanitation systems (e.g. septic tanks, pit latrines), or animal waste, is discharged onto the land nearby to the water source. This necessitates water treatment such as filtration and chlorination in order to provide safe drinking water.

Rainwater collection systems are commonly believed to provide safe drinking water without treatment because the collection surfaces (roofs) are isolated from many of the usual sources of contamination (e.g. sanitation systems). In almost all Pacific Island countries properly collected and stored rainwater is likely to be superior to untreated surface and bore water supplies but this may not always be the case. Although roofs are higher than the ground, dust and other debris can be blown onto them, leaves can fall from trees, and birds and climbing animals can defecate upon them. The quality of drinking water can be much improved if this debris is not allowed to enter the storage tank.

The types of contaminants commonly found in rainwater collection systems are listed below:

Contaminant	Source	Risk of entering Rain Tank
Dust and Ash	Surrounding dirt and vegetation Volcanic activity	Moderate: Can be minimized by regular roof and gutter maintenance and use of a first-flush device.
Pathogenic Bacteria	Bird and other animal droppings on roof, attached to dust	Moderate: Bacteria may be attached to dust or in animal droppings falling on the roof. Can be minimized by use of a first-flush device and good roof and tank maintenance.
Heavy metals	Dust, particularly in urban and industrialised areas, roof materials	Low: Unless downwind of industrial activity such as a metal smelter and/or rainfall is very acidic (this may occur in volcanic islands).
Other Inorganic Contaminants (e.g. salt from seaspray)	Seaspray, certain industrial discharges to air, use of unsuitable tank and/or roof materials	Low: Unless very close to the ocean or downwind of large-scale industrial activity.
Mosquito Larvae	Mosquitos laying eggs in guttering and/or tank	Moderate: If tank inlet is screened and there are no gaps, risks can be minimized.



## Thematic Catalogue 3

Water quality testing should ideally be regularly carried out by a relevant in-country agency, such as the Ministry of Health. WHO (World Health Organization, Guidelines for drinking-water quality, 4th edition, 2017) provides guidelines to determine whether water quality standards are met. Unfortunately, testing of the quality of rain tank water is not often performed as these systems are not part of the municipal water supply and hence are often considered the responsibility of the individual householder. However in some locations the Ministry of Health conducts testing and public education on rainwater tanks. Where testing is not performed, communities should lobby relevant government agencies to begin conducting regular testing. This can provide guidance as to when tanks need to be cleaned or disinfected. Simple water quality testing equipment (e.g. hydrogen sulphide, H<sub>2</sub>S, tests) could be supplied to communities so they can self-test their water. These tests have been shown to correlate well with faecal coliform levels in rainwater tanks (Faisst and Fujioka 1994).

If water quality testing is possible, the main focus should be on microbiological testing using tests such as faecal coliforms, Enterococci, and the simple H<sub>2</sub>S test. World Health Organization guidelines (WHO 1996) state that faecal bacteria should not be detectable per 100 mL of sample. However, Fujioka (1994) stated that a more realistic standard may be 10 faecal coliforms/100 mL. Rainwater tank is unlikely to have contamination from human faecal wastes. Total coliform tests are not considered a reliable indicator of risk to human health in the tropics as they are naturally present and can reproduce in the soil and water (Fujioka 1994; WHO 1996).

The physical parameters, pH and turbidity should also be measured and compared to WHO guidelines. Rain is considered acidic when the pH is <5.6, and levels below this may cause corrosion of metal roofs and fittings. Heavy metals (e.g. lead, copper, cadmium, zinc) should also be monitored periodically, particularly where volcanic or industrial discharges to the air are present.

Given the current lack of testing for rain tank water, it is imperative that households are given good education (workshops, printed material) on maintaining their tanks. This should be an integral part of any rainwater tank installation project.

### 4.3. Turning Smart Water Meter Data Into Useful Information

(Source: Turning Smart Water Meter Data Into Useful Information A case study on rental apartments in Södertälje , Philip Dahlström, Anna Söderberg, 2017)

The article by Philip Dahlström and Anna Söderberg highlights that water in urban areas is an ever increasingly complex challenge and technology enables sustainable urban water management with integrated smart metering solutions. Massive amounts of water consumption data from the end users can be collected and produce insightful information creating potential benefits for operational managers as well as for the end users.



Figure: Smart meters installed in the apartments

The case study analysed refers to a data set containing high frequency end user water consumption data from rental 79 apartments in Södertälje, Sweden. The data set was analysed in order to see what possible information that could be extracted and interpreted based on an Exploratory Data Analysis (EDA).

Furthermore, an interview with the operational manager of the buildings under study as well as a literature review have been carried out in order to understand how the gathered data is used today and to which contexts it could be extrapolated to provide potential benefits at a building level.

Through analysis, variations over time, water consumption patterns and excessive water users have been identified as well as a leak identification process. Even more challenging than to make meaning of the data is to trigger actions, decisions and measures based on the data analysis. The unveiled information could be applied for an improved operational building management, to empower the customers, for business and campaign opportunities as well as for an integrated decision support system.

To summarize, it is concluded that the usage of smart water metering data holds an untapped opportunity to save water, energy as well as money. In the drive towards a more sustainable and smarter city, smart water meter data from end users have the potential to enable smarter building management as well as smarter water services.



## 4.4. Forecasting Domestic Water Consumption from Smart Meter Readings

(Source: Forecasting Domestic Water Consumption from Smart Meter Readings using Statistical Methods and Artificial Neural Networks, David Walkera, Enrico Creacoa, Lydia Vamvakeridou-Lyroudiaa, Raziye Farmania, Zoran Kapelana, Dragan Savic, 13th Computer Control for Water Industry Conference, CCWI 2015).

Forecasting domestic water use is of vital importance for water utility companies, while the rising prevalence of smart water meters, collecting high resolution data from individual users, provides a large corpus of data on which predictive models can be based.

The iWIDGET project has recently begun collecting large volumes of meter readings, measuring water consumption at 15 minute intervals for domestic properties in locations throughout Europe. In this work, data from a pilot case study in Greece were used to develop a model capable of forecasting water usage at hourly resolution for the households participating in the iWIDGET project. Predictions at this frequency are useful, for example, for leakage detection.

Artificial neural networks (ANNs) are known to be adept at modelling nonlinear relationships, and have been used for predicting domestic water consumption, as well as being applied in a range of hydroinformatics settings. ANN training is conducted with an evolutionary algorithm.

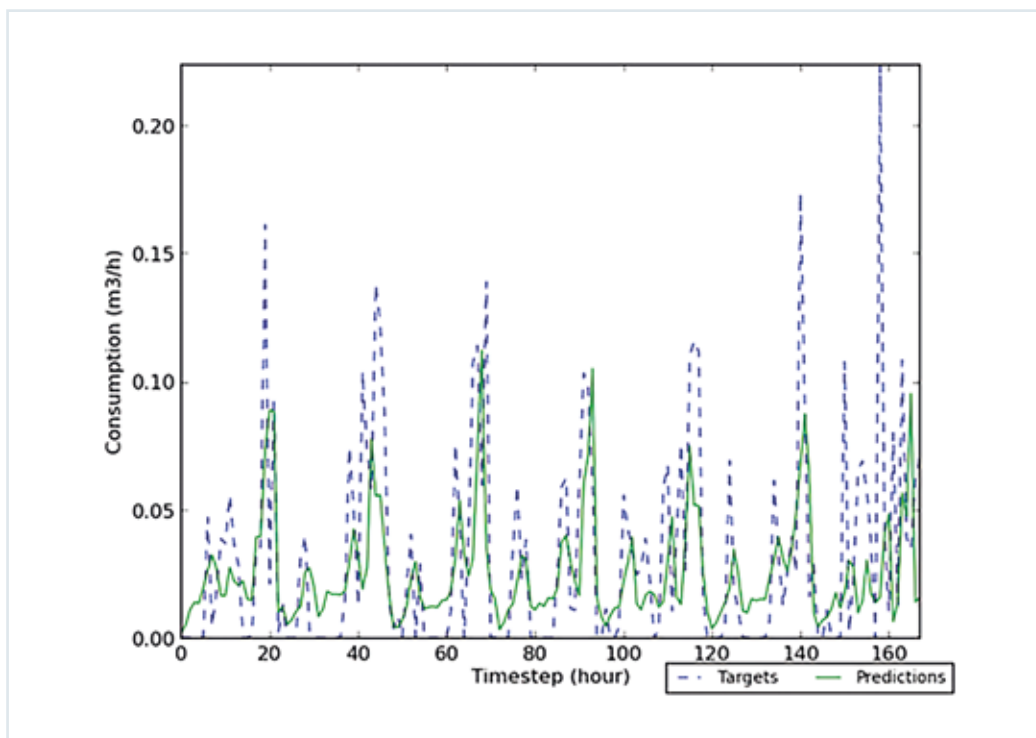

Figure: A comparison of the prediction of the model and the real values of water consumption

The model showed ability to predict domestic water consumption, but suffer from a lack of accuracy to predict unexpected peaks. Future work will explore avenues to address this issue, exploring the extensions to the neural network approach, while also examining the efficacy of statistic modelling approaches.



## Overview table: Monitoring the water cycle in Smart Governance

### General Objective

- Recycle and reuse wastewater
- Increase efficiency in water use and distribution
- Guarantee good quality of water bodies
- Retain water as long as possible on site
- Promote multiple water use and water sustainability

### Specific Goals

- Promote data driven policy making
- Provide data on projects results to investors

### Standard approach difficulties

- Lack of proper devices that monitor water cycle
- Difficult in collecting homogeneous data thus the difficulties in proper analysis useful for stakeholders and policy makers.
- Lack of integrated approach

### Smart Governance approaches

The standard approach could be enhanced by

- introducing more stakeholder engagement,
- adopting innovative technologies and
- including monitoring programs within a wider environmental and social sustainability monitoring strategy

### Citizen engagement and communication strategies

- Simple water quality testing equipment (e.g. hydrogen sulphide, H<sub>2</sub>S, tests) could be supplied to communities so they can self-test their water
- Providing good education on maintaining water facilities and monitoring devices.

### Sources and further examples

Smart Approach of Harvesting Rainwater and Monitoring Using IoT, V S P Chandrika Kota et al., 2020 and “Smart city rain water harvesting (IOT) techniques by J.Vinoj and Dr.S. Gavaskar, 2018

Luke Mosley, Water quality of rainwater harvesting systems, 2005 SOPAC Miscellaneous Report 579

Turning Smart Water Meter Data Into Useful Information A case study on rental apartments in Södertälje , Philip Dahlström, Anna Söderberg, 2017

Forecasting Domestic Water Consumption from Smart Meter Readings using Statistical Methods and Artificial Neural Networks, David Walkera, Enrico Creacoa, Lydia Vamvakeridou-Lyroudiaa, Raziye Farmania, Zoran Kapelana, Dragan Savic, 13th Computer Control for Water Industry Conference, CCWI 2015



## 5. Incentives and Financial support (for recycled water project & construction of harvesting systems)

Water management interventions are very inter-disciplinary and produce benefits in many dimension of our world. The financing of water projects can be obtained from different sources, but the most promising are those related to the wider theme of climate change and the Sustainable Development Goals, SDGs.

The “United Nations World Water Development Report 2020: Water and Climate Change” reports that the growing interest in climate finance, and its variety of sources, instruments and destinations, makes it an interesting opportunity to receive funds for water projects related to the SDG 6, “Ensure availability and sustainable management of water and sanitation for all”.

Climate finance architecture is complex and evolving. There are multiple mechanisms, institutions, programmes and activities at various scales. Potential sources of growth in climate finance will be national institutions financing Nationally Determined Contributions (NDCs) and Green Climate Fund. Green banks, green bonds, subnational climate funds and public-private partnerships are other emerging areas to watch for future climate financing opportunities.

### 5.1. Climate finance: financial and economic considerations

(Main source: United Nations World Water Development Report 2020: Water and Climate Change)

Water resources management is currently underfinanced and in need of greater attention from governments. Climate change threatens water resources management, increases the risk of weather-related events, and affects the availability and quality of water and sanitation services around the world. However, it also presents an opportunity: to leverage climate finance mechanisms to provide additional funding to improve water management, and by doing so improve safe water and sanitation access through actions that also mitigate and/or increase resilience to climate change, often providing other co-benefits at the same time.

Connecting water to climate change could allow the international community to leverage additional resources to address the wide overlap between climate and water challenges, and thus improve the outlook of meeting the overall water management goals as outlined in Sustainable Development Goal (SDG) 6.

Ignoring climate risks and failing to increase water investments would clearly threaten the chances of meeting SDG 6, and would have wider reverberations as well. Since water is a critical factor of production in many sectors, increasing scarcity and vulnerability of water supplies would threaten livelihoods around the globe. Water-related losses could send some regions “into sustained negative growth,” with growth rates in some regions at risk of declining by 6% of gross domestic product by 2050 (World Bank, 2016a, p. vi). These changes will burden poor households the most. Thus, when considering the cost of financing water infrastructure, it is also necessary to evaluate “the counterfactual risk of not financing infrastructure” (WWC, 2018, p. 15). Preventive action therefore could have a positive return on investments in the form of avoided future losses while also improving current water management practices. However, for this to happen, water managers will need to



## Thematic Catalogue 3

properly incorporate planning and investment design in the analytical methods that allow for the proper identification of climatic and non-climatic risks and uncertainties. It is therefore essential to prioritize adaptation strategies and investments that can manage those risks and uncertainties. If current water financing is inadequate and increasing water financing offers considerable potential benefits, then what can be done to increase access to financing and realize those benefits? While water management requires more attention from traditional sources such as government and development finance, the answer may also lie in adding climate finance. The Climate Policy Initiative (CPI) reports that climate finance has been increasing in recent years, from US\$360 billion in 2012 to an estimated US\$510-530 billion in 2017. Out of the US\$455 billion invested in 2016, US\$11 billion went to water and wastewater management in climate adaptation, and US\$0.7 billion to water and wastewater management in climate mitigation. This means only 2.6% of 2016's climate finance went directly to water management, even if this may mask water-related projects in other sectors, such as disaster risk management; agriculture, forestry, land use, and natural resource management; coastal protection; and other sectors (CPI, 2018). Proponents of water projects could aim to increase the water sector's share of climate finance and emphasize water's ties to other climate-related sectors in order to ensure greater funding for water management.

Responding to climate change involves two possible approaches: reducing and stabilizing the levels of greenhouse gases in the atmosphere ("mitigation") and/or adapting to the climate change already in the pipeline ("adaptation").

Two promising trends will increasingly help water projects access climate finance.

The first is the increasing recognition of the mitigation potential within water and sanitation projects. This trend could be particularly advantageous, as mitigation made up 93.8% of climate financing in 2016, but water projects consisted of a fraction of 1% of that sum (CPI, 2018). There may be a large untapped potential in intentionally linking water and mitigation, attracting increased financing to water management goals. Increasingly, however, the mitigation potential of water management options is being recognized. Water and wastewater utilities can have large energy footprints, so there is significant mitigation potential in increasing both water and energy efficiency, as well as in recovering energy, water and nutrients from wastewater streams.

Other solutions with benefits in both water and climate include regenerative agriculture, green infrastructure, ecosystem restoration and other innovative initiatives such as 'floatovoltaics' - solar panels that float on reservoirs and provide clean energy while preventing water loss through evaporation.

The second trend is an increasing emphasis on financing climate adaptation. Climate finance is typically heavily weighted toward mitigation rather than adaptation, but recently this has begun to change.

The Green Climate Fund has a target of financing 50% mitigation and 50% adaptation, the World Bank has dedicated US\$50 billion to adaptation over the next five years, and the criteria for certifying climate bonds include resilience investments (Tall and Brandon, 2019). With these developments, water practitioners who integrate climate change analysis into their project planning will increase their chances of accessing climate finance, be it for mitigation or adaptation. Disaster risk management made up a little less than 14% of 2016's climate financing for adaptation, about US\$3 billion (CPI, 2018).





### 5.1.1. Types of climate investments for water projects

#### No-regret and low-regret investments

Climate impacts are not always certain, especially at the micro-level. Scientific knowledge and predictive climate modelling continue to improve, but decisions must be made in the meantime to help communities prepare and adapt. No-regret and low-regret investments are a response to this uncertainty.

No-regret investments are investments that are beneficial regardless of the climate impacts - they would provide benefits even in the absence of climate change, as well as across a range of potential climate hazards. Low-regret investments “may incur an additional cost to offset climate change risks, but these costs are small in comparison to the benefits of avoiding future costs” (GWP-Caribbean/CCCCC, 2014, p. 1). Such projects increase resilience. They also tend to bring co-benefits to multiple sectors and stakeholders, have built-in flexibility for future adjustments, and minimize tradeoffs.

No-regret interventions for water and climate change could include rainwater harvesting, sustainable groundwater management, micro-irrigation technologies, wastewater reuse and improved water storage (Vermeulen et al., 2013). Any intervention that improves efficiency and conservation, by reducing leaks for example, is also generally considered a low- or no-regret choice. These interventions also tie into both mitigation and adaptation, since efficiency and conservation both reduce energy use and increase water availability.

#### Results-based climate financing

Results-based climate financing is a type of investment in which “funds are disbursed by an investor or donor to a recipient upon the achievement of a pre-agreed set of [mitigation or adaptation] results, with achievement of these results being subject to independent verification” (World Bank, 2017d, p. 1). It can be used on its own or together with upfront financing, and it can be deployed at different scales and with different project entities.

There are several different ways to approach results-based climate financing, but as a modality it has the potential to improve monitoring, reporting and verification capacity, strengthen domestic institutions, mobilize the private sector, and create or strengthen markets to produce climate results. Most results based investments thus far have been made in climate mitigation projects, since carbon emissions are a well-defined and measurable indicator, but this type of financing can also be used for climate adaptation goals. In this regard, new results-based climate mechanisms can target nature-based solutions (NBS), where the funding gap is expected to be the greatest (WWC/ GWP, 2018). Projects that find synergies between water management goals and climate mitigation or adaptation can take advantage of this promising financing modality.

### 5.1.2. Multilateral climate finance for water

Three multilateral funding institutions exist specifically for financing climate and environmental projects: The Green Climate Fund, the Global Environment Facility and the Adaptation Fund. In addition, development banks have begun to prioritize climate change and integrate it into their development activities, and some have climate-specific funds. Water managers could look to these funds, which in 2016 provided US\$51 billion, or 11% of all climate financing (CPI, 2018).



## Thematic Catalogue 3

### The Green Climate Fund

The Green Climate Fund was established as a financing mechanism of the Paris Agreement, to help developing countries mitigate and adapt to climate change. As of 2019, it has received US\$10.3 billion in pledges, out of the goal of US\$100 billion per year, and the Fund has committed about US\$5 billion of that to approved climate projects (Box 12.4). Though most if not all their results areas and investment priorities involve water management, the clearest result area for water is health, food and water security, which falls under adaptation (Green Climate Fund, n.d.).

### The Global Environment Facility

The Global Environment Facility provides grants for several types of environmental projects, including climate change mitigation and adaptation. It also serves as the financial mechanism for the United Nations Framework Convention on Climate Change (UNFCCC). Since its founding in 1992, it has funded almost 1,000 climate mitigation projects and 330 adaptation projects. A recent project with both climate and water benefits “helped generate tools to assess the effects of glacier retreat and integrate climate change considerations into strategic planning”, and “addressed pressing development issues related to water supply or irrigation in Bolivia, Ecuador and Peru” (GEF, n.d.).

### The Adaptation Fund

The Adaptation Fund was originally set up under the Kyoto Protocol and finances projects that help developing countries adapt to climate change. It has supported over 80 adaptation projects since 2010 and has committed US\$564 million to climate adaptation and resilience activities (Adaptation Fund, 2019). During the 24th United Nations Climate Change Conference (COP24) in December 2018, country Parties decided that the Adaptation Fund would serve the Paris Agreement starting in 2019. Water management is one of the Adaptation Fund’s project sectors, and it accepts transboundary project proposals.

### Development banks

Climate change is a threat to development and anti-poverty goals, while acting on climate can bring development and equity co-benefits. For those reasons, at COP24 the World Bank committed to doubling its climate investments to US\$200 billion from 2021-2025 to support countries taking ambitious climate action (World Bank, 2018b). Of that sum, US\$50 billion will be dedicated to adaptation finance. The World Bank aligns its internal processes and metrics to consider climate risks and opportunities, and evaluates its operations for climate impacts and co-benefits. So, it is worthwhile for water managers hoping to access World Bank funds to mainstream climate mitigation and/or adaptation into their plans (World Bank/IFC/MIGA, 2016). Several multilateral development banks have formulated guidelines to mainstream climate analysis into planning and investment design. Furthermore, over the past few years, multilateral development banks have also formulated guidance notes to help operational teams move towards climate-smart portfolios of investments and to maximize the climate adaptation and mitigation results of each investment. Regional development banks also have climate change initiatives that water practitioners could tap into. The members of the International Development Finance Club, a global network of 23 national and regional development banks, committed US\$196 billion to climate finance in 2017, primarily for climate mitigation. Of the US\$10 billion allocated to climate adaptation, 58% went to water ‘preservation’, which includes catchment management, rainwater harvesting, and rehabbing water distribution networks. The International Development Club’s provided 72% of its green finance commitments (including climate and other environmental financing) to the East Asia and Pacific region, while the European Union (EU) received 14% of green finance, and Latin America and the Caribbean received 6%. Green financing commitments to Eastern Europe and Central Asia, the Middle East and North Africa, South Asia, and Sub-Saharan Africa were smaller, at 1-3% per region (IDFC, 2018).



### 5.1.3. National climate finance for water

#### Bilateral climate finance

Climate financing initiatives or development agencies with climate objectives exist in many countries and regions, including the EU, Germany, Japan, the Nordic countries, Switzerland, the United Kingdom, The United Arab Emirates, the United States of America and others.

As is the trend with most climate financiers, bilateral sources primarily financed mitigation (66% of bilateral finance in 2017) over adaptation (21%), with cross-cutting activities more common among bilateral sources (14% in 2017) than multilateral ones (4%) (OECD, 2018).

#### National and subnational climate finance

As each country's nationally determined contribution (NDC) to the Paris Agreement becomes mainstreamed into government spending plans, domestic expenditures by national governments may be a growing source of climate finance. The UNFCCC estimates that US\$232 billion of domestic public finance was spent per year in 2015 and 2016, with US\$157 billion per year in developing countries and US\$75 billion in developed countries. However, "comprehensive data on domestic climate expenditures are not readily available, nor are such data collected regularly or using a consistent methodology" (UNFCCC, 2018, p. 62). If water managers can align their projects to their country's NDCs, they may be able to access these domestic sources of climate financing. But without comprehensive data, it is difficult to draw conclusions that could guide water and sanitation financing efforts. National domestic finance institutions may also offer climate financing. In Latin America and the Caribbean, national development banks such as the Brazilian Development Bank "are already the single largest source of public climate finance in domestic markets" (NRDC, 2017, p. 4). Several countries and subnational jurisdictions have begun establishing green investment banks, also known as green banks, in recent years. Green banks "are publicly capitalized, domestically focused, specialist financial institutions specifically established to crowd in private capital" to climate and environmental investments (NRDC, 2017, p. 1). While green banks were initially established almost exclusively in OECD countries, current efforts are expanding the model to countries in Africa, Asia and Latin America (Green Bank Network, 2018). As green banks begin to proliferate, water project managers may wish to monitor this area for future financing opportunities.

#### Private sector finance

Private sector finance accounted for a majority (54%, or US\$230 billion) of climate finance flows in 2016, the bulk of which came from project developers (CPI, 2018). Other sources of private finance could include carbon markets, foreign direct investment, insurance, or commercial financial institutions. An estimated US\$15.7 billion of private financing was mobilized by multilateral development banks (UNFCCC, 2018). But the sources and destinations of private financing are not well documented. One emerging source of private financing that may be useful to water practitioners is the green bond market. Pioneered in 2007, green bonds and climate bonds offer "significant global opportunities to mobilize capital at scale for low carbon, climate resilient infrastructure and development efforts" (World Bank, 2018c). The green bond market has grown rapidly, from US\$3.4 billion in 2012 to US\$168 billion in 2018. The Climate Bonds Standard, a labelling scheme akin to FairTrade certification, has released Water Infrastructure Criteria to certify water-related bonds for low-carbon and climate-resilient water management standards (Climate Bonds Initiative, 2018). In 2018, the Global Green Bond Partnership was launched to accelerate the issuance of green bonds. The Partnership plans to develop toolkits for companies, subnational entities and other groups that are interested in issuing green bonds, so water managers can take advantage of those resource as they come out (World Bank, 2018c). There are also other types of environmental bonds emerging, such as catastrophe bonds, environmental impact bonds and resilience bonds.



### Public-private partnerships

Climate-smart public-private partnerships are another potential way to meet financing needs for climate-resilient water infrastructure investment. The Public-Private Infrastructure Advisory Facility (PPIAF) has defined climate change as a strategic priority for fiscal years 2018-2022. The Facility will focus on climate change initiatives and embed climate activities in its technical assistance and knowledge work (Suriyagoda, 2017). The PPIAF Climate Change Trust Fund for Infrastructure will promote climate-smart models and enabling environments for climate-smart public-private partnerships. Water supply and sanitation is one of the sectors included in the Fund's planned programmatic initiatives. While climate change does not currently play a significant role in public-private partnerships, the World Bank and PPIAF's mainstreaming of climate change into their initiatives and knowledge activities will define future infrastructure trends and is another area for water managers to watch.

### Blended finance

Blended finance “incorporates different types of financing into a single project or fund” (World Bank, 2019, p. 24). Blended finance can have a crowding-in effect by using concessional loans (i.e. loans with below-market rates) or grants to make projects more attractive for traditional sources of capital, and it can help project proponents better manage risks. Several development banks, climate funds and bilateral funds have begun using this paradigm to attract commercial finance and support projects that have a potentially high impact but must overcome barriers to be commercially viable. The bankability criteria of the Green Climate Fund and other prominent sources of climate financing tend to screen out smaller-scale, subnational-level projects. To address this financing gap, R20 Regions of Climate Action and BlueOrchard Finance are, as of early 2019, in the process of setting up a Subnational Climate Fund for Africa. The Fund will leverage blended finance to fund subnational infrastructure projects with positive climate impacts in emerging markets (R20 for Climate Action, 2018). For water project developers, especially in Africa, this may be a financing source to watch for future opportunities. Special attention must be paid to low-income countries, because “countries that have the greatest need for investment are often perceived as risky and as having governance issues”. Only 3.6% of the private finance mobilized by using blended finance in 2012-2015 flowed to low-income countries (Hedger, 2018b, p. 6).

## 5.2. Financial instruments for Municipal governments

(Main source: Addressing climate change in cities - Policy instruments to promote urban nature-based solutions”, 2020 by the Ecologic Institute and Sendzimir Foundation)

“Addressing climate change in cities - Policy instruments to promote urban nature-based solutions”, 2020 by the Ecologic Institute and Sendzimir Foundation provides an overview of instruments that can be applied by municipal governments to finance or promote the wider uptake of NBS in urban areas.

Three financial instruments for municipal governments are described: Tax and fees relief, Subsidies and Participatory budgets.

### 5.2.1. Tax and fees relief

Tax incentives and fee reductions are most commonly applied to promote the installation of sustainable urban drainage systems to increase on-site infiltration, evapotranspiration or stormwater reuse and reduce inflows into municipal stormwater infrastructure.



## Thematic Catalogue 3

These financial instruments incentivize real estate owners to install NBS on their property promote the creation or maintenance of urban greenery.

Alternatively, to promote the implementation of green infrastructure, a municipality can introduce charges on the use of “grey” infrastructure, but the introduction of new charges can be an unpopular solution.

Tax incentives and fee reductions must carefully balance:

- the public benefits of implemented NBS such as decreased demand on the municipal stormwater infrastructure, decreased flood risk, or decreased air pollution.
- the advantage of property owners to reduce the size of “grey” surface area.

A tax incentive or fee reduction will not act as intended if the cost of installing NBS outweighs the benefits and savings generated.

Municipalities might need to consider awareness-raising campaigns to highlight the long-term saving opportunities and provide guarantees that foreseen incentives and reductions will continue for several years.

Monitoring the installation and functioning of the NBS system is fundamental to confirm or rearrange the financial instrument.

### 5.2.2. Subsidies

Subsidies are used to trigger private investment in NBS, most commonly for NBS attached to private properties like green roofs or sustainable urban drainage systems. As NBS bring benefits to the wider public and not just to the investor or direct user, subsidies serve as payment for delivering the public benefits of the private investment.

Benefits of subsidies for NBS implementation:

- promoting private investment on private properties,
- easing the burden of high initial investment, relying on the high return of investment in the long-term,
- mitigating the perceived risk associated with NBS and trigger investment in innovative green solutions.
- payments for the provisioning of public goods,
- promoting wide-scale uptake of specific solutions to achieve city-wide benefits.

To ensure wide NBS uptake, it is essential that the size of subsidy is attractive for investors and appropriately compensates for the faced uncertainty and higher initial costs compared to grey solutions. A successful subsidy programme should be accompanied by a public education and outreach campaign, including information on potential savings at the property level to promote awareness and uptake of the subsidy. Standardisation of subsidies, clarification of requirements and simplification of procedures have been shown to encourage more applications.

NBS can have higher long-term maintenance costs than grey solutions. In such cases, long-term funding (e.g. in the form of tax cuts) may be needed to accompany a subsidy policy and ensure its success.



### 5.2.3. Participatory budgets

Participatory budgets is a process where citizens help decisions about how a public budget is spent. A participatory budget can be dedicated to urban greenery projects, NBS or climate protection. This may also raise awareness amongst citizens about the specific issue being addressed and increase knowledge about benefits generated by NBS in the process.

Raising awareness and stimulating citizen engagement can be the key motivations behind participatory budget dedicated to urban greenery projects, NBS or climate protection. The participatory budget can act as a catalyst, encouraging private sector investment in such projects and attract additional private sources for adaptation and mitigation.

Potential projects include, for example, tree planting to support heat reduction, water capture and storage and cycle lanes are part of the Lisbon Participatory budget.

Benefits of participatory budgets for NBS implementation are:

- **Generating new ideas and capturing local knowledge:** participatory budgeting allows new ideas proposed by citizens to be captured and acted upon, as a valuable addition to the expert knowledge of the administrations. Citizens can bring an awareness of specific local problems that can be addressed with NBS projects in their neighbourhoods and can use their knowledge and experience to propose solutions that the municipal experts may not be familiar with. Citizen participation can also help the municipal administration to prioritise measures in cases where there are limited funds.
- **Fostering acceptance:** well-informed citizens that are actively engaged in planning and decision-making process have an opportunity to better understand the benefits of the solutions proposed, which can be particularly useful when introducing new, innovative NBS. This can ensure an increased sense of ownership and can inspire citizens to take part in the maintenance of newly realised projects.
- **Understanding of budgetary constraints:** Participatory budgets create a better understanding of constraints to municipal budget, helping citizens understand that only a limited number of projects can be realised at any given time.
- **Mobilising private investment in NBS:** depending on their design, participatory budgets can allow public resources to be channelled into integrated projects, helping secure private resources and contributions from local entrepreneurs and developers and unlocking funding that would otherwise not have been used for NBS, without the additional public funding that became available.

Checking that the NBS which are proposed through such participatory process conform to certain minimum standards can ensure their effectiveness in fulfilling specific goals, such as increasing the accessibility of green spaces to the urban population. This can be realised by, for example, creating a municipality-approved catalogue of NBS which are eligible for funding, including their technical specifications. One example of such guide is the Catalogue of urban NBS (Iwaszuk et al., 2019), a publication produced to accompany this guidance document. Such an approach will, however, limit the scope of ideas that can be freely proposed by citizens to those included in the catalogue.



### 5.3. Economic incentives for water consumption reduction: case study of the city of São Paulo

(Source: Economic incentives for water consumption reduction: case study of the city of São Paulo, Brazil. Water Policy 21 (2019). Cláudia Orsini M. de Sousa and Nuno M. M. Dias Fouto)

The study de Sousa and Fouto (2019) has demonstrated that the use of economic incentives was effective in reducing water consumption in the city of São Paulo, Brazil. Thus, the goal of preserving water resources in a scarcity situation was achieved.

The strategy used by São Paulo Water Agency combined two different kinds of economic incentives:

- a bonus for customers who saved water and
- a contingency tariff for customers who increased their water consumption during the crisis period.

The results of the econometric analysis support the results of the explanatory analysis:

- the implementation of the bonus was effective in encouraging water consumption reduction and more efficient than the contingency tariff,
- consumption reduction was more meaningful in districts that used water originating from springs under more critical conditions but was adopted by citizens from all analysed districts.

In addition, the econometric analysis also demonstrated that income was relevant for water demand reduction both when we considered a continuous variable and when we considered a binary variable (in ranges). Districts in higher social classes were more willing to reduce consumption.

Despite the importance of an economic incentive, a considerable part of the population in São Paulo did not wait for the implementation of the bonus to start saving water in their households.

Monitoring was not lasting enough to confirm the influence of the socio-economic variables: the lack of information is an obstacle to a more detailed assessment. Nevertheless, the results of studies like that in São Paulo may be used as a subsidy for government decision-making, in situations of water scarcity. Actions that prevent water scarcity are a priority, but the strategy implemented in São Paulo may be useful, especially when considering that prevention actions are sometimes difficult to implement, especially in underdeveloped countries.



## Overview table: Incentives and Financial support in Smart Governance

### General Objective

- Recycle and reuse wastewater
- Increase efficiency in water use and distribution
- Guarantee good quality of water bodies
- Retain water as long as possible on site
- Promote multiple water use and water sustainability
- Preserve flow in water bodies

### Standard approach difficulties

Water resources management is currently underfinanced and in need of greater attention from governments.

Without proper measurements of results it's more difficult to obtain financing.

### Smart Governance approaches

Funding can come from sources not strictly dedicated to water (e.g. different monothematic funding programs can be reached for NBS, such as air quality, energy, climate).

“A reliable monitoring system of the progress of the intervention and results can attract financing”.

“Community funding/crowdfunding approach can be pursued for specific local intervention”.

### Citizen engagement and communication strategies

Citizens should be involved in designing incentives and economic strategies that reduce water consumption.

Economic incentives are effective to reduce water consumption and improve citizens behaviour in water use.

Participatory budget involve citizens in public decision and raise awareness on the cost of water infrastructures and water management.

Innovative financing schemes that involve citizens should be investigated and tested.

### Sources and further examples

United Nations World Water Development Report 2020: Water and Climate Change.

Addressing climate change in cities - Policy instruments to promote urban nature-based solutions”, 2020 by the Ecologic Institute and Sendzimir Foundation.

European Commission, Water Reuse Systemk, Management Manual, AQUAREC, 2006.

<https://energy-cities.eu/financing-opportunities-for-sustainable-energy-climate-action-plans/>

Economic incentives for water consumption reduction: case study of the city of São Paulo, Brazil. Water Policy 21 (2019). Cláudia Orsini M. de Sousa and Nuno M. M. Dias Fouto





## 6. Education programmes

(Source: <https://en.unesco.org/themes/water-security/hydrology/water-education>)

Water education at all levels needs to be improved to meet the water challenges. Water education must go beyond the teaching of hydrological sciences and be multidisciplinary. This approach includes advancing scientific knowledge through the training of scientists as well as increasing knowledge on water issues through courses aimed at water professionals and decision-makers. Water education should also reach out to media professionals so that they can communicate water issues accurately and effectively. The work will include community education strategies to promote communitywide water conservation, as well as enhance skills in local co-management of water resources. Several projects such as CWC promote water education and provide sources that can be useful for education at different levels.

A wide water education programme is proposed by UNESCO. The methodology proposed by UNESCO can be inspiring and translated for local purposes.

UNESCO provide support to water related education programmes: Water-related centres (<https://en.unesco.org/themes/water-security/centres>) play an important role in this endeavour, in addition to the network of universities, institutes and research facilities linked to the Intergovernmental Hydrological Programme's other themes, projects and initiatives. Case studies of leading practices in sustainable water management will be developed to maintain and expand the training of technicians in water-related fields.

Five focal Areas are supported by the UNESCO Educational programme:

1. Enhancing tertiary water education and professional capabilities in the water sector
2. Addressing vocational education and training of water technicians
3. Water education for children and youth
4. Promoting awareness of water issues through informal water education
5. Education for trans boundary water cooperation and governance

### 6.1. Enhancing tertiary water education and professional capabilities in the water sector

Human capacities and expertise of the water sector and related areas must be ensured to guarantee universal access to freshwater and address complex challenges linked to social, economic, climatic, and other factors at local, regional and global levels.

#### Objectives

- Support the enhancement of tertiary water education capacities, particularly in developing countries.
- Promote and assist the development of interdisciplinary and multidisciplinary curricula and research initiatives linked to water-related programs in higher education and research institutions.
- Strengthen collaboration between UNESCO-IHE Institute for Water Education, the UNESCO Category II Water Centres and UNESCO water-related Chairs, other UN system agencies and programmes, and existing international water-related education programmes.
- Promote and support strategies and actions for continuous professional development of water



scientists, engineers, managers and policy makers in the water sector.

- Develop interdisciplinary materials, such as guidelines, briefing papers, prototype professional development programmes and case studies connected with water education for water security, linked to the implementation of other Intergovernmental Hydrological Programme themes and programmes.

## 6.2. Addressing vocational education and training of water technicians

Intergovernmental Hydrological Programme will aim to maintain and expand the training of technicians in water-related fields, such as hydrometeorological monitoring, irrigation systems, sanitation, and water supply systems. An important component of this focal area will be to survey and prepare case studies with examples of leading practices in sustainable integrated water management for the training of water technicians.

### Objectives

- Support specific initiatives in developing Member States to sustain and improve water-related vocational education.
- Survey, prepare and analyze case studies of examples of leading practices in sustainable water management in the training of water technicians and support the preparation of guidelines and briefing papers based on them.
- Develop efforts within UNESCO and in partnership with other UN system agencies and programmes to maintain and expand the training of technicians in water-related fields.

## 6.3. Water education for children and youth

Water education should be part of childer and youth training. Beyond formal education systems, other initiatives will be considered, such as the development of water-related activities in children's eco-clubs, sports clubs, and explorer groups. To this aim it is required to improve the capacity of teachers and informal educators to better understand water issues at the local, regional and global scales, and to commit to a water ethic.

### Objectives

- Develop capacity of teachers and informal educators on water issues at the local, regional and global scales.
- Support and guide the development of improved tools for the teaching of water issues.
- Guide and provide technical support to national/regional demonstration projects and the development of prototype materials at national/regional levels in select Member States/regions.
- Provide technical assistance for the development of interdisciplinary support materials, such as guidelines, briefing papers, and case studies on leading practices in K-12 water education, and curriculum development on water resources, in coordination with other UNESCO Sectors.
- Provide games related to water to increase students engagement.



## 6.4. Promoting awareness of water issues through informal water education

Communities need to have the appropriate knowledge and understanding of their watershed, the natural, social, cultural conditions, as well as policies and regulations, economic trends and development opportunities, to be involved in water management and conservation. They will also be more actively involved if they are organized. IHP will develop water education activities for communities and will partner with IHP National Committees.

Mass media professionals can play an important role in increasing awareness on water-related problems and issues. Yet limited efforts have been made to educate them on water issues, and so reports are mainly on extreme water-related situations, when preventive measures or actions relative to disasters, conflicts, contamination, loss of life and natural resources are no longer applicable. If journalists, bloggers, radio, television, film, and other media professionals understand the importance of local, regional and global water issues, this will be an effective mechanism for increasing overall public awareness.

### Objectives

- Develop and promote community education strategies related to water issues (state of the resource, conservation, co-management, among others).
- Provide technical assistance for the development of interdisciplinary support materials, such as guidelines, briefing papers, and case studies on leading practices in water education for communities.
- Provide technical assistance for the development of interdisciplinary support materials, such as guidelines, briefing papers, and case studies on leading practices in water education for mass and community media professionals.
- Engage leading mass media professionals in awareness raising campaigns and programs.

## 6.5. Education for transboundary water cooperation and governance

Since the majority of large basins and aquifers in the world are shared between two or more countries, the management and conservation of water resources needs to take place through negotiations and the establishment of agreements. However, very few institutions around the world have specialized courses or projects on water negotiation for cooperation. IHP supports the development of educational initiatives that support transboundary water cooperation and negotiation. PCCP (From Potential Conflict to Cooperation Potential), is a long-term IHP project which aims to compile and develop wise practices and guidance tools on shared water resources management and negotiation. New capacity building tools, guidelines, curricula and case studies to support Member States in their ongoing transboundary management and negotiations will be developed in this phase.

### Objectives

- Provide technical assistance for the development of interdisciplinary support materials, such as guidelines, briefing papers, and case studies on leading practices in education and capacity building for transboundary water cooperation.
- Improve Member States' cooperation and mutual understanding, strengthen capacities and develop agreements for the sustainable management of transboundary water through capacity building activities at all levels.
- Assist in the development of curricula and research on transboundary water cooperation in higher education institutions.



## 6.6. Smart devices and gamification

(Main source: Gamification for water utilities, Isabel Micheel, Jasminko Novak | European Institute for Participatory Media, Berlin, Piero Fraternali | Politecnico di Milano)

Gamification, with the related use of smart devices, can be an educational tool especially in rising citizens awareness and promote behavioural change and can be defined as “The use of game design techniques and game mechanics to enhance non-game contexts” (S. Deterding, M. Sicart, L. Nacke, K. O’Hara, and D. Dixon).

Gamification make use of game-like elements to trigger specific behaviour in citizens. The motivation to complete tasks can be achieved by use of:

- Points or Player Scores, numerical values that represents a measure of the skill of a user.
- A Leader board, an ordered list of players based on the scores they have obtained in a specific game or system.
- An Achievement, a set of tasks, defined by a designer, for the user to fulfil so to achieve a milestone and track the progress in a system.
- A Badge, an artefact associated to the completion of an achievement and given to a player after its completion, or, in gaming terms, after “unlocking the achievement”.

Gamification can be part of a wider communication programme to be more effective and reduce the potential risk:

- Short term effects
- Not every process or every activity is equally suitable for gamification
- Sometimes processes may have to be restructured to be gamified
- Gamification alone is often not efficient enough

European project already tested the use of gamification within the water matter such as, WATER-NOMICS project, WISDOM project and Smarth2O project.

In the following box is shown an example of Gamification for rising sustainable behaviour within the H2020 project Sharing Cities.



# SharingMi, promoting green behavioural change by gamification



SharingMi (<https://www.sharingmi.it/>) is the greenApes community of people living in Milan, managed by Poliedra - Politecnico di Milano and supported by Milano Municipality.

SharingMi was launched in 2019 as a product of the Horizon 2020 Sharing Cities Project (<http://www.sharingcities.eu/>), concerning the task of creating a Digital Social Market with the aim to push citizens towards more sustainable behaviours, rewarding them with incentives and prizes for their green every day's actions and habits, and thus giving a contribution to the local environment.

Becoming users of SharingMi, citizens can access a community of people that share stories, certified positive behaviours (through integrated third parties' sensors, apps and services, GPS check-in, secret codes) and participate in special «challenges» and events to improve their sustainable lifestyles. Users can inspire and be inspired by others, creating direct interactions, sharing and exchanging their opinions (throughout claps - greenApes like, comments and private messages). Posting and interacting with others make users earn BankoNuts (points) that are redeemable in incentives, services and prizes offered by local partners sharing the same eco-values.

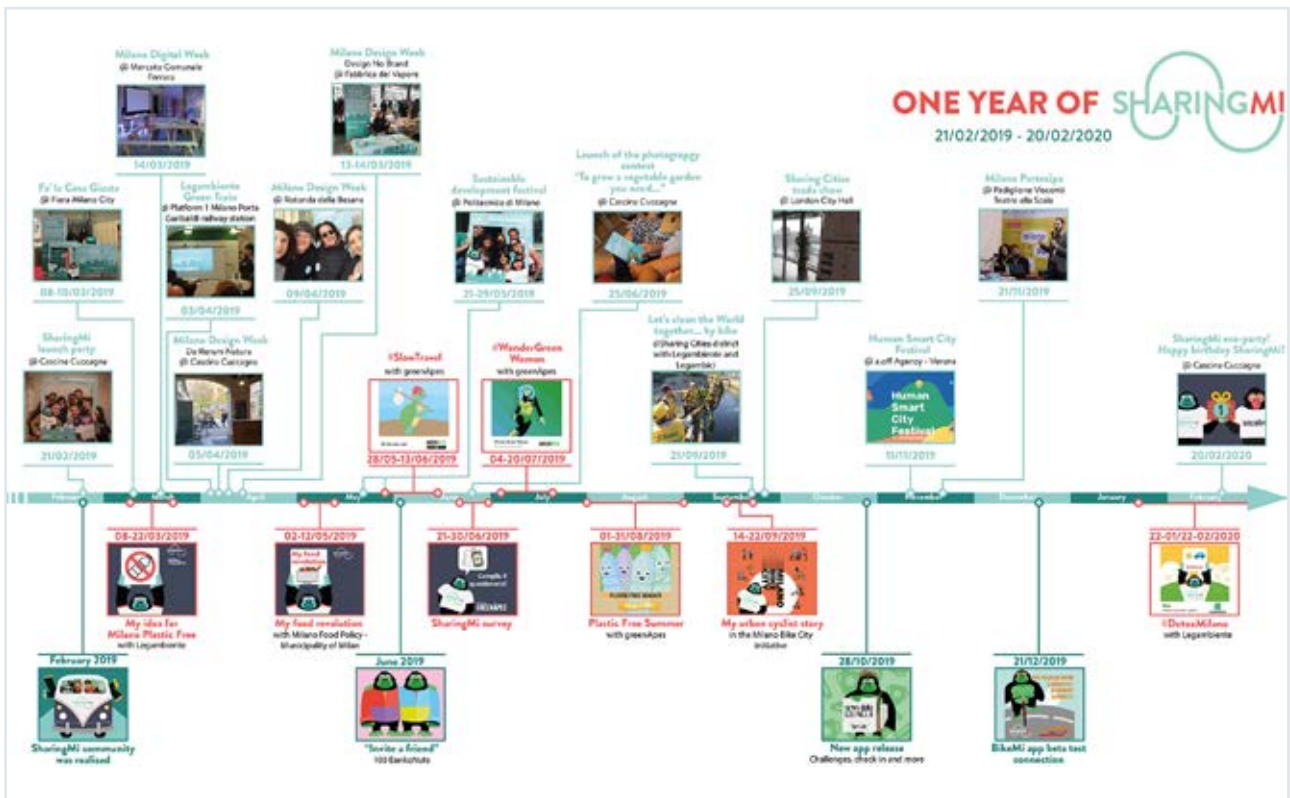



## Overview table: Education programmes in Smart Governance

### General Objective

- Recycle and reuse wastewater
- Promote multiple water use and water sustainability

### Specific Goals

- Raising awareness
- Improve water use behaviours
- Promote active involvement of citizens
- Enhance knowledge about water cycle for different categories of stakeholders (e.g. technicians, students, policy makers)

### Standard approach difficulties

Water education must go beyond the teaching of hydrological sciences and become multidisciplinary. Education must reach different categories of stakeholders and not only technicians.

### Smart Governance approaches

Smart devices and apps allow opportunities for involving stakeholders at different level in proactive learning.

Gamification approach involve citizens in learning and applying new knowledge, experimenting a behavioural change on water matters.

Gamification must be part of a wider communication/education programme

## Sources and further examples

[en.unesco.org/themes/water-security/hydrology/water-education](http://en.unesco.org/themes/water-security/hydrology/water-education)

[www.sharingmi.it/](http://www.sharingmi.it/)

<https://hydropolis.pl/en/>

<https://pijkranowke.pl/> (in polish)

<https://www.mpwik.wroc.pl/csr-2/mpwik-dzieciom/> (in polish)



# Conclusions

The present document shows an overview of possible smart approaches to water governance. The categories of intervention are described individually even if synergies and overlapping between them are frequent. A sound water governance design should consider all the categories of intervention and coordinate to consequent actions. Case studies collected in this documents show examples that can be inspiring to act for a smart approach to water governance.

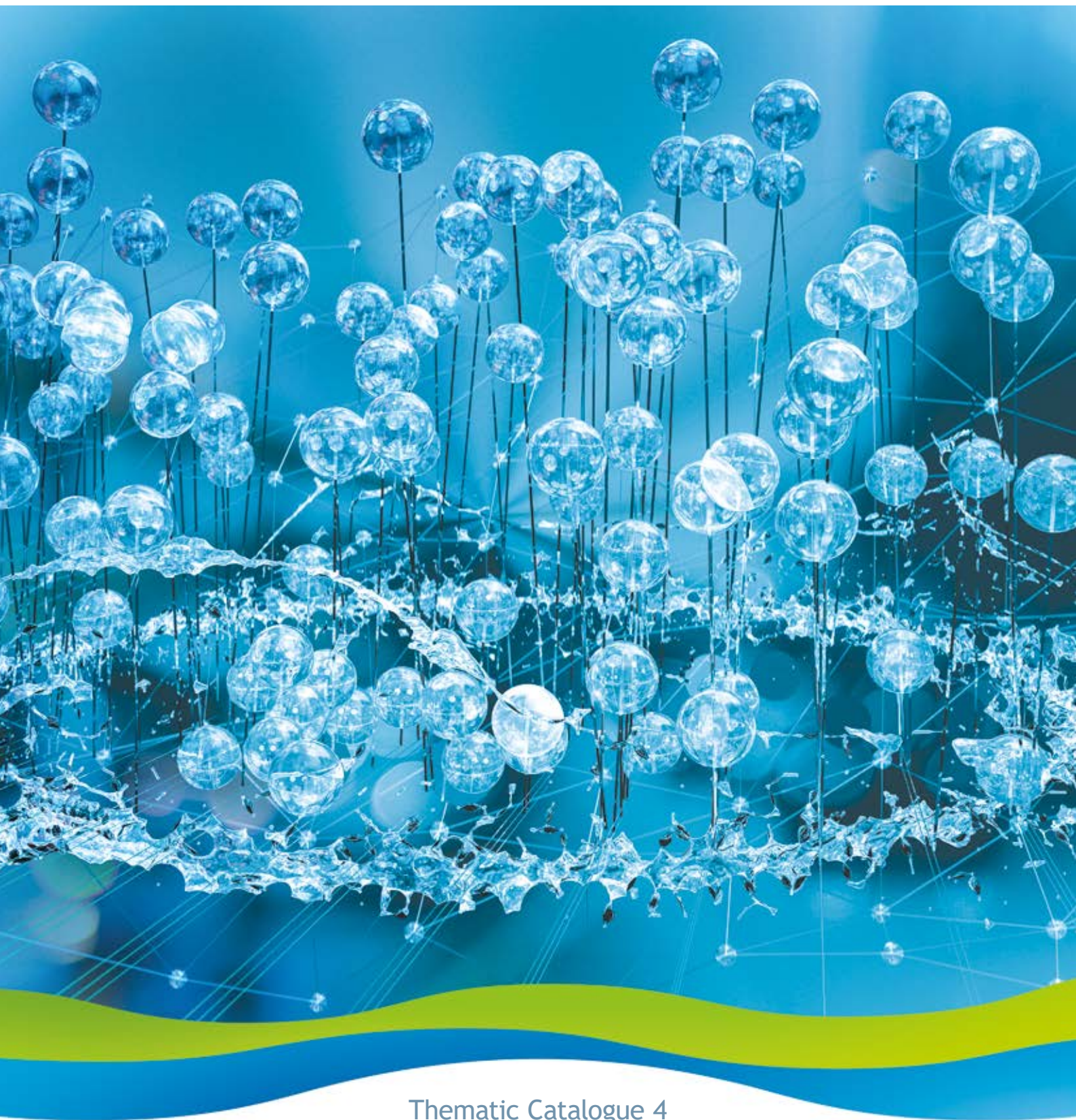

Thematic Catalogue 4

# Novel Digital Tools Promoting Water Efficiency Among Citizens/Consumers





# Content

<b>INTRODUCTION</b>	<b>250</b>
<b>1. EU-WIDE RESEARCH</b>	<b>251</b>
1.1. LIST OF WATER EFFICIENCY DIGITAL PROMOTING TOOLS	251
1.2. ONGOING EU PROJECTS DEVELOPED WITHIN H2020	264
1.3. EU CLUSTERS AND PLATFORMS FOR WATER MANAGEMENT	266
<b>2. SMART WATER METERING</b>	<b>267</b>
2.1. SMART WATER VALUE CHAIN	267
2.2. WHAT IS SMART WATER METERING?	268
2.3. SMART WATER METERING CONSTRUCTION AND APPLICATION REQUIREMENTS	269
2.3.1. Smart meter installation	269
2.3.2. Network	269
2.3.3. Software/services	270
2.4. APPLICATION AREAS	270
2.4.1. Examples	271
2.5. DIFFERENCES BETWEEN SYSTEMS AND PRODUCTS AVAILABLE ON THE MARKET	271
2.5.1. Examples	272
2.6. COSTS AND SAVING/BENEFITS	273
2.6.1. Costs	273
2.6.2. Benefits	274
2.7. CASE STUDIES	277
2.7.1. United Kingdom	277
2.7.2. France	278
2.7.3. Spain	280
2.7.4. Denmark	281
2.7.5. Croatia	282
2.8. IMPACTS OF SMART WATER METERING ON CONSUMER BEHAVIOUR CHANGE	285
2.8.1. Example	287
2.9. CHALLENGES AND LIMITATIONS	288
<b>LIST OF REFERENCES</b>	<b>289</b>



# INTRODUCTION

During the last several decades the world has seen incredible development within the Information and Communication Technologies (ICT) field. Not only has the number and quality of ICTs increased, but also their reach, variety as well as the number of users. Because of its availability, reach, multiplicity, accessibility, and speed, ICT is by many seen as being extremely beneficial for raising knowledge. Due to the aforementioned, digital tools and ICT in general while used for water efficiency are not serving only as useful technological and smart governance tools, but also as tools that can stimulate behaviour change among the general public along with raising knowledge on the given subject. In order to facilitate this even further, creation of a knowledge base introducing novel digital tools promoting water efficiency among citizens/ consumers have been planned within the “Project City Water Circles - Urban Cooperation Models for enhancing water efficiency and reuse in Central European functional urban areas with an integrated circular economy approach - CWC” project.

The document gives an overview of water efficiency digital tools and solutions that promote efficient water use and sustainable behaviour such as water saving, capturing rainwater, use of wastewater, a zero-waste lifestyle etc. The document includes a conducted EU-wide research that summarizes the collection of concepts, prototypes and close-to-market solutions based on the research of different resources, mainly those described on the Cordis website. The aforementioned list of the presented solutions include the tool name, the project from within it is developed (if applicable), a short description of the project/tool, their technology readiness level, the country where they are developed and where they can be used, as well as their corresponding website. In order to follow the future trends in water efficiency promoting tools, a list of EU clusters and platforms for water management are also presented, as well as the list of ongoing H2020 projects that develop/promote ICT solutions for water management. Finally, given the recognized potential of smart metering digital tools, both for water efficiency and the positive change of user behaviour, the last chapter of the Catalogue gives a comprehensive introduction of the aforementioned tools, which includes their use, constructional and application requirements, application areas, differences between systems on the market, cost and benefits as well as several examples and case studies.



# 1. EU-WIDE RESEARCH

## 1.1. List of water efficiency digital promoting tools

Based on the European research sources such as Cordis, EU Science Hub, the database of European Institute of Innovation and Technology, as well as extensive web research, a collection of water efficiency promoting digital tools and solutions whose aim is to influence user behaviour regarding water use is presented in the Table below. The table presents various software tools, mobile applications, e-platforms, games, alarm systems, smart data applications used and developed in the EU, as well as from within the tools was/is to be developed (if applicable), a short description of the project/tool, their technology readiness level (1 being the lowest - only basic principles are observed, and 9 being the highest - the system is proven to be operational), the country where they are developed and where they can be used, as well as their corresponding website sources.



**Tool:** Advizzo

**Project:** N/A

**Description:** A software solution that helps utility companies engage their customers to improve their operations/actions and to save energy and water.

**Technology readiness level:** 9

**Location:** United Kingdom

**Webpage:** <https://www.advizzo.com/>



**Tool:** BiWAS

**Project:** Biological Water Alarm System (BiWAS) for protection of urban drinking water infrastructure against CBRN threat

**Description:** A compact, early warning system for monitoring the quality of drinking water. The system is composed of a software network that allows its users to observe the water quality at multiple locations in near real time which facilitates sustainable water use.

**Technology readiness level:** 9

**Location:** Norway, Sweden

**Webpage:** <https://aquaalarm.net/>



**Tool:** B-WaterSmart

**Project:** Accelerating Water Smartness in Coastal Europe

**Description:** Smart data applications for more efficient, safe allocation & efficient use of water resources will be developed.

**Technology readiness level:** 5 - 7

**Location:** Belgium, Germany, Greece, Italy, Netherlands, Norway, Portugal, Spain

**Webpage:** <https://cordis.europa.eu/project/id/869171>



**Tool:** CASTWATER

**Project:** Coastal Areas Sustainable Tourism WATER management in the Mediterranean

**Description:** An online application that helps SMEs identify ways to assess and improve water management issues, and provides public authorities with statistics on current status of water management sustainability on tourism SMEs in the area in order to facilitate sustainable water use.

**Technology readiness level:** N/A

**Location:** Croatia, France, Cyprus, Greece, Italy, Malta, Spain

**Webpage:** <https://castwater.interreg-med.eu/>



**Tool:** The City Blueprint

**Project:** Blueprints for Smart Cities: Developing the methodology for a coordinated approach to the integration of the water and waste sectors within the EIP Smart Cities and Communities

**Description:** A software that permits target users to generate a concise, clear and effective analysis of the situation concerning Water and Waste and Energy, Transport and ICT in any given town or city.

**Technology readiness level:** N/A

**Location:** Belgium, Finland, France, Greece, Italy, Netherlands, Spain, Turkey, UK

**Webpage:** <https://cordis.europa.eu/project/id/642354>



## Thematic Catalogue 4



**Tool:** Closca Water

**Project:** N/A

**Description:** A mobile application with the largest number of water refilling stations in the world that. The application rewards its users for not using single use plastics, thus facilitating a change in their behaviour.

**Technology readiness level:** 9

**Location:** Worldwide

**Webpages:**

<https://apps.apple.com/us/app/closca-water-refill-everywhere/id1455330949>



**Tool:** DAIAD

**Project:** Open Water Management - from droplets of participation to streams of knowledge

**Description:** Employs Big Data and machine learning (ML) technologies to exploit data from smart water meters and help consumers change their behaviour in order to use water more sustainably.

**Technology readiness level:** 9

**Location:** Deployed in Germany, can be used worldwide

**Webpage:** <http://daiad.eu/>



**Tool:** Deepki

**Project:** N/A

**Description:** A software that automatically compiles and analyses its users' existing data to identify potential energy and water savings and a change in behaviour towards a more sustainable one.

**Technology readiness level:** 9

**Location:** Developed in the UK, can be used Worldwide

**Webpage:** <https://www.deepki.com/en/>



**Tool:** Dropcounter

**Project:** N/A

**Description:** A mobile application that connects users and their water utilities on the mobile devices they use every day. The application is used to understand and manage your personal water use; compare usage to similar neighbours; set and reach water use goals, and access valuable rebates and utility announcements.

**Technology readiness level:** 9

**Location:** Developed in the USA, can be used worldwide

**Webpages:**

<https://www.dropcountr.com/platform-home/>



**Tool:** DWC AR mobile application

**Project:** DIGITAL-WATER.city - Leading urban water management to its digital future

**Description:** An AR mobile application visualising geology and groundwater developed to highlight their relevance as a drinking water resource.

**Technology readiness level:** 5 - 7

**Location:** Deployed in Germany, can be used worldwide

**Webpage:** <https://www.digital-water.city/solution/augmented-reality-ar-mobile-application-for-groundwater-visualization/>



**Tool:** DWC mobile application

**Project:** DIGITAL-WATER.city - Leading urban water management to its digital future

**Description:** A mobile application that communicates bathing water contamination risks to residents in Paris in order to foster public engagement and raise awareness.

**Technology readiness level:** 9

**Location:** Developed in France (Paris)

**Webpage:** <https://www.digital-water.city/solution/machine-learning-based-early-warning-system-for-bathing-water-quality/>



**Tool:** DWC web-based game

**Project:** DIGITAL-WATER.city - Leading urban water management to its digital future

**Description:** A game that allows users to interact with data and support the understanding of the complexity of the nexus of water availability, carbon emission, energy consumption, food crop productivity.

**Technology readiness level:** 5 - 7

**Location:** Developed and tested in Italy (Milan)

**Webpage:** <https://www.digital-water.city/solution/serious-game-on-the-water-reuse-carbon-energy-food-and-climatic-nexus/>



**Tool:** Eco Life Hacks - Your sustainable coach

**Project:** N/A

**Description:** A mobile application that offers its users numerous simple ecological tips regarding consumption, energy, food, water and waste products.

**Technology readiness level:** 9

**Location:** Developed in Malta, can be used worldwide

**Webpage:** <https://play.google.com/store/apps/details?id=com.roland.ecolifehacks&hl=en&gl=US>



**Tool:** Eevie - Your Climate Guide

**Project:** N/A

**Description:** A smart guide carefully designed to help users improve their carbon impact by making small changes every day and planting forests to offset the rest.

**Technology readiness level:** 9

**Location:** Developed in Germany, can be used worldwide

**Webpages:**

<https://www.eevie.io/>

<https://play.google.com/store/apps/details?id=io.humboldt.eevie&hl=en&gl=US>



**Tool:** enCOMPASS

**Project:** Collaborative Recommendations and Adaptive Control for Personalised Energy Saving

**Description:** Innovative user-friendly digital tools to make energy consumption data available and understandable for different stakeholders in ways that empower them to achieve energy savings and manage their needs in energy efficient and cost-effective way.

**Technology readiness level:** 6 - 9

**Location:** Germany, Greece, Hungary, Italy, Lithuania, Romania, Switzerland

**Webpages:**

<https://cordis.europa.eu/project/id/723059>

<http://www.encompass-project.eu/>



Save me

**Tool:** Environment Challenge

**Project:** N/A

**Description:** A mobile app which facilitates users to change their behaviour in a more environmentally friendly way by offering various challenges, points and levels to achieve as well as giving daily news about the environment. One of the challenges includes reducing water waste.

**Technology readiness level:** 9

**Location:** Worldwide

**Webpage:** <https://play.google.com/store/apps/details?id=si.enki.tapwaterljubljana&hl=en&gl=US>



**Tool:** Fiware4Water IT platform

**Project:** B FIWARE for the Next Generation Internet Services for the WATER sector

**Description:** An IT platform that will contribute to the development of innovative digital solutions which will provide users with the needed information and offer suggestions for behavioural change and water saving at a household level.

**Technology readiness level:** 5 - 7

**Location:** France, Germany, Greece, Netherlands, Romania, Spain, United Kingdom

**Webpages:**

<https://cordis.europa.eu/project/id/821036>

<https://www.fiware4water.eu/>





## Thematic Catalogue 4

### FREEWA<sup>F</sup>

**Tool:** FREEWA

**Project:** N/A

**Description:** A web platform and a mobile app for mapping free drinking water locations worldwide.

**Technology readiness level:** 9

**Location:** Developed in Croatia, can be used worldwide

**Webpage:** <https://freewa.org/>



**Tool:** IMPREX game

**Project:** IMPROVING PREDICTIONS AND MANAGEMENT OF HYDROLOGICAL EXTREMES

**Description:** A game that aims to raise knowledge, awareness and facilitate citizens' change in behaviour. Through this game, the user tries to protect their city and its inhabitants from floods.

**Technology readiness level:** 9

**Location:** Belgium, Germany, Greece, France, Italy, Netherlands, Spain, Sweden, United Kingdom

**Webpages:**

<https://cordis.europa.eu/project/id/641811>

<https://www.imprex.arctik.tech/>



**Tool:** ISS-EWATUS

**Project:** INTEGRATED SUPPORT SYSTEM FOR EFFICIENT WATER USAGE AND RESOURCES MANAGEMENT

**Description:** An information system for gathering data about water usage is planned to increase the awareness of water consumption among consumers.

**Technology readiness level:** 9

**Location:** Greece, Netherlands, Poland, Spain, United Kingdom

**Webpage:** <https://cordis.europa.eu/project/id/619228>



## iWIDGET

**Tool:** iWIDGET

**Project:** Improved water efficiency through ICT technologies for integrated supply-demand side management

**Description:** An IT platform that contributes to the development of innovative digital solutions which provide users with the needed information and offers suggestions for behavioural change and water saving at a household level.

**Technology readiness level:** 9

**Location:** EU

**Webpages:**

<https://cordis.europa.eu/project/id/318272>

<http://www.i-widget.eu/>



**Tool:** NAIADES app

**Project:** A holistic water ecosystem for digitisation of urban water sector

**Description:** An application aimed at promoting user engagement in water conservation activities will be developed.

**Technology readiness level:** 5 - 7

**Location:** EU

**Webpages:**

<https://cordis.europa.eu/project/id/820985>

<https://naiades-project.eu/>



**Tool:** NextGen digital tools

**Project:** Towards a next generation of water systems and services for the circular economy

**Description:** Serious gaming and augmented reality will be developed and used as immersive tools to explore the circular economy and facilitate behaviour change in citizens and other stakeholders.

**Technology readiness level:** 5 - 7

**Location:** Belgium France, Germany, Greece, Hungary, Netherlands, Romania, Spain, Switzerland, United Kingdom

**Webpages:**

<https://cordis.europa.eu/project/id/776541>

<https://nextgenwater.eu/>



**Tool:** POWER

**Project:** Political and sOcial awareness on Water EnviRonmental challenges

**Description:** A user-driven Digital Social Platform (DSP) and ensuring the involvement of a wide society and knowledge community.

**Technology readiness level:** 5 - 7

**Location:** Germany, Israel, Italy, Netherlands, Portugal, Spain United Kingdom

**Webpages:**

<https://cordis.europa.eu/project/id/687809>

<https://www.power-h2020.eu/>



SCOREWATER

**Tool:** SCOREwater

**Project:** Smart City Observatories implement RE-silient Water Management

**Description:** A Real-time public engagement platform on urban surface and wastewater quality promoting water-friendly behaviour will be developed.

**Technology readiness level:** 5 - 7

**Location:** Belgium France, Germany, Greece, Hungary, Netherlands, Romania, Spain, Switzerland, United Kingdom

**Webpages:**

<https://cordis.europa.eu/project/id/820751>

<https://www.scorewater.eu/>



SIM4NEXUS

**Tool:** SIM4NEXUS game

**Project:** Sustainable Integrated Management FOR the NEXUS of water-land-food-energy-climate for a resource-efficient Europe

**Description:** : A game that aids learning about the Nexus by helping users understand and explore the interactions between water, energy, land and food resources management under a climate change context.

**Technology readiness level:** 9

**Location:** EU

**Webpages:**

<https://cordis.europa.eu/project/id/689150>

<https://www.sim4nexus.eu/page.php?wert=SeriousGame>



**Tool:** Smarth2O platform

**Project:** Smarth2O: an ICT Platform to leverage on Social Computing for the efficient management of Water Consumption

**Description:** The platform enables water managers to close the loop between actual water consumption levels and desired targets, using information on how the consumers adapt their behaviour to new situations: new regulations, new water prices, appeals to water savings.

**Technology readiness level:** 9

**Location:** Germany, Italy, Romania, Spain, Switzerland, United Kingdom

**Webpages:**

<https://cordis.europa.eu/project/id/619172>

<https://smarth2o.deib.polimi.it/>



**Tool:** Tap Water Ljubljana

**Project:** N/A

**Description:** A mobile app that promotes using free and clean water found in 17 locations throughout Ljubljana.

**Technology readiness level:** 9

**Location:** Slovenia (Ljubljana)

**Webpages:** <https://play.google.com/store/apps/details?id=si.enki.tapwaterljubljan&hl=en&gl=US>



**Tool:** UrbanWater

**Project:** Intelligent Urban Water Management System

**Description:** The platform enables a better end-to-end water management in urban areas. The platform benefits end-users by enabling them to use water more efficiently thus reducing overall consumption.

**Technology readiness level:** 9

**Location:** Croatia, Czechia, Denmark, France, Germany, Portugal, Spain, United Kingdom

**Webpages:**

<https://cordis.europa.eu/project/id/318602>



**Tool:** WatEner

**Project:** N/A

**Description:** A web platform that improves (daily) operation and management of water networks through real time performance monitoring and smart decision tools integrating data, models and expert knowledge. It facilitates more sustainable water use, reducing the carbon footprint and overall change in behaviour.

**Technology readiness level:** 9

**Location:** EU

**Webpage:** <http://watener.com/>



**Tool:** WATERNOMICS

**Project:** ICT for Water Resource Management

**Description:** Developing and introducing ICT as an enabling technology to manage water as a resource, increase end-user conservation awareness and affect behavioural changes, and to avoid waste through leak detection.

**Technology readiness level:** 9

**Location:** Greece, Italy, Netherlands, Poland

**Webpages:**

[h http://www.waternomics.com/](http://www.waternomics.com/)

<http://waternomics.eu/>



**Tool:** Water Footprint Network

**Project:** N/A

**Description:** A network which aims to use the water footprint concept for promoting the transition toward sustainable, fair and efficient use of water. The Water Footprint Assessment Tool is a free online web application that provides clear insight into how water is appropriated for human uses and the impacts resulting from those uses.

**Technology readiness level:** 9

**Location:** EU

**Webpage:** <https://waterfootprint.org/en/>



## Thematic Catalogue 4



**Tool:** Water Timer

**Project:** N/A

**Description:** A mobile app that tracks the user's shower time, calculates the amount and the price of the water used facilitating behaviour change.

**Technology readiness level:** 9

**Location:** Worldwide

**Webpage:** <https://play.google.com/store/apps/details?id=com.speedymarks.android.water&hl=en&gl=US>



**Tool:** WEAM4I app

**Project:** WEAM4I - Water and Energy Advanced Management for Irrigation

**Description:** A mobile app designed to provide farmers with information available, facilitating more sustainable water use.

**Technology readiness level:** 9

**Location:** France, Germany, Netherlands, Portugal, Spain

**Webpage:**

<https://cordis.europa.eu/project/id/619061>



**Tool:** WeSenseIT

**Project:** WeSenseIT: Citizen Observatory of Water

**Description:** Mobile crowdsourcing apps which encourage citizen communities to upload, share, discuss and rate data and information on their water environment with a focus on minimising the effects of pluvial flooding and poor water quality.

**Technology readiness level:** 9

**Location:** France, Italy, Netherlands, Poland, Spain, Switzerland, United Kingdom

**Webpages:**

<https://cordis.europa.eu/project/id/308429>

<https://www.wesenseit.com/>



**Tool:** WIDEST

**Project:** Water Innovation through Dissemination Exploitation of Smart Technologies

**Description:** An interconnected ICT system for water community to promote the dissemination and exploitation of EU funded activities and results in this area.

**Technology readiness level:** 9

**Location:** Belgium, France, Spain, United Kingdom

**Webpages:**

<https://cordis.europa.eu/project/id/642423>

<https://www.widest.eu/>



**Tool:** WISDOM

**Project:** WISDOM - Water analytics and Intelligent Sensing for Demand Optimised Management

**Description:** A system that aims to improve household, business and societal awareness, and induce changes in consumer behaviour.

**Technology readiness level:** 9

**Location:** France, Ireland, Italy, Spain, United Kingdom

**Webpages:** <https://cordis.europa.eu/project/id/619795>



**Tool:** WATER BATTLE GAME

**Project:** Vitens Innovation Playground

**Description:** A serious game that encourages customer engagement and influences behaviour change towards saving water.

**Technology readiness level:** 9

**Location:** Netherlands

**Webpage:** <https://waterbattle.nl/>



## 1.2. Ongoing EU projects developed within H2020

With the aim of following the development of digital solutions for promoting water efficiency, a list of relevant ongoing EU projects developed within the H2020 programme are listed in the table below.

Table 1. List of ongoing H2020 projects

Project	Description	Webpage
<b>B-WaterSmart</b> Accelerating Water Smartness in Coastal Europe	B-WaterSmart aims to accelerate the transformation to water-smart economies and societies in coastal Europe and beyond. Smart data applications for more efficient, safe allocation & efficient use of water resources will be developed	<a href="https://cordis.europa.eu/project/id/869171">https://cordis.europa.eu/project/id/869171</a>
<b>DIGITAL-WATER.city</b> Leading urban water management to its digital future	digital-water.city's (DWC) main goal is to boost the integrated management of waters systems in five major European urban and peri-urban areas, Berlin, Milan, Copenhagen, Paris and Sofia, by leveraging the potential of data and smart digital technologies.	<a href="https://cordis.europa.eu/project/id/820954">https://cordis.europa.eu/project/id/820954</a>
<b>Fiware4Water</b> FIWARE for the Next Generation Internet Services for the WATER sector	Fiware4Water intends to replicate success stories by linking the water sector to FIWARE, an open-source IT platform created in 2011 under the Future Internet Public Private Partnership funded by the European Commission.	<a href="https://cordis.europa.eu/project/id/821036">https://cordis.europa.eu/project/id/821036</a>
<b>NIAIDES</b> A holistic water ecosystem for digitisation of urban water sector	NIAIDES aims to promote innovative water management solutions to improve services for homes and public buildings, such as shopping malls and hospitals.	<a href="https://cordis.europa.eu/project/id/820985">https://cordis.europa.eu/project/id/820985</a>





## Thematic Catalogue 4

Project	Description	Webpage
<b>NextGen</b> Towards a next generation of water systems and services for the circular economy	The NextGen initiative will evaluate and champion innovative and transformational circular economy solutions and systems that challenge embedded thinking and practices around resource use in the water sector.	<a href="https://cordis.europa.eu/project/id/776541">https://cordis.europa.eu/project/id/776541</a>
<b>REWAISE</b> Resilient water innovation for smart economy	The Project will create a new “smart water ecosystem”, mobilising all relevant stakeholders to make society embrace the true value of water, reducing freshwater and energy use, resulting in a, sustainable hydrological cycle, to transition into a resilient circular economy. The Project especially addresses the challenges related to human behaviour and their attitude towards water.	<a href="https://cordis.europa.eu/project/id/869496">https://cordis.europa.eu/project/id/869496</a>
<b>SCOREwater</b> Smart City Observatories implement REsilient Water Management	SCOREwater enhances the resilience of cities against climate change and urbanisation by enabling a society and securing future ecosystem services.	<a href="https://cordis.europa.eu/project/id/820751">https://cordis.europa.eu/project/id/820751</a>
<b>SPRING</b> strategic planning for water resources and implementation of novel biotechnical treatment solutions and good practices	The project will provide an integrated water resource management tool for reliable water supply, i.e., it will provide cost-effective, real-time monitoring tools that treat polluted water bodies (stagnant and flowing). Successful implementation and demonstration of the developed systems involving all stakeholders will help to achieve wide public acceptance towards reuse and recycling of wastewater through the developed bioremediation technology	<a href="https://cordis.europa.eu/project/id/821423">https://cordis.europa.eu/project/id/821423</a>



### 1.3. EU clusters and platforms for water management

In order to follow the future trends in water efficiency promoting tools, a list of EU clusters and platforms for water management are presented in the table below.

Table 2. List of EU clusters and platforms for water management

Name	Description	Webpage
Aqua Europa	The European water industry association	<a href="https://aqua-europa.eu/">https://aqua-europa.eu/</a>
DigitalWater.City	A Web-platform for digital solution in water management	<a href="https://www.digital-water.city/">https://www.digital-water.city/</a>
ICT4WATER Cluster	A hub for EU-funded research and innovation projects that demonstrate the need for a digital transformation of the water sector	<a href="https://ict4water.eu/">https://ict4water.eu/</a>
SWAMP - Smart Water Management Platform	IoT based methods and approaches for smart water management in precision irrigation domain	<a href="http://swamp-project.org/">http://swamp-project.org/</a>
Water Europe	Multi-stakeholder platform for water-related innovation and RTD in Europe	<a href="https://watereurope.eu/who-are-we/">https://watereurope.eu/who-are-we/</a>

Other relevant water management include the following: Catalan Water partnership (CWP), CEL-ANTECH LATIVA, CREA Hydro&Energy z.s., CTA Energy and Environment, DREAM Cluster, Ecoliance Rheinland-Pfalz e.v, Finnish Water Forum, France Water team, Kuopio Water Cluster, Oulu university - AIF Water Ecosystem, Pole Aqua-Valley, Silesian Water Cluster, Stichting Water Alliance, Umwlet-cluster Bayern, WaterCampus Leewarden, and ZINNAE.



## 2. SMART WATER METERING

In the first chapter of this Catalogue, digital solutions that promote water efficiency and water conservation by influencing customer behaviour have been identified. These solutions are based on the Internet of Things (IoT), in other words, they refer to web-based applications, online tools, mobile apps and other software. During the aforementioned analysis smart water metering tools came into focus as solutions that can greatly influence consumer behaviour and promote efficient water use while being used in different economic sectors.

Due the growing population as well as the change in lifestyle and eating habits that have been associated with higher water consumption the demand for freshwater worldwide has increased significantly. This is more prominent in urban settings, which usually have higher population densities along with production industries that typically consume large amounts of water. Generally, the supply of fresh water to urban areas for domestic and industrial use has become more challenging. Thus, many utilities started the digital transition by adopting different smart metering technologies, i.e., automated meter reading (AMR) solutions in the beginning and moving to advanced metering infrastructure based on IoT. Implementing smart water metering (SWM) infrastructure allows utility companies to collect data faster and more efficiently and overall, it increases customer engagement by allowing them to visualize and predict their consumption. Accordingly, the implementation of smart meters and initiated behavioural change will impact higher water savings both for the utility companies and the consumers. It will also provide a better understanding of the digitalisation needed in the water industry as well as the benefits and limitations it brings.

Therefore, the second chapter of the Catalogue represents an overview of smart water metering technology regarding the use, constructional and application requirements, application areas, differences between systems on the market and cost and benefits. Also, several examples and case studies are presented as well as the state of the art in Croatia.

### 2.1. Smart water value chain

Before further elaborating on smart water services, it is important to present and interpret the smart water value chain and its stakeholders along with their desired needs from this new technology.

**Table 3. Smart water value chain**

Consumer	Utility	Regulation	External forces
Consumption	Distribution	Legal parameters	Climate change
Billing	Quality management	Technology drivers	Technology
Installation	Customer engagement	Price controls	Water sources

Communications



The main concerns for the consumer are consumption and quality of the water supply affected by location, leakages and excessive water consumption. That entails the billing system being accurate and installation being accessible. A connected smart water meter solves these issues with minimal interventions. On the other hand, for the water utility companies, which present the core part of the smart water value chain, smart water meters can be used to help them with various aspects of their operations - which includes simplifying the distribution, assuring water quality and increasing customer engagement. Water utility companies must operate in a regulated environment, which means that they have to meet key performance indicators set by the local policymakers. The water utility must report back on performance against these measures on a regular basis. The policymakers can also set new measures for solving specific issues within the local water market, such as water tariffs. External forces are something that water utility companies, regulators and consumers cannot control but, they have to adapt to. IoT sensors and smart water meters are key to transforming the water industry to meet such challenges. And last communications and big data technology drive the success of smart water metering and smart water networks (Mobile IoT). Water utilities need to be sure that their technology selections are fit for purpose and will provide a base for building new services into the future. All stakeholders in the value chain should be seeking a mutual relationship with each other that allows for flexibility in water services and use of technology to create efficiencies, build better services and maintain customer satisfaction.

## 2.2. What is smart water metering?

The smart water metering technology consists of an array of coordinated smart meters, from communications up to data management and software services, all presented in the figure below.

Figure 1. Smart water metering system



Source: [www.iskraemeco.com/app/uploads/2020/10/IE\\_Smart-Water-Management-Solution.pdf](http://www.iskraemeco.com/app/uploads/2020/10/IE_Smart-Water-Management-Solution.pdf)



A smart water meter not only measures water flow but also uses wireless communication to connect to local or wider area networks, allowing remote location monitoring and infrastructure maintenance through leak detection and thus, increasing time efficiency and adequacy. A smart water metering system not only provides frequent and accurate data 24/7 but also enables automatic billing and customer management, including detection and protection against tampering attempts. This means that customers can access their information online - which gives them greater control over their water use and bills. Smart meters remove the need for manual readings and estimated bills. They are battery-powered and thus, low-power devices play a crucial role in defining system configurations.

### 2.3. Smart water metering construction and application requirements

As mentioned above, the smart water metering system consists of several components that have to be integrated into the existing systems used by the water utility companies, such as customer information systems and operation management. In other words, synchronisation of consumers, devices inventory and consumption data with the existing system. Therefore, the constructional and application requirements are observed from the aspect of the smart meters, networks and software/services.

#### 2.3.1. Smart meter installation

Water meters are typically located in hard-to-reach places, like underground access holes, basements and generally at the property's boundaries. This makes the installation of a smart meter difficult as there is no access to power or communications networks within the home. With the implementation of the smart metering technology, the collection of data is possible without visiting the meter site. Nevertheless, there are certain construction requirements that need to be met when installing the smart meter for the first time. In other words, replacing the old water meter with a new one requires watersupply to be briefly turned off. In most cases, installation should take less than thirty minutes. When the new meter is installed, the person installing the meter has to test it to ensure that it is operational. For non-domestic users, installation may take up to several hours and the interruption of water services may be longer. Of course, it is important to emphasize that these devices are equipped with sensors, batteries, microcontroller, a suitable physical/wireless connector and other optional functionalities. Upon collecting the consumption data, the device stores readings in non-volatile memory and transmits data to a dispatching server over different communication networks.

#### 2.3.2. Network

A communication network is a simple network in a non-licensed band with low power demand and very good penetration and coverage. The transferred data is limited, which allows communication with many devices from one base station. Also, the communication has to be authenticated with each device and encrypted in an ultra-narrow frequency bandwidth with frequency hopping that ensures high security and noise resistance. The types of communication networks used include LoRA, M-Bus, Sigfox, NB-IoT or cellular networks GSM/GPRS, LTE, ZigBee, and even 5G can be used.



### 2.3.3. Software/services

The software architecture is multi-tenant and multi-vendor with a scalable and flexible infrastructure for advanced data analytics. Whereas the web-based user interface, usually an online platform, should be modern and responsive, which supports access and consistent look & feel option from PC and mobile devices. Some manufacturers of smart water meters or smart water digital solutions offer their own platforms for data monitoring such as Advizzo, Deepki or ADGT with its IOT24.eu platform, previously listed in this Catalogue.

## 2.4. Application areas

The main advantage of smart water meters is accurate billing and their efficiency which attracts numerous customers. Not only water utility companies and residential consumers, but also industries that use a large amount of water e.g., the agriculture industry, the textile industry, the service sector, and others.

According to the Smart water meter market analysis by Fortune Business Insight for the period 2015-2026, the European SWM (smart water meter) market was worth 0.48 billion dollars in 2018, while the global market size stood at 1.38 billion dollars. It is projected that by 2026, the global market size would reach 3.07 billion USD. Due to the fact that this technology attracts more and more customers each year, when observing the application area, the market seems to be divided into three sections: residential, commercial, and industrial.

Figure 2. Global SWM market share by application area in 2018

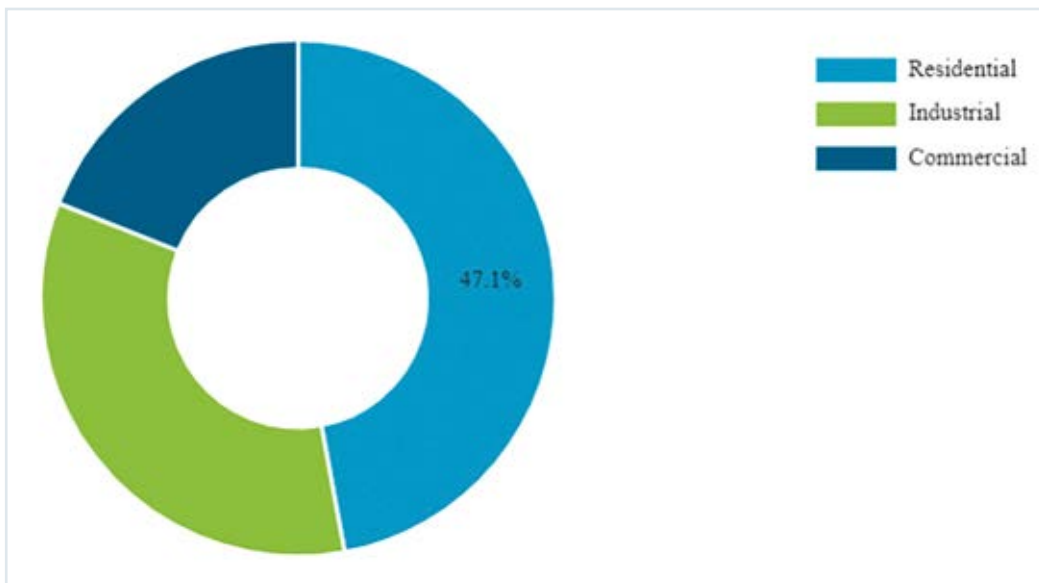

Source: [www.fortunebusinessinsights.com/industry-reports/smart-water-metering-market-100776](http://www.fortunebusinessinsights.com/industry-reports/smart-water-metering-market-100776)



It is expected and predicted that the residential sector is set to dominate the market, as it has during the past years. The reason behind this is the increase of consumers in the sector - the increasing population and urbanization in many countries. Following the residential sector, the industrial one is the second biggest application area. That is due to water being one of the essential raw materials and coolants in many industries worldwide.

Smart meters can be divided into residential, commercial and industrial, as well as main or zone meters. The main difference between these is in the technical architecture (sizing) of the metering device that varies depending on the required water flow rate coverage, efficiency, durability, location, occurring fluctuations etc., providing the optimum revenue at the same time.

### 2.4.1. Examples

As mentioned above, smart water metering technology can be implemented in various sectors. For example, due to the use of smart metering, Djordan hotel in Sofia, an estimated reduction of 15% in yearly water bills. Icade, a real estate company, recorded a 27% GHG reduction since 2015, whereas a Cromwell property group made 7% reduction in energy intensity only in 2020. When it comes to the industrial sector, savings in energy (electricity, water and GHG emissions) are recorded in large corporations. For example, due to use of watersaving measures and policies that include leakage detection, Fererro saved over 4 million square meters of water. Furthermore, company Johnson & Johnson reduced global water withdrawal by 22% from 2010 to 2019, whereas in the same period, Boortmalt under Axereal, made 30% savings in overall energy consumption.

## 2.5. Differences between systems and products available on the market

When it comes to smart metering systems in general the main difference is in the type of metering technology used. Respectively, the SWM system can use either the automated meter reading (AMR) or advanced metering infrastructure (AMI). The AMR is the communication technology water utility companies use to automatically collect water consumption and status data from water meters by walking or driving to the metering location. After collection, the meter data is transferred to a database where companies can monitor and analyse usage, troubleshoot issues and bill customers based on actual consumption, rather than predictions that were often required with bi-monthly or quarterly manual reads. More advanced AMR solutions have evolved but they still stop short of the AMI functionality. The AMI is an integrated system of water meters, communication networks and data management systems that enable two-way communication between meter endpoints and water utility companies. AMI doesn't require water utility personnel to collect the data, instead, the system automatically transmits the data directly to the company at predetermined intervals via a communication network. AMI increases customer engagement by allowing them to visualize and predict their consumption and detect water leaks and fraud while assuring the privacy and safety of their data at the same time.

On the otherhand, referring to Figure 1. Smart water metering system, it is shown that the smart water metering system is composed of different types of products/components, i.e., smart meters, communication networks, and software/services. The combination that will be applied by the user depends not only on the application area and requirements to be met but also on the desired services, prices and the system used by water.



### 2.5.1. Examples

In order to present the differences between products available on the market, three of the digital solutions analysed in the Catalogue are compared: Advizzo, Deepki and Daiad. Advizzo is a software solution developed in the United Kingdom that helps water utility companies engage their customers to improve their operations/actions and save water. Deepki is also a UK based company that has developed different software solutions which automatically compile and analyse the users' existing data in order to identify potential energy and water savings as well as to change the user behaviour towards a more sustainable one. Daiad was developed within the EU project "Open Water Management - from droplets of participation to streams of knowledge" by Germany, Greece, Spain, Switzerland and UK project partners and it employs Big Data and machine learning (ML) technologies to exploit data from smart water meters and help consumers change their behaviour in order to use water more sustainably. All solutions have several versions depending on the customer type. For this purpose, versions for the business/utility sector are compared in the table below.

Table 4. Comparison between smart water metering solutions

	ADVIZZO	DEEPMI	DAIAD
Edition name	Enterprise	Deepki - Reduce your energy costs	Daiad@Utility
Customer service platform	✓	✓	✓
Available worldwide	✓	✓	✓
Consumption history and monitoring	✓	✓	✓
Tariff optimization	✗	✓	✓
Budget adjustment	✓	✓	✓
Leakage detection	✗	✗	✓
Behavioural change tips	✓	✓	✓
Buildings comparison / household's comparison	✓	✓	✗
Support	✓	✓	✗
Free pricing	✗	✗	✓

Besides the business versions, residential versions as well as for other commercial users are also available, and the pricing differs depending on whether is a corporate made or a project developed for the general public.





## 2.6. Costs and saving/benefits

In the world of smart metering technology there are many more identified benefits than costs. To simplify the representation of both, costs are listed in the table, whereas the benefits are divided into business, customer and shared benefits.

### 2.6.1. Costs

The identified costs are followed by their description, cost bearer and cost estimation. The cost amount cannot be generally estimated since it depends on each individual case of smart water metering technology implementation. The table is constructed following the document Revealing unreported benefits of digital water metering: Literature review and expert opinions by Monks et al. whereas the examples of cost estimation are taken from the same document or from further internet research on the subject.

**Table 5. Costs of smart water metering technology**

Category	Description	Cost bearer	Cost estimation
Smart meter costs	Costs include procurement, installation and maintenance of the smart water meters	Utilities or customers	The cost of installation new meter can rise up to 100\$, Alicante, Spain
Networks, application and portal costs	Costs include establishment and maintenance of the network infrastructure, as well as data delivery and IoT services costs	Utilities or network/services vendors	Custom, for example the Advizzo's solutions for utilities are charged by meter per year
Project and contract management costs	The potential costs include staff training, re-training and (potentially) redeployment, project management, procurement management and facilitation, contract management, including QA activities on service delivery within the terms of the contract and the business process mapping, improvement and change management	Utilities	Custom
Customer engagement and marketing costs	Costs include the delivery of customers portal and marketing (including campaigns)	Utilities	Custom
Decreased revenue	Cost that appears due to the in "expensive" and "wasteful" water use, and quick leak detection	Utilities	Custom



## 2.6.2. Benefits

The benefits are divided into three sections, presented in the following tables. Each table contains benefit category and subcategory, description and example of savings made (where applicable). The tables are constructed following the document *Revealing unreported benefits of digital water metering: Literature review and expert opinions* by Monks et al. whereas the given examples are taken from the same document or from further internet research on the same subject.

### Business benefits

The benefits that water utility businesses can achieve by implementing smart water metering technology result in increased revenue, as presented below.

**Table 6. Business benefits of smart water metering**

Category	Subcategory	Description	Examples
Operational cost savings	Meter reading	Refers to reduced staff and labour costs, reduced number of estimated meter readings and meter reading errors, and reduction in billing and collection costs	171,000 \$ labour savings in Aiken, South Carolina, USA
	Financial management	Includes improved cash flow through monthly billing, reduction in working capital and improved revenue forecasting as well as reduction of the incidence of insurance claims and costs against water utilities	365 million \$ savings in working capital in Origin Energy, Australia
	Utility costs	Includes reduction in wholesale water cost, environmental benefits, reduction in water theft, network leaks and other non-revenue water causes as well as labour costs associated with leak detection	8% reduction of water consumption, Anglian Water, England
	Smart meters	Refers to technical aspect of the meters such as life cycle, accuracy over time, etc.	Depends on the meter used, batteries usually last from 10 to 15 years
	Tariffs	Refers to the possibility of designing more flexible tariff schemes	Adjustment of water prices
New knowledge	Customer segments	Savings made due to expansion of knowledge by acquiring additional information on customers such as business type for non-residential customers or tourist impacts on regions	Reduction of 10% in water consumption by tourists, Balearic Islands, Spain
	New algorithms	Savings made due to usage of more accurate and efficient models, improved sewer flow modelling and better demand forecasting	Improved meter sizing due to available hourly consumption data
Capital cost savings	Planning	Includes improved network/infrastructure planning and customer consumption modelling	20% reduction of network maintenance costs, Valencia, Spain
	Risk	Reduced risk premium models related to water management	Increased water utilities asset value



**Customer benefits**

Customers can be expected to benefit directly from water utility companies upgrading to digital water metering. These benefits are divided into customer service benefits and benefits caused by acquired new knowledge.

**Table 7. Customer benefits from smart water metering**

Category	Subcategory	Description	Examples
Customer service	Usage cost	Savings made due to real-time leak alerting, water consumption, monthly billing and increased customer awareness/education	3,7% reduction in household water usage for monthly billing, Wisconsin, USA
	Complex Property/Multiunit Usage Reconciliation	Refers to faster and easier reconciliation of bills for properties with multiple accounts and easier identification of plumbing irregularities in properties with complex plumbing	Easier and precise monitoring of water consumption in apartment blocks, complexes, etc.
	New services	Includes opportunity of individual billing day choice, data logging and analytics, leakage alerts, etc.	5-10% reduction in water consumption city wide due to rapid customer leakage identification
	New products	Refers to metering consumption per appliance and their water use profile including marketing of more effective appliances	Amphiro smart shower solution saved 17.1% in water and power, Gasthof Schonbuhl hotel, Switzerland
	Security	Includes improved property security by remote monitoring, monitoring of vacant properties (includes moving and switching water on/off) and consumption data security	2,25 million \$ savings per year due to remote monitoring of vacant properties, Kansas City, USA
New knowledge	Appliance use/End-use	Savings made due to acquired knowledge from smart meters and “smart” appliances and improved appliance efficiency (changes in demand and planning)	1,1% reduction in water use per household due to adoption of water-efficient appliances, Wisconsin, USA
	Benchmarking	Savings made due to combing meter data with other data (appliances, business type, etc.) and comparing similar demand profiles	n/a

Some of the listed benefits, such as security and benchmarking, are often difficult to quantify. Namely, security (excluding vacant properties) is an intangible benefit that gives customers the feeling of safety and increased satisfaction, whereas benchmarking allows customers to compare themselves with their peers and thus adapt their consumption. Whether the savings are the result of benchmarking is difficult to determine.



**Shared benefits**

Some categories of digital water metering could benefit both the water utility company and customers. For example, the benefits might deliver better customer service as well as a cost reduction for the business.

**Table 8. Shared benefits of smart water metering**

Category	Subcategory	Description	Examples
Customer interaction	Complaints	Includes reduction of customer billing complaints and improved outcomes from billing disputes and reduction of the company's internal costs, while for the customer it means higher satisfaction	80% reduction in customer complaints, EPA, Ecuador
	Customer assistance programs	Refers to programs that provide customers with assistance when they have concealed leaks (which means lower bills) or financial difficulty in paying their water bill, whereas for the company it means a reduction in plumbing assistance and high usage leaks reduction	Concealed leaks detection reduced from months to days means significant financial savings
	Credit management	Includes reduced supply-restriction-case costs and reduced debt-recovery/legal-action-case costs	High bills can be reduced by leak alerting and monthly billing and thus increase the customer's willingness to pay
	Customer interactions	Refers to the reduction in billing-related calls due to the provided customer service portals that increase customer satisfaction and overall customer experience	+60% improvement in the customer experience Valencia, Spain
	Goodwill	Includes improvement value of goodwill from information sharing, from new services and products, from customer recognition of operational efficiency and capital management, and from more flexible tariffs	The customers are grateful when they are alerted on leaks which is an example of the improvement of value of goodwill from information sharing that water utilities might enjoy
Regulation/ Compliance	Metering	Includes improved meter sizing for non-residential customers, improved meter failure analytics and detection of revenue losses	Costs in non-revenue water reduced up to 30%, Valencia, Spain
	Monitoring	Refers to monitoring consumption compliance with restrictions and regulations	Reduction of required water quality audits

To achieve all of the aforementioned benefits, the water utility companies would be required to make one or more changes to their systems, processes, and resources.



## 2.7. Case studies

### 2.7.1. United Kingdom

#### Southern Water<sup>1</sup>

Southern Water utility company provides water and wastewater services for Kent, Sussex, Hampshire and the Isle of Wight - thus, covering an area of 4,450 square kilometres and serving over 2.26 million customers. Since the Southeast of England is one of the most water-stressed parts of the UK, the Company, in their 2010 WRMP (Water Resources Management Plan), set out their plans to implement a universal metering programme - to install meters at the vast majority of customer properties, with the objective of saving water through reducing demand and improving leakage detection.

The project lasted 5 years and cost approximately 3.8 million euros. A key priority for Southern Water was to implement a “customer journey” and not just a programme to install 450,000 water meters. An information campaign (via digital and information media, marketing, etc.) was launched to advise customers how they could reduce water use and explain why metering was taking place. This customer contact took place around three months before meters were installed and operating - the campaign on its own, i.e., without meters in operation, led to a 12.5% reduction in customer water use. An important feature of the programme was visiting customer households. After the initial round of visits offering early advice, another round took place on the day of installation, providing customers with a booklet explaining that the meter is now being switched on and the various tariff choices available. This included a Changeover Tariff which ensures that, if a metered bill is higher than the older unmetered bill, the bill will be reduced for the first two years to allow customers to adjust their usage. Customers were also given the choice to switch straight to metered charges immediately following installation. Also, a range of financial support measures for customers with difficulty paying bills is offered. Support tariffs are available which include a home visit from a “Green Doctor”, who offers installation of free water efficiency devices such as tap aerators and low consumption shower heads. The programme has seen 156,000 such devices installed to customer homes, with a predicted average saving of 20l/d per household. Some households with a number of devices installed, plus the associated behaviour change to reduce usage, have seen reductions of up to 100l/d. Customers in significant hardship can have their bills reduced by up to 90% if they meet qualifying criteria.

The installation programme began in late 2010, with the initial phases focusing on the most water stressed areas of Southern Water’s resource zone including Southampton, Horsham and the Medway area, plus other areas where there was the greatest opportunity to reduce leakage. By the end of the project in 2015, the programme extended to cover almost 90% of all customer properties throughout Kent, Sussex and Hampshire.

The programme has delivered large water usage reduction of around 27 million litres of water per day across the Southeast of England, which was ultimately far more than the originally predicted 16 million litres. The automatic leakage detection facility has the capability to deliver a further saving of 7 million litres per day. These savings have had massive positive impacts on the environment of the region, with less water being taken from rivers and reservoirs, and less water requiring chemical treatment. Domestic consumption of water has been reduced by a total of 16.5% on average, which is far more than the predicted national average of 10% when meters are installed. Through reduced demand, customers have benefited from reduced bills - to 2016, 62% of metered households saved an average of 188 euro a year on water bills. Energy bills are also lower, as less heating of water is required for daily tasks such as central heating and taking a bath or shower - which can also make up around 30% of the average home’s carbon footprint.

<sup>1</sup> <https://www.ice.org.uk/knowledge-and-resources/case-studies/southern-water-universal-metering-project>



## Thematic Catalogue 4

### School in North London and City University London

Besides the residential, commercial (rentals, catering, etc) and industrial sector (retail, utilities, etc), smart meter technology is also being used in hospitals, universities and schools.

The “Water for Schools” programme (WfS) was a partnership established in 2011 to make schools in London more water sustainable. The programme ran for four years (2011-2014). In a School in North London activities included installation of AMR equipment, energy and water audit, educational visit and lectures on water and energy efficiency with the engagement of both students and teachers. The AMR system detected that the school had an ongoing problem with continuous consumption, with consumption occurring at night when the school was closed, which motivated a leakage survey to be conducted. The survey has shown that 3 ball-valves on storage tanks were faulty, causing the continuous consumption. Meter data showed that replacing these faulty items resulted in a water saving of 1,680 litres per day, or 613,200 litres per year. Based on current charges, that saved the school up to 1,473 euros per year on their water bill.

City University London which provides higher education, research and catering for around 17,000 students through six Schools, has taken actions to reduce water. Namely, the University uses a large quantity of water and as a part of their refurbishment programme they decided to reduce water use. Actions taken included continued monitoring of water use and cross-checking meter readings with water bills, installing flush controllers to all urinals that were previously uncontrolled, checking and regulating water pressure, carrying out regular checks on overflows, pipework, valves and water using appliances, and engaging staff and students in water efficiency through a behaviour change programme. That resulted in annual water savings of up to 2,500 m<sup>3</sup>, with the associated potential cost savings worth up to 5,800 euros.

## 2.7.2. France

### Eau du Grand Lyon, Lyon

Eau du Grand Lyon under the authority of the City of Lyon, operates and distributes the public water service to over 1.3 million people. In 2015, Eau du Grand Lyon implemented a smart water network using Birdz’s smart water sensors (meters and noise correlators) with LoRa devices. The new water management approach generated significant benefits i.e., identification, geolocation and faster repair of 1,200 water leaks in the distribution network, and 1 million cubic meters of water saved annually in production due to improved performance of the distribution network. The water utility company achieved an overall 8% increase in water network efficiency in four years, from 77% in 2014 to 85.2% in 2018.

### Accor hotels group<sup>2</sup>

Another area of SWM technology implementation is the tourism sector, where numerous hotels, hostels, campsites, etc. have adopted innovative watersaving systems and solutions.

Accor hotels group is one such enterprises. The Group was founded in France and today they count over 5,100 hotels in 110 countries worldwide. As Europe’s leading hotel group, in the heart of their agenda lays the environmental responsibility based on Planet 21, a program aimed at creating a positive hospitality experience. Planet 21 also includes Accor’s targets for their buildings regarding energy, water, waste, food and carbon footprint.

<sup>2</sup> <https://group.accor.com/en/commitment/planet-21/building>



## Thematic Catalogue 4

Since water is identified as an environmental and economic issue, the Accor hotels mapped the level of exposure to waterstress as mostly “average to high”, “high” and “very high”, especially since one-fourth of their hotels is located in drylands (Figure 3). Most of the hotels in water-stressed regions are located in Europe (especially in Spain and Italy) and Asia. The Group focuses its efforts on China in particular. Average water consumption per overnight stay in China is close to 800 litres, compared with 200 litres in other waterstressed regions. Therefore, the Group has decided to implement watersaving measures for all hotels and thus, also reduce costs.

Figure 3. Current water stress in Accor hotels

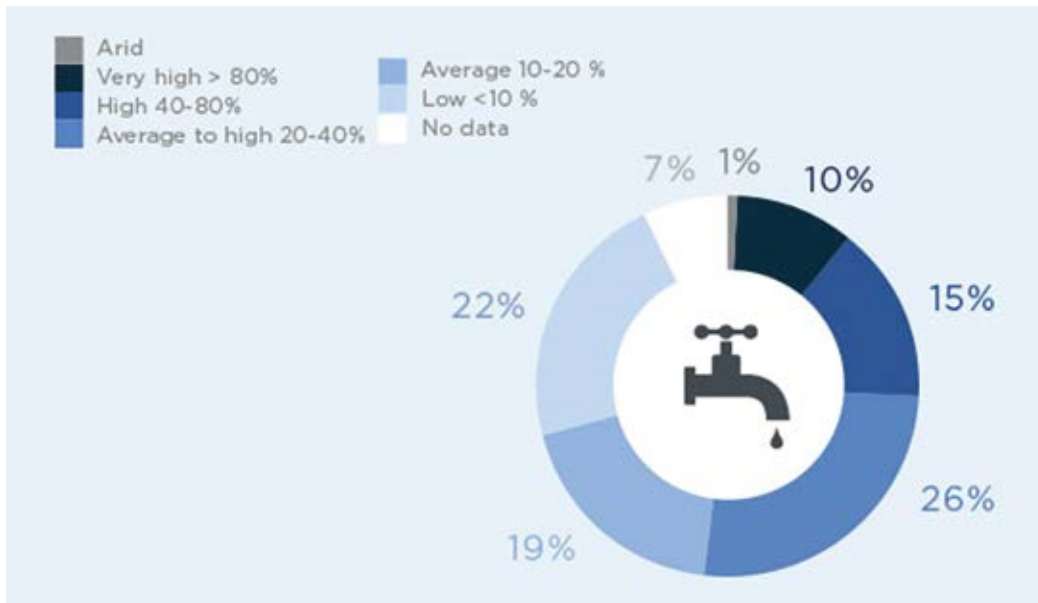

Source: <https://group.accor.com/en/commitment/planet-21/building>

To reduce water consumption and costs Accor introduced several initiatives:

- introduction of an online tool (OPEN) in 2005 and Deepki’s digital solution (after 2016) for energy and water monitoring,
- installation of building management systems to monitor energy consumption,
- an increasing number of energy-saving measures, including low-consumption lighting, heat recovery from ventilation systems, hot and cold fluid pipe insulation, water-saving devices, dual-flush toilets, smart meters,
- raising employee and guest awareness of the need for judicious consumption of water and energy.

The figure below presents water consumed by owned, leased and managed hotels in the Group between 2011 and 2015. The implemented measures resulted in overall 8.4% reduction of water consumption in the same period (average for all hotels worldwide).



Figure 4. Water consumed in Accor hotels

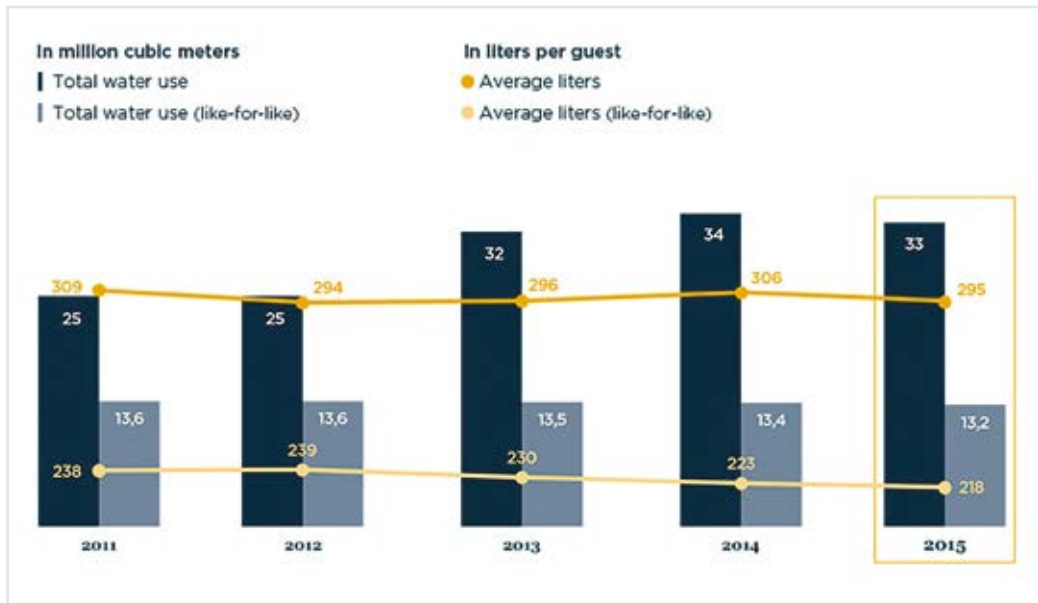

Source: <https://group.accor.com/en/commitment/planet-21/building>

Also, by the end of 2015, the 97% of the hotels in the Group have installed flow regulators on showers and taps, 78% applied water-efficient gardening practices, 70% implemented a water-efficient laundry system and 67% used dual-flush toilets. Moreover, the hotels located in “high” waterstressed areas or drylands cut their water consumption by 11%.

In 2016, the Accor hotels introduced The Water & Carbon plan that referred to more precise monitoring tools (smart metering systems), facilities optimization, LED lighting, water flow regulators, raising employee’s awareness and carbon monitoring. The plan resulted in -5% of energy consumption per room and -5% of water consumption per night in 2018 in owned, leased and managed hotels worldwide.

### 2.7.3. Spain

#### Gandia<sup>3</sup>

Gandia is one of the largest coastal towns in Spain. With a population of over 200,000 during summer, it is a very popular tourist destination that consumes large amounts of water, especially during the peak season. Therefore, the city’s authorities decided to optimize resources, foster water efficiency and offer excellent service to the population.

The previous water consumption monitoring relied on walk-by and drive-by methods, so no real-time data was available. As a result, water demand could not be accurately predicted and work orders and leak detection were not managed efficiently. In this context, Gandia sought to control water consumption in real-time through smart meters, as well as to offer value-added services to citizens by transmitting and analysing the collected data. The project also focused on reducing wastewater use and maximizing efficiency in the use of resources for water catchment, treatment and distribution.

<sup>3</sup> <https://www.idrica.com/case-studies/>





## Thematic Catalogue 4

Idrica (company that leads the digital transformation of the water industry), Vodafone and the municipality joined forces in an initiative that included the deployment of 40,000 smart meters. Vodafone's NB-IoT network collects and transmits consumption information, while the GoAigua (Idrica's solution) technology converts data into useful services for end-users. The project has fostered sustainable resource management, with significant savings in water (including wastewater) throughout the cycle, as well as the reduction of energy consumption in the water extraction and treatment processes. For example, the smart water system enables detection of approximately 60 extreme and 150 regular leaks per month, saves 112 tonnes of CO<sub>2</sub> and 0.5 cubic hectometres of water a year.

### GoAigua in Hamad International Airport

The Airport, which is located in the city of Doha, Qatar, has been operating since 2014 and has a capacity of 30 million passengers a year. The airport was struggling with a large volume of undetected losses and leaks in its extensive distribution network, running into thousands of m<sup>3</sup>.

In this context, a regulated inventory had to be implemented to manage the facility's assets and to establish a monitoring system for the distribution network. Centralized management of distribution and supplies also had to be introduced. The project combined engineering services with the implementation of GoAigua's technological solution to combat leaks. Thus, enabled Hamad Airport to reduce non-registered water through network mapping, the installation of sensors and centralized management of its assets, facilities and distribution networks. More precisely, the Airport reduced maintenance costs by 20% and installation costs of digital solutions by 80%. Also, the energy consumption the airport dropped by 15% and leaks in the network were reduced by 60%.

## 2.7.4. Denmark

### ALBOA Housing Association, Aarhus<sup>4</sup>

The public housing association ALBOA is responsible for the administration and leasing of approx. 7,000 homes distributed across 80 housing divisions (i.e., public rentals). The majority of the homes are in multi-storey buildings that were built between the 1950s to 1970s. However, the portfolio also includes more modern buildings, such as low-rise terrace houses. A pair of new low-energy housing divisions were added recently, and several of these homes already meet the energy requirements for 2020. The major difference between the divisions is not just the housing stock, it's also the way water and energy metering are carried out. Today, around a third of ALBOA's 80 housing divisions have individual water meters installed, while another third has no individual meters installed at all. The remaining third of residents are billed directly by the utility company.

A housing division with 156 leases reduced its water consumption by 50% after individual meters were installed. In round figures, they save 6,000 cubic metres which means the tenants benefit from annual savings of around 40,000 euros. ALBOA expects to upgrade more of its buildings to individual metering in years to come.

### Tinderhøj School, Rødovre

Tinderhøj School has installed a Water Management System in 2019 as part of the new digital initiative. In fact, the initiative is the first of its kind in Denmark and in addition to operational savings, the system includes a learning screen at the school's reception that affirms and enhances the its

<sup>4</sup> <https://www.kamstrup.com/en-en/customer-references/submetering/case-alboa-housing-association>



Green credentials. The system cost around 54,000 euros and included an installation of 180 smart water taps and monitoring system. The data monitoring enables the school to receive leak alarms, keep track of water consumption and make hygiene rinses that protect against stagnant water. The measure is part of Rødovre Municipality's energy renovation initiative, which aims to reduce the total CO<sub>2</sub> consumption by 2% annually.

### 2.7.5. Croatia

The activity of water supply in the Republic of Croatia, in 2016, was performed by 449 legal entities (135 public and 314 local suppliers), of which 62 supply more than 5,000 inhabitants and deliver more than 1,000 m<sup>3</sup> of water per day. There are four counties in Croatia that deliver more than 20 million m<sup>3</sup> of water - Primorje-Gorski Kotar, Split-Dalmatia, Istria County and the City of Zagreb. It is estimated that 87% of the population is connected to a public water supply, and about 1.6% to a local water supply. The population's connection to the water supply network has increased by 32% in last the 30 years. In continental Croatia, there is still a lower supply from public systems and a higher one to local supply systems than in Istria or Dalmatia. In recent years, however, there has been a decline in residents connected to local systems.

The state of the art in water metering technology in Croatia refers to standard personnel reading or AMR technology with walk-by or drive-by readings. Some of the water utilities enable online bill payment as well. However, a Vodovod i odvodnja Zagreb (VIO Zagreb) water utility company upgraded parts of its network into AMI technology. The pilot project, conducted in 2011, is presented below.

#### **VIO Zagreb's pilot project VIO AWMR**

VIO provides water and drainage services for the City of Zagreb and parts of Zagreb County. The water supply network covers over 800 square kilometres with approximately 900,000 inhabitants. The service area of the city alone covers around 360,000 consumers with 170,000 different types of water meters out of which 25% are remotely read. For that amount of metering devices, 520,000 readings are conducted in 2011 which means each device is read approximately 3 times per year.

The existing remote reading system in VIO was based on M-Bus bus technology. This system is specially developed for gas, electricity and water consumption reading systems, and is designed to collect signals via two lines. The M-Bus has a hierarchical system (Figure 5) with communication controlled by a central unit (master). Several auxiliary units (slaves) are connected to the central unit in parallel via a two-core communication cable, and such a unit can send the collected data to the central billing system. These can be various modems, GSM/GPRS devices, ADSL connections, etc. There are also possibilities to collect data on water consumption from the data logger by visiting the reader with hand-held antenna devices (walk-by) or remotely via vehicle (drive-by).



Figure 5. M-Bus system

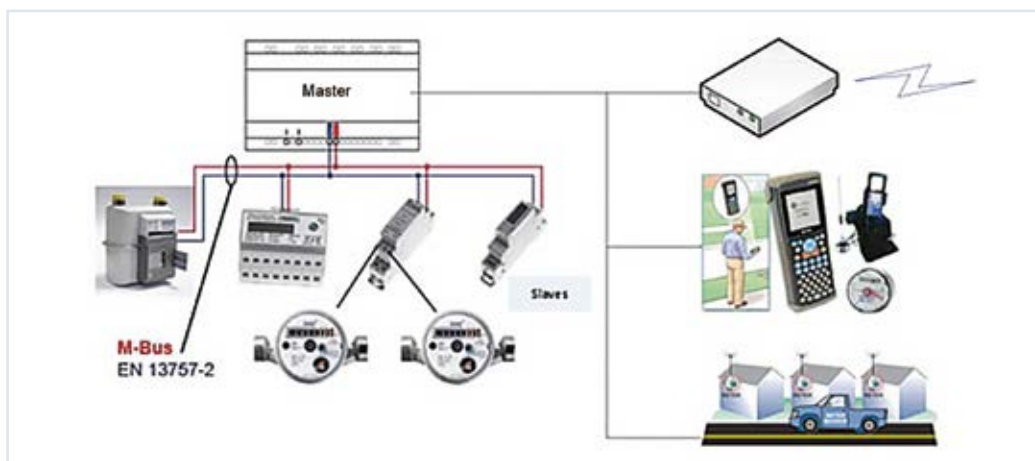

Source: <http://www.infotrend.hr/clanak/2012/11/sto-to-mudri-rade-s--pametnim-mrezama-,75,960.html>

Of the total number of pulse water meters located in this system, which are installed in the City of Zagreb, only 13% of them fully meet the requirements of reliable reading. Therefore, classic manual readings (87%) are performed at these locations. The main reasons for this situation mainly include the poor quality of impulse water meters and poor maintenance of the entire M-Bus system (which is the responsibility of investors/users). This shows that the system does not satisfy the needs of remote metering and it does not provide customers with an insight into their consumption, leakage alerts or the option of online billing. Thus, the Company decided to implement an AMI reading technology (Figure 6) called AWMR VIO.

Figure 6. AMI system

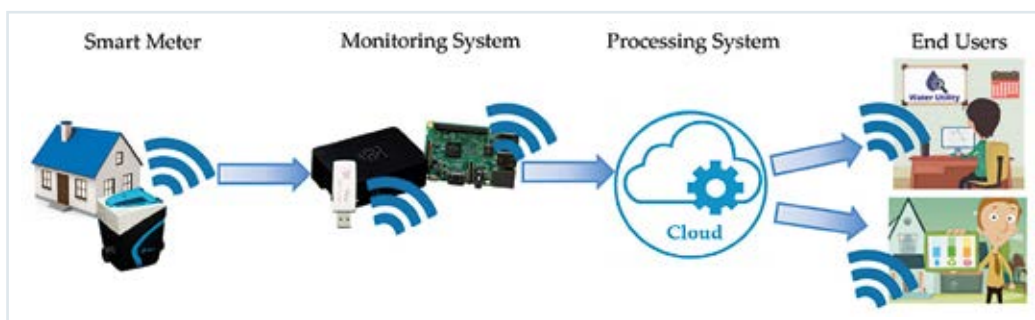

Source: <http://www.infotrend.hr/clanak/2012/11/sto-to-mudri-rade-s--pametnim-mrezama-,75,960.html>

The AWMR VIO is an integrated system that includes:

- system equipped with ZigBee/802.15.4 network communication protocol with two-way communication;
- data transfer from metering device to VIO UPN (contracting, sales and billing) via its own fixed network;
- advanced alerting system: leakages, cracks, unauthorized construction of water meters;
- enabled communication with information system for energy management;
- advanced billing system (e-UPN - Moj VIO);
- real consumption online monitoring;
- enabled connection with other household smart devices;
- possibility to connect to other smart grids (electricity, gas, heat).



## Thematic Catalogue 4

The central part of the AMI system is Končar MARS (Figure 7) software that collects and stores measurement data and enables their later processing and display. The user interface of the web-app holds a geographical chart with the location of the devices, insight into the consumption of each meter and alarm status, and online billing.

Figure 7. Končar MARS web-application interface (2011 concept)



Source: <http://www.infotrend.hr/clanak/2012/11/sto-to-mudri-rade-s--pametnim-mrezama-,75,960.html>

Figure 8. Moj VIO - billing system registration interface (2021)

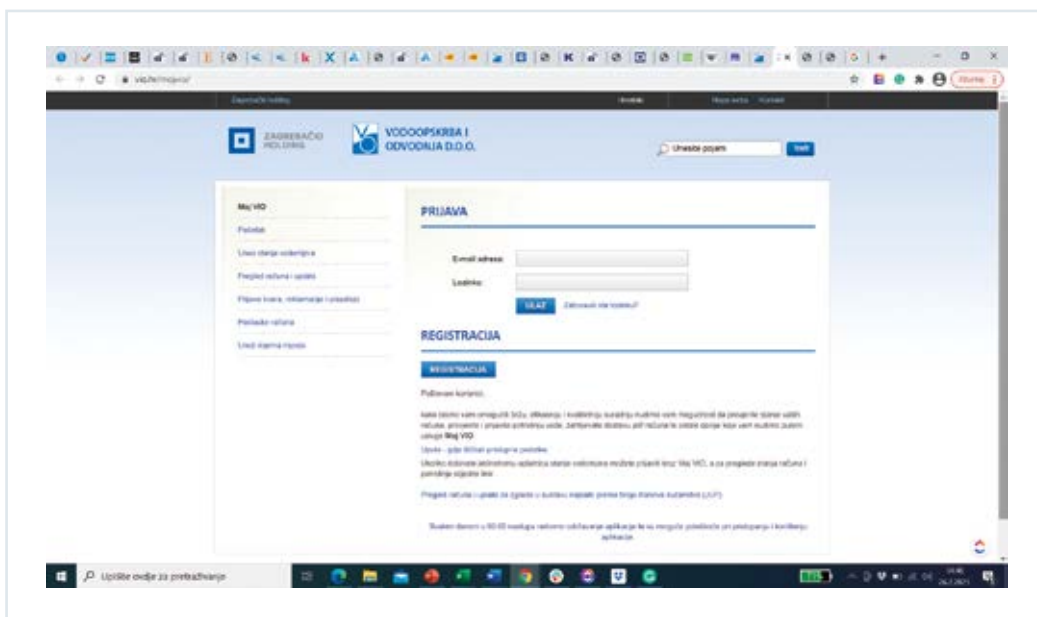

Source: <https://www.vio.hr/mojvio/>



The pilot showed that the cost-effectiveness of the solution increased with the possibility of deployment in the Cloud, thus facilitating maintenance and reducing costs. The integration with the online billing enabled greater satisfaction of the end-user and additional savings for the VIO, but also for any other utility or a similar company that applies it.

For VIO Zagreb, the novel AMR technology that transmits data over stationary radio receivers was implemented on the Island of Kaprije (Šibenik-Knin County) by Vodovod i odvodnja Šibenik (VIO Šibenik). Thus, removing visits to the metering sites, enabled the monitoring of water consumption at any time and efficient and quick detection of leaks.

### Elementary school 'Nad lipom'

Elementary school 'Nad lipom', located in Zagreb, works with children with disabilities. A part of the school is Eco group that conducts many projects regarding environment and energy preservation. One of the projects was water conservation project called Journey of the Drop of the Water 2008/2009. Project started by successfully entering a competition of the Armal foundation of Mariborske livarne Maribor Ltd. themed "Armal for healthy, drinkable water". The project included educating people/students about the importance of healthy, drinkable water for all living creatures, and importance of preserving sources of such water. The same resulted in 10% water conservation and winning award of 10 'smart' Armal faucets for improving school's plumbing infrastructure.

Taking the abovementioned into consideration, although the level of smart metering technology in Croatia is still in conception and based mostly on AMR, there are many EU and national projects that support digital transition of the water sector and promote water conservation behaviour among citizens. Therefore, the boost of technology implementation and change of behaviour towards water sustainable one is expected in the future.

## 2.8. Impacts of smart water metering on consumer behaviour change

The previous chapter demonstrated the costs and benefits of smart water metering technology. As shown, not only does this technology bring financial savings to customers, it also increases their satisfaction, security and actions of goodwill. Thus, it is safe to assume that this technology, especially the digital tools that allow individual consumption monitoring, has an impact on the customer's behaviour changing it towards a more efficient and sustainable one. This is only an extension of overall socio-economic behavioural change fostered in the last decade. Due to arousing climate change, potable water scarcity issues and severe droughts are present worldwide.

Therefore, water utility companies and governments throughout the world are trying to stimulate water conservation behaviour by raising awareness on water-related issues and implementing smart water metering systems and promoting digital tools. For example, public media campaigns in Barcelona during several years achieved near-complete awareness (92%) of the impacts of severe drought and the associated need for water conservation. Moreover, nearly two-thirds of the population reported having adopted measures to reduce their water consumption, although the majority of actions were behavioural, such as taking shorter showers (74%), turning off the tap while brushing teeth (67%) and only using the washing machine when full (49%). The potential impact on water savings can have flexible water tariffs and water-efficient appliances. For example, a study in Australia showed an 80% reduction in water demand due to the use of rainwater tanks. The adoption of smart water metering technology decreased water demand by providing consumers with insight into their consumption profiles, leakage alerts and tips for better water management. Using smart



## Thematic Catalogue 4

water meters enables better pricing, precise billing and personalized messaging that can improve the water-saving potential of implementation and decrease the effect of offsetting behaviour. The abovementioned customer/shared benefits presented some examples of water consumption reduction as a result of SWM implementation.

The digital solutions listed in this Catalogue aim at citizens/customers behavioural change by promoting water efficiency and conservation through different platforms (Fiware4Water, Freewa, iWIDGET, etc.), online tools like Castwater, various mobile apps (Eevie, Eco life hacks, Environment challenge, etc.) and online games such as Imprex and DWC Game Nexus. For example, the users of Dropcountr mobile app save up to 9% in monthly water, whereas use of Advizzo's solutions, that offers personalised behavioural change tips, resulted in 6-9% energy savings per household yearly.

Figure 9. Water conservation drivers and levels of intervention

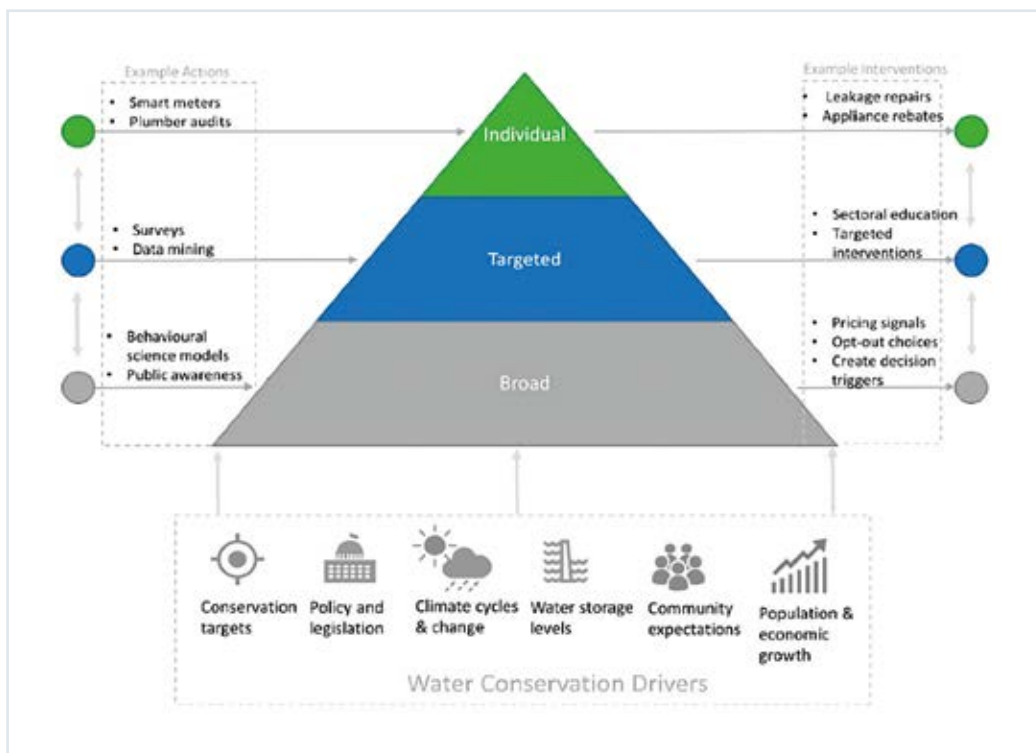

Source: [https://www.researchgate.net/publication/328495243\\_Promoting\\_Water\\_Conservation\\_Where\\_to\\_from\\_here](https://www.researchgate.net/publication/328495243_Promoting_Water_Conservation_Where_to_from_here)

Figure 9 depicts the types of actions that might be applied for interventions on a spectrum from broad-based approaches that seek to shape water demand for all customers, to more targeted approaches at specific sectors or cohorts that have been identified as receptive to water conservation, and finally, actions at the level of an individual customer.



### 2.8.1. Example

Vitens is the biggest drinking water company in the Netherlands and annually delivers 350 million m<sup>3</sup> of water through 100 water treatment plants and 49,000 km of water mains. Being a leader within the water industry, Vitens began thinking outside the box on how to best influence human behaviour and whether it could reduce peak usage within their network, which in turn would safeguard the lifespan of their infrastructure. Vitens wanted to see whether they could influence human behaviour through the use of innovative technology and serious gaming. Another key factor for the utility was to understand the power of the younger generations; once they learned a behaviour would they be able to teach it to older generations? This aspect of the trial would also help Vitens further develop in-depth customer engagement which is an invaluable asset to have for the continuous evolution of a brand. The more technical aspect of the company's challenge was the need to identify and flatten the peaks in the network during key times. Achieving this would also allow them to improve network sizing which in turn would allow them to increase the overall efficiency. If Vitens used smart water sensors, the data they transferred within the network would allow them to understand the technical requirements surrounding water flow/demand needed in order to help influence customer mindset and behaviour.

As a possible solution, Vitens decided to carry out a trial over a 3-month period with 180 participants. Using innovative technology throughout their water networks, Vitens' smart grid consisted of 300 sensors, across 9,000 km of infrastructure with a dedicated IT infrastructure and state of the art control room. The trial was carried out in the City of Leeuwarden in northern Holland, that Vitens coined 'Vitens Innovations Playground'. The data was collected by smart meters and transferred to the gaming server by the FlexNet™ radio system. The key difference with any other trial that has previously been undertaken is that the utility was using the power of gaming to influence human behaviour, but also gave the utility further information on peak usage times within the network and how they could change the consumer-side demand.

The results of the 3-month trial were promising. Not only did 83% of participants indicate that they had received a better insight into their own water consumption, but the awareness on the importance of reducing peak consumption increased from 40% to 90%. Another important aim the utility had, was to improve network sizing and peak usage, to safeguard the infrastructure and the health of the water in the network. During the trial, there was a 14-21% reduction in the energy used to supply water in the morning and evenings, and a 7% reduction in water usage in those peak times as well. For Vitens, a 7% reduction in water consumption relates to 23 million cubic meters per year.

Figure 10. Results of utilising The Water Battle game

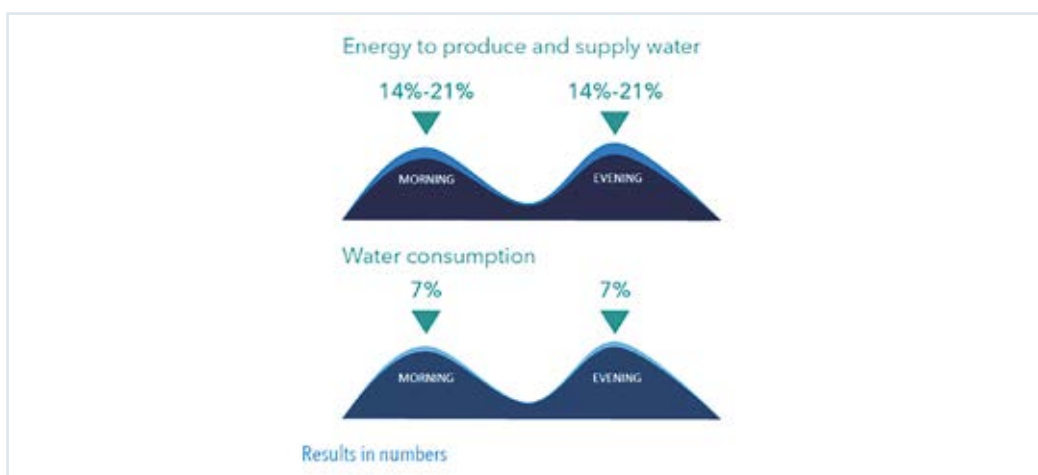

Source: <https://sensus.com/emea/resources/case-studies/influencing-human-behavior-reducing-peak-consumption/>



## 2.9. Challenges and limitations

Every technology has its advantages and challenges regarding implementation whether infrastructural, environmental, societal or other. Hence, the smart water metering is no exception. The challenges of this technology are divided into three categories i.e., technical, knowledge-based and practical.

### Technical challenges

These challenges encompass the necessary equipment installation and water network system adaptation. Hence, the limitations refer to the technology that easily becomes out-dated and damaged, the compatibility of meter-communication systems, difficulties with customer portal-privacy concerns and variability in walk/drive-by signal as well as wireless signals. The lack of a common standard for the technology and disparity in communication, information and frequency protocols between manufacturers also presents one of the key issues. Adoption of smart water technology does not just face technical and research-oriented constraints, but also financial constraints, such as lack of funding (due to high investment). Even though funds are available, many times, there is no proper technical support (depending upon geographical locations), which is required to successfully maintain such technology. The decision regarding opting for such technology for the betterment of the city depends on the local governance.

### Knowledge-based challenges

Knowledge-based limitations are part of social constraints usually connected with privacy issues, general rejection of new technologies and lack of know-how of suitable technologies: “what, where and why”. For example, the users might be afraid of the usage of personal data stored on the cloud and that their data will be misused by some third person. Thus, laws need to be created by governments, which will restrict the industry from misusing personal data by firms or through cyber-attack. Also, since SWM is an emerging technology, the water industry’s knowledge and experience is still limited in rolling out projects and there are few existing business cases showing quantifiable outcomes. However, there are issues when developing business cases such as the reluctance from internal hierarchy, existing industry standards insufficient for business needs, difficulties in obtaining suitable technology and others.

### Practical challenges

Such limitations include the time needed to install and commission meters, the lack of existing business system and workflows, data management and data analytics that refers to know-how to maximise benefits of the data, and engagement of non-residential customer to act on leak alerts.





# List of references

1. <https://www.fortunebusinessinsights.com/industry-reports/smart-water-metering-market-100776>
2. <https://www.advizzo.com/>
3. <https://www.deepki.com/en/>
4. [http://daiad.eu/index5ae0.html?page\\_id=2002](http://daiad.eu/index5ae0.html?page_id=2002)
5. [https://scholar.google.com/scholar\\_lookup?title=City+cuts+costs,+improves+accuracy+with+radio+frequency+meter+reading&author=Hastreiter,+J.&publication\\_year=1997&journal=Water+Eng.+Manag.&volume=144&pages=33%E2%80%9335](https://scholar.google.com/scholar_lookup?title=City+cuts+costs,+improves+accuracy+with+radio+frequency+meter+reading&author=Hastreiter,+J.&publication_year=1997&journal=Water+Eng.+Manag.&volume=144&pages=33%E2%80%9335)
6. [https://scholar.google.com/scholar\\_lookup?title=Annual+Report&author=Origin+Energy+Ltd&publication\\_year=2016](https://scholar.google.com/scholar_lookup?title=Annual+Report&author=Origin+Energy+Ltd&publication_year=2016)
7. [https://scholar.google.com/scholar\\_lookup?title=Annual+Report&author=Origin+Energy+Ltd&publication\\_year=2016](https://scholar.google.com/scholar_lookup?title=Annual+Report&author=Origin+Energy+Ltd&publication_year=2016)
8. <https://www.sciencedirect.com/science/article/abs/pii/S0264837711000172>
9. [https://scholar.google.com/scholar\\_lookup?title=Benefits+and+challenges+of+using+smart+meters+for+advancing+residential+water+demand+modeling+and+management%E2%80%9494A+review&author=Cominola,+A.&author=Giuliani,+M.&author=Piga,+D.&author=Castelletti,+A.&author=Rizzoli,+A.E.&publication\\_year=2015&journal=Environ.+Model.+Softw.&volume=72&pages=198%E2%80%93214&doi=10.1016/j.envsoft.2015.07.012](https://scholar.google.com/scholar_lookup?title=Benefits+and+challenges+of+using+smart+meters+for+advancing+residential+water+demand+modeling+and+management%E2%80%9494A+review&author=Cominola,+A.&author=Giuliani,+M.&author=Piga,+D.&author=Castelletti,+A.&author=Rizzoli,+A.E.&publication_year=2015&journal=Environ.+Model.+Softw.&volume=72&pages=198%E2%80%93214&doi=10.1016/j.envsoft.2015.07.012)
10. <https://www.sciencedirect.com/science/article/abs/pii/S0959652613003272>
11. <https://www.linkedin.com/pulse/smart-shower-meter-reduces-hotels-energy-consumption-susanne-h%C3%A4cki>
12. <https://www.ice.org.uk/knowledge-and-resources/case-studies/southern-water-universal-metering-project>
13. <https://iwa-network.org/eau-du-grand-lyon/>
14. <https://www.businesswire.com/news/home/20190612005891/en/Semtech-Supports-Deployment-of-Birdz%E2%80%99s-New-LoRaWAN%C2%AE-based-Water-Metering-Network>
15. <https://www.idrica.com/case-studies/>
16. <https://group.accor.com/en/commitment/planet-21/building>
17. <https://www.kamstrup.com/en-en/customer-references/submetering/case-alboa-housing-association>
18. <https://sustainablehospitalityalliance.org/>
19. <https://www.epa.gov/watersense/h2otel-challenge>
20. [https://www.london.gov.uk/sites/default/files/water\\_for\\_schools\\_case\\_study.pdf](https://www.london.gov.uk/sites/default/files/water_for_schools_case_study.pdf)
21. <https://wrap.org.uk/resources/water-efficiency-case-study/city-university-london>
22. <http://challisagplus.com/case-studytinderhoj-school-denmark-install-water-management-system-wms/>
23. <https://www.myswep.com.au/About>
24. <https://efdinitiative.org/news/smart-water-meters-south-african-schools-drive-down-water-wastage-saving-millions-rands>
25. <http://www.schoolswater.co.za/>
26. [https://scholar.google.com/scholar\\_lookup?title=Changes+in+water+consumption+linked+to+heavy+news+media+coverage+of+extreme+climatic+events&author=Quesnel,+K.J.&author=Ajami,+N.K.&publication\\_year=2017&journal=Sci.+Adv.&volume=3&doi=10.1126/sciadv.1700784&pmid=29075664](https://scholar.google.com/scholar_lookup?title=Changes+in+water+consumption+linked+to+heavy+news+media+coverage+of+extreme+climatic+events&author=Quesnel,+K.J.&author=Ajami,+N.K.&publication_year=2017&journal=Sci.+Adv.&volume=3&doi=10.1126/sciadv.1700784&pmid=29075664)



## Thematic Catalogue 4

27. <https://sensus.com/emea/resources/case-studies/influencing-human-behavior-reducing-peak-consumption/>
28. [https://www.researchgate.net/profile/Cara\\_Beal/publication/269818965\\_The\\_2014\\_Review\\_of\\_Smart\\_Metering\\_and\\_Intelligent\\_Water\\_Networks\\_in\\_Australia\\_New\\_Zealand/links/5497734a0cf2ec13375d3cea/The-2014-Review-of-Smart-Metering-and-Intelligent-Water-Networks-in-Australia-New-Zealand.pdf](https://www.researchgate.net/profile/Cara_Beal/publication/269818965_The_2014_Review_of_Smart_Metering_and_Intelligent_Water_Networks_in_Australia_New_Zealand/links/5497734a0cf2ec13375d3cea/The-2014-Review-of-Smart-Metering-and-Intelligent-Water-Networks-in-Australia-New-Zealand.pdf)
29. <https://www.hzjz.hr/sluzba-zdravstvena-ekologija/vodopskrba-i-upravljanje-rizicima-u-vodopskrbi-u-republi-ci-hrvatskoj/>
30. [https://www.google.com/search?q=smart+water+metering+system&tbm=isch&ved=2ahUKEwjJorz-\\_aD-yAhVm1uAKHTyiDFcQ2-cCegQIABAA&oq=smart+water+metering+system&gs\\_lcp=CgNpbWcQAzlCCAAyBA-gAEBg6BAgAEB5QhzhYkEBgsENoAHAAeACAAoBiAGvB5lBAzAuN5gBAKABAaoBC2d3cy13aXotaW1nwAEB&sclicent=img&ei=ED9GYMnaNOasgwe8xLK4BQ&bih=738&biw=816#imgrc=aKKJR5yZDGVwGM](https://www.google.com/search?q=smart+water+metering+system&tbm=isch&ved=2ahUKEwjJorz-_aD-yAhVm1uAKHTyiDFcQ2-cCegQIABAA&oq=smart+water+metering+system&gs_lcp=CgNpbWcQAzlCCAAyBA-gAEBg6BAgAEB5QhzhYkEBgsENoAHAAeACAAoBiAGvB5lBAzAuN5gBAKABAaoBC2d3cy13aXotaW1nwAEB&sclicent=img&ei=ED9GYMnaNOasgwe8xLK4BQ&bih=738&biw=816#imgrc=aKKJR5yZDGVwGM)
31. <http://www.os-nad-lipom-zg.skole.hr/ekoskola3.php>
32. <https://www.mdpi.com/2071-1050/9/4/582/htm>
33. <https://www.mdpi.com/2073-4441/11/4/838/htm#B20-water-11-00838>
34. <https://link.springer.com/article/10.1007/s11069-012-0456-2>
35. <https://www.tandfonline.com/doi/abs/10.1080/13504851.2011.629977>
36. <https://www.mdpi.com/2073-4441/10/11/1510/htm#B35-water-10-01510>
37. <http://www.infotrend.hr/clanak/2012/11/sto-to-mudri-rade-s--pametnim-mrezama-,75,960.html>
38. <http://www.infotrend.hr/clanak/2012/11/sto-to-mudri-rade-s--pametnim-mrezama-,75,960.html>
39. [https://www.gsma.com/iot/wp-content/uploads/2018/01/miot\\_smart\\_water2\\_02\\_18.pdf](https://www.gsma.com/iot/wp-content/uploads/2018/01/miot_smart_water2_02_18.pdf)
40. [https://www.iskraemeco.com/app/uploads/2020/10/IE\\_Smart-Water-Management-Solution.pdf](https://www.iskraemeco.com/app/uploads/2020/10/IE_Smart-Water-Management-Solution.pdf)



#### PROJECT WEBISTE

<https://www.interreg-central.eu/Content.Node/CWC.html>

#### SOCIAL MEDIA

<https://www.facebook.com/citywatercircles/>

<https://twitter.com/CirclesCity>

<https://www.instagram.com/citywatercircles/>

# City Water Circles

transnational online handbook on circular  
urban water management and use