



**Project Acronym:** S3UNICA

**Project Title:** Smart Specialisation UNiversity Campus

**Program:** Interreg Europe

**Topic:** Low carbon economy

**Specific Objective:** 3.1. Improving low-carbon economy policies

**Subsidy contract no.:** PGI06201

**Starting date:** 1st August 2019

**Ending date:** 31st July 2023



European Union  
European Regional  
Development Fund

**CAMPUS TECHNICAL  
SOLUTION  
PUBLICATION**

**Institute of Domotic and Energy  
Efficiency University of Málaga  
Andalusian Energy Agency**

# Index

1. Introduction.....	1
1.1.Andalusian Energy Agency.....	1
1.2.University of Málaga.....	2
1.3.University Institute of Domotic and Energy Efficiency.....	4
2. Campus activities.....	5
2.1.University of Malaga.....	5
2.2.University Institute of Domotic and Energy Efficiency.....	6
3. Innovative Technical solutions.....	12
3.1.University Institute of Domotic and Energy Efficiency.....	12
3.1.1. Good Practices.....	27
3.1.1.1. PV AND ENERGY EFFICIENCY AT FACULTY OF ENGINEERING AT THE UNIVERSITY OF MÁLAGA.....	27
3.2.University of Málaga.....	28
3.3.Andalusian Energy Agency.....	30
3.3.1. Good Practices.....	37
3.3.1.1. ENERGY EFFICIENCY ACTION PLAN AT THE UNIVERSITY OF GRANADA.....	37
3.3.1.2. Malaga Smart: Energy charging infrastructure, renewable energy and digitalization projects.....	38

Annexes

# 1. Introduction

## 1.1. Andalusian Energy Agency

### The Agency as an instrument for management and promotion

Created in 2005 as an instrument to **formulate and develop the energy policy proposals of the Andalusian Regional Government**, through the regional ministry with competence in energy issues.

#### Objectives

The Andalusian Energy Agency aims to:

- **Promote the use of autochthonous renewable energy sources, energy saving and efficiency actions and demand management** as measures to increase energy self-sufficiency, economic development, and environmental protection in Andalusia.
- **Promote and disseminate the principles of an energy culture** based on a **responsible and sustainable use of energy**.
- **Contribute** to the balanced land planning and to the **economic growth through an energy planning** that ensures a **safe, stable, diversified, efficient, and quality supply**.
- **Boost a competitive business network** through the promotion of **innovative energy technologies**.

#### Areas of action of the agency for the development of regional energy policy



## 1.2. University of Málaga

### Foundation: Citizen University

The history of the **University of Málaga** (UMA) cannot be understood without Málaga: the impulse of the **province** on all fronts (citizens, personalities and the media) **would prove to be key in the achievement of our university**. The process began in 1968 with the creation of the "*Association of Friends of the University of Málaga*": organized to ensure that the province had its own university, it managed to raise awareness of its importance in Málaga society and mobilize it until it was founded. From then on, a long process of progress began in which the creation of the University College of Málaga in 1971 and the grouping of the already existing School of Technical Engineers, Normal School, Faculty of Economics and Business Studies (at that time dependent on the University of Granada) and Seminary stood out.

Finally, on **18th August 1972**, by decree, **the foundation of the University of Málaga was approved**. The **Faculty of Economics and Business Studies and the Faculty of Medicine would be the first to form part of the global university that is today the University of Málaga**.

### Growth: More knowledge and infrastructures

With the aim of becoming a complete institution of the highest level, the **UMA developed an expansion plan** in terms of branches of **knowledge and infrastructures**. In this way, once settled in the **Campus of El Ejido**, it developed in the **university city of Teatinos**, an area that initially housed the Faculties of Medicine, Philosophy and Arts and Sciences, to **gradually grow and become an increasingly complete campus** in terms of both **academic offerings and university services**.

### Development: A qualitative leap

At the same time as the UMA was growing physically, it was also growing qualitatively: since the end of the 1990s, it has been **strongly committed to new technologies and research**.

In this sense, the University of **Málaga began a strategy to become a reference point for innovation and scientific development** in southern Spain. As a result, it designed an extensive collaboration framework with the Andalusia Technology Park, multiplied its national and international research projects and in 2007 joined the Spanish Supercomputing Network with the Picasso Supercomputer.

All this scientific and academic progress, together with the efforts of researchers, students, teachers, and administrative staff, led the **University of Málaga (together with the University of Seville) to be recognized in 2010 as a Campus of International Excellence, under the Andalucía Tech brand**.



## Recent years: More innovation and international character

Today, the University of Málaga continues to be committed to scientific development and innovation as a way to bring progress to society as a whole. During these years, the promotion of mobility and the effort to **attract international talent stand out**, achieving an **open, cosmopolitan university** that is capable of **integrating itself into scientific projects of the highest level**. 49 years later, it has **more than 40000 students, 58 Bachelor's degrees, 6 double degrees, 64 Master's degrees, 21 PhD programmes, 1248 administration and services staff, 2427 teaching staff in 17 schools and faculties, 70 UMA's own qualifications (master's and expert's degrees and lifelong learning) 278 research groups and 45 patents registered in 2011.**

**Innovation, dynamism, and internationalization** are the principles that mark the history of the UMA, and, in turn, the basis established by the university to overcome the current difficulties and strengthen its service for knowledge, for society and for the future.

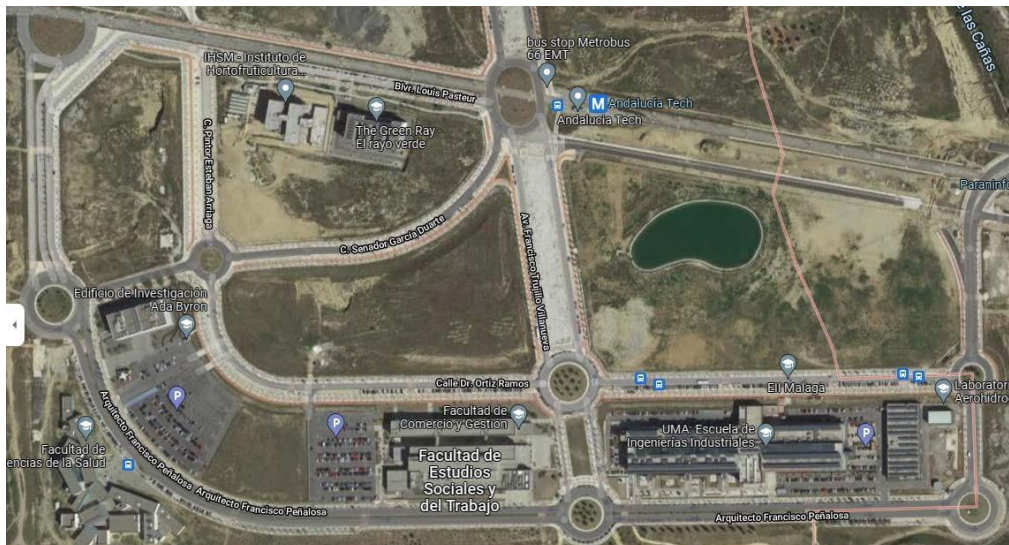

## 1.3. University Institute of Domotic and Energy Efficiency

The **Institute of Domotic and Energy Efficiency** is created at the University of Málaga (Governing Board on November 30 and endorsed by the Social Council of the University of Málaga on December 22, 2017). Subsequently recognized as an **Agent of the Andalusian Knowledge System**, by the Andalusian Council of Universities, on Friday May 17, 2019, being approved by the Governing Council of the Andalusian Government on June 4.

It is a Centre dedicated primarily to **research, training and advice to organizations and institutions with the aim of promoting, enhancing, and disseminating the use of Domotic and Energy Efficiency in industry in general and in relation to the energy sector, both at business and social level.** We are currently working in the fields of technology transfer to society of the advances achieved in the field of home and facilities Control, as well as Energy Efficiency. Our lines of research consist of **obtaining low cost devices that allow the whole society to have access to these devices**, making possible a very considerable **reduction of the energy needed to develop daily activities** and, in addition to the fact that only the energy needed is really used when it is needed, that improves the way of life of its users.

Another of the most important lines is **eHealth**: it aims to **enable people to live with peace of mind in their homes** by allowing their **health to be monitored in real time by their own home** (taking the necessary emergency relief actions in case of emergency). We are working along the lines of **enabling disabled people to access these technologies** and, for example, **health centres and hospitals to have intelligent driving systems for patients in their facilities** (automatic wheelchair driving).



## 2. Campus activities

### 2.1. University of Málaga

#### RESEARCH

- Cutting- edge technology and laboratories.
- Research centres and international research groups.
- 296 research groups.
- Portfolio of 240 patents.

#### INTERNATIONALIZATION

- 450 associated universities around the world.
- More than 500 international collaboration agreements.

#### CULTURE

- Music-visual and performing arts. (Communication and Exhibitions).

#### SPORTS

- More than 50 sports disciplines.

#### ENTREPRENEURSHIP

- Agreements with leading (R&D and technology companies).

#### FUTURE

- Agreements with 10,000 institutions and companies.



## 2.2. University Institute of Domotic and Energy Efficiency

The objectives of the developed activities (**conferences**) from Domotic Institute for knowledge diffusion of the innovative solutions has been the **research and dissemination of technologies leading to greater energy savings**, according to the guidelines set by the Interreg Europe S3UNICA project, aimed at seeking best practices in the use of energy.

All the **conferences** have been **organised by staff members** of the **Institute of Domotic and Energy Efficiency** and also has been aimed at **professionals in the sector and students of the Master in Domotic: Energy Management and Energy Management of Buildings**.

### CONFERENCES

#### Energy efficiency: rational use of energy

Number of participants (Part I): 0 on site + 85 online assistances

Number of participants (Part II): 0 on site + 125 on line assistances

These 2 conferences were managed by D. Juan Gámez Marmolejo, the expert from the company Circutor, who talked about **Technologies that allows audit and optimize the use of Energy in buildings and electrical installations**, specially focused on **Smart Grid Campuses**.

**Instituto Domótica y Eficiencia Energética**  
18:30 a 18:30 h.

**Jueves, 29 de octubre de 2020**

**Universidad de Málaga**  
**Eficiencia energética: uso racional de la energía.**  
D. Juan Gámez Marmolejo

**CIRCLUTOR**

Las personas o entidades interesadas en conocerse por teleconferencia deben solicitarlo a [info.uidee@uma.es](mailto:info.uidee@uma.es)

Colaboran:

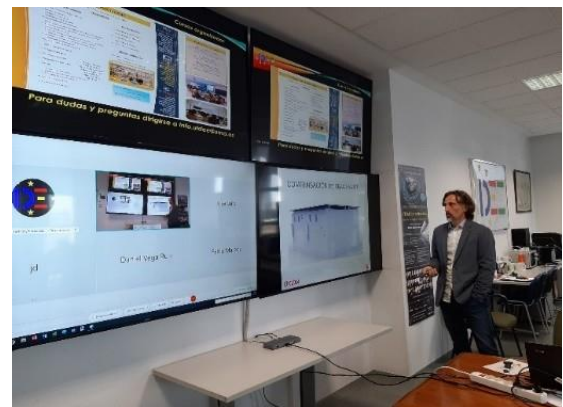



**Protection of electrical installation**

Number of participants: 0 on site + 155 online assistances

This conference was held by D. José Antonio Ramírez, the expert from the company “ABB”. The lecture was based on the operation of **differential and magneto-thermal systems that protect users and electrical installations especially focused on Smart Grid Campuses.**



**Energy efficiency in buildings Controls**

Number of participants: 0 on site + 110 online assistances

The expert from the company “Schneider Electric” D. Andrés Rivera Quero lectured the conference, that was focused on the **visualization and measuring systems about energetic consumptions on installations with distance connection specially focused on Smart Grid Campuses.**



**Electric vehicle charging equipment**

Number of participants: 0 on site + 120 online assistances

D. Juan Gámez Marmolejo, the expert from the company “Circuitor”, held the conference, based on descriptions about the **different kinds of electrical vehicle chargers, from 3 kw/h to 150 kw/h**, specially focused on **Smart Grid Campuses**. Actually, in all the faculties from the University of Málaga, are experimental electrical chargers, but in a **future**, in all the new buildings it will be installed in a huge number, permanently **electrical chargers**.

Instituto Domótica y Eficiencia Energética  
Universidad de Málaga (Spain)

Jueves, 3 de diciembre de 2020 16:30 a 18:30 h.

Universidad de Málaga  
**Sistemas de recarga de vehículos eléctricos.  
Instalaciones de autoconsumo.**  
D. Juan Gámez Marmolejo

Las personas o entidades interesadas en conocerlo por teleconferencia deben solicitarlo a [info.uides@uma.es](mailto:info.uides@uma.es)

Colabora: C I E C S



**Management solutions for digital building**

Number of participants: 6 on site + 53 online assistances

D. Andrés Rivera Quero, the expert from the company “Schneider Electric”, lectured about **software for the global management of the buildings**, specially focused on **Smart Grid Campuses**.

Instituto de Domótica y Eficiencia Energética  
Universidad de Málaga (Spain)

Jueves 10 de diciembre de 2020 16:30 a 18:30 h.

Schneider Electric  
**Soluciones de Gestión para El Edificio Digital**  
ANDRÉS RIVERA  
SCHNEIDER ELECTRIC

Las personas o entidades interesadas en conocerlo por teleconferencia deben solicitarlo a [info.uides@uma.es](mailto:info.uides@uma.es)

Colabora: C I E C S



**Software SCADA Circutor: Power Studio**

Number of participants: 5 on site + 65 online assistances

This conference was held by D. Juan Gámez Marmolejo, the expert from the company “Circutor”, and it was about **SCADA software** by the Company Circutor for the control of Energy Renewable Buildings and management of measure equipment. This will allow **audit in real time and energy production in the same**. This also is going to be focused on Smart Grid Campuses.

**Power studio**  
circutor.com

Jueves, 11 de marzo de 2021

Universidad de Málaga  
**Software de Gestión Energética.**  
D. Juan Gámez Marmolejo

Las personas o entidades interesadas en conectarse por teleconferencia deben solicitarlo a [info.uides@uma.es](mailto:info.uides@uma.es)

Colabora: CONECT, CIECS



**Radio-KNX display and control system. A complete KNX-radio solution**

Number of participants: 0 on site + 80 online assistances

This conference was managed by D. Antonio Alcaraz Sánchez, the expert from the company “Häger”, and it was based on **Control system by radiofrequency**. This solution is specially indicated for the **rehabilitation of existing buildings**, that is happening with all the University Campuses.

**Quicklink** **Coviva**

Sistema de programación KNX Plug and Play

Integración/visualización a través de dispositivos móviles

Conectando el universo de objetos digitales y servicios

Jueves 18 de marzo de 2021

Universidad de Málaga  
**Häger simplifica KNX: programación Easy y visualizador Domovea** Instituto Domótica y Eficiencia Energética  
18:30 a 18:30 h.

Las personas o entidades interesadas en conectarse por teleconferencia deben solicitarlo a [info.uides@uma.es](mailto:info.uides@uma.es)

Colabora: CONECT, CIECS



**Energy rating of buildings: Agardio solution**

Number of participants: 8 on site + 65 online assistances

This conference, held by the expert from the company “Häger”, D. Antonio Alcaraz Sánchez, focused on **Software and devices for the energy ratings of buildings**, developed by the Hager Company. This software is specially indicated for all the University Campuses.

UNIVERSIDAD DE MÁLAGA S3UNICA Interreg Europe IDE Instituto de Domótica y Eficiencia Energética Universidad de Málaga (España) Jueves 25 de marzo de 2021

**agardio.manager**  
Ver más, ahorrar más  
Monitorización inteligente de la energía.  
Para edificios más eficientes.

Universidad de Málaga  
Calificación de eficiencia energética con Agardio Manager de Häger

Instituto Domótica y Eficiencia Energética  
16:30 a 18:30 h.

Las personas o entidades interesadas en conectarse por teleconferencia deben solicitarlo a [info.uidede@uma.es](mailto:info.uidede@uma.es)

Colabora: CONICYT UNIC C I E C S



**Integration of climate control solutions**

Number of participants: 10 on site + 75 online assistances.

D<sup>a</sup>. Laura Rizo, the expert from the company “Airzone”, lectured this conference and further analysed the **Acclimatization control systems in ventilation and ducts grids** by the Airzone Company. This could be a **good solution for the Energy efficiency for the buildings from the Smart Grid Campuses**.

AIRZONE S3UNICA Interreg Europe IDE Instituto de Domótica y Eficiencia Energética Universidad de Málaga (España) Jueves 15 de abril de 2021

**Sistema de control de climatización Airzone**  
D<sup>a</sup>. Laura Rizo

Instituto Domótica y Eficiencia Energética  
16:30 a 18:30 h.

Las personas o entidades interesadas en conectarse por teleconferencia deben solicitarlo a [info.uidede@uma.es](mailto:info.uidede@uma.es)

Colabora: CONICYT UNIC C I E C S





**Connected Home: Low cost Domotic**

Number of participants: 10 on site + 55 online assistances

The Subdirector of the Institute of Domotic and Energy Efficiency D. Salvador Merino Córdoba conducted this conference based on **Low-cost devices for Domotic implementation in homes**, that could be easily applied in all the buildings from the University of Málaga and also to all the **University Campuses**.



**Smart buildings on the Engineering Institute**

The Director of the Institute of Domotic and Energy Efficiency D. Francisco Guzmán Navarro coordinated this conference based on the **application of Smart cities concepts on the Málaga University** like an **integrant part of the city**.

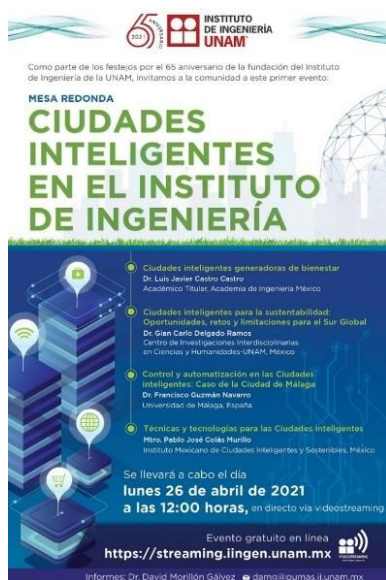

## 3. Innovative Technical solutions

### 3.1. University Institute of Domotic and Energy Efficiency

As one of its main lines of research since its creation, the UIDEE has been characterised by the use of low-cost technologies, both for use in domotics and always with energy efficiency in mind. For this reason, here below there are some of used devices (microchips):

#### Raspberry

It was born in 2011 through the **Raspberry Foundation**, which sought that every child in the world could have a low-cost computer (less than \$100). It is a motherboard that has all the necessary ports to **develop a complete computer**. The latest version (4B) allows us to up to 2 4K monitors and hard drive (via a Micro SD card) of any size. The current cost is approximately 50 euros (US\$60).



#### ESP8266 family

Born in 2014 by Expresssif (China). Its cost is approx. 0.2 euros (0.24 US\$). Operates between 3V and 3.6V and 80mA, with temperatures (-40oC,125oC). 3 Modes: Active-Sleeping (0.6mA-1mA)-Deep Sleep (20µA). From 2 digital outputs (ESP01) to 13 dig. +1 an. (NodeMCU) Preferred: ESP-201. Minimum size and price and 13 digital pins

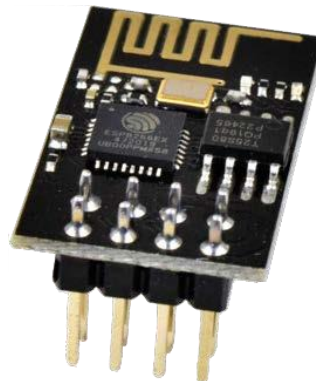

Such devices are used, for example, in:

**Control of access to dependencies by QR code**

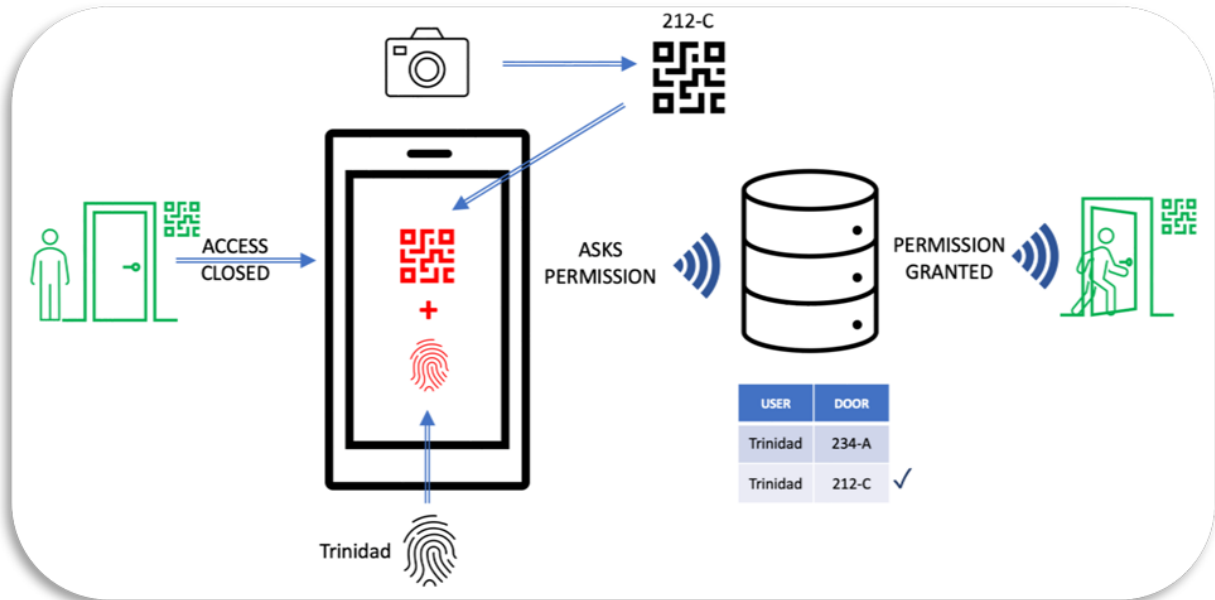

**Access Control II - Mod.Utility U201330626**

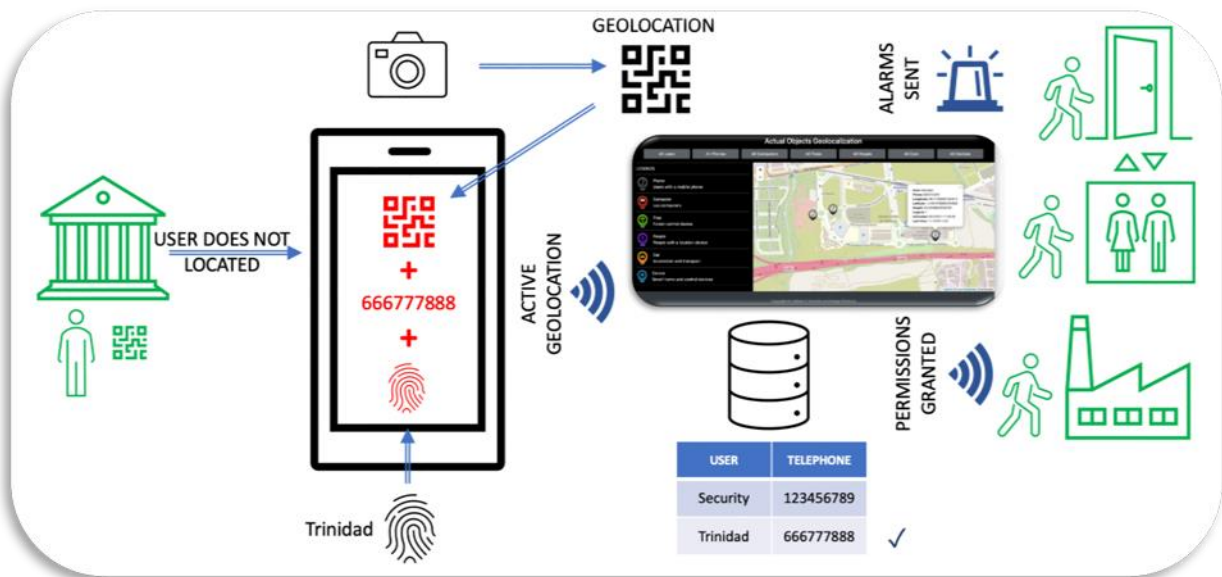

This is an evolution of the last idea.

## Controlling parking access

- Autonomous operation of barriers with periodic updating of data in them.
- Wireless communication from all barriers (both image and voice) with any phone or computer in the installation.
- Combined with license plate reader to verify authorization access to the vehicle.
- Combined with driver facial recognition to associate license plate with user.
- Real-time control of the number of vehicles inside and to whom they are associated (either by existing database or by driver facial recognition).
- It can be used in conjunction with the QR code access control app, read from the mobile, to identify the user and associate the vehicle license plate with them.
- Very low-cost installation with ID card savings, trench opening, conductors, and amplifiers.





## Control of fixed and mobile objects

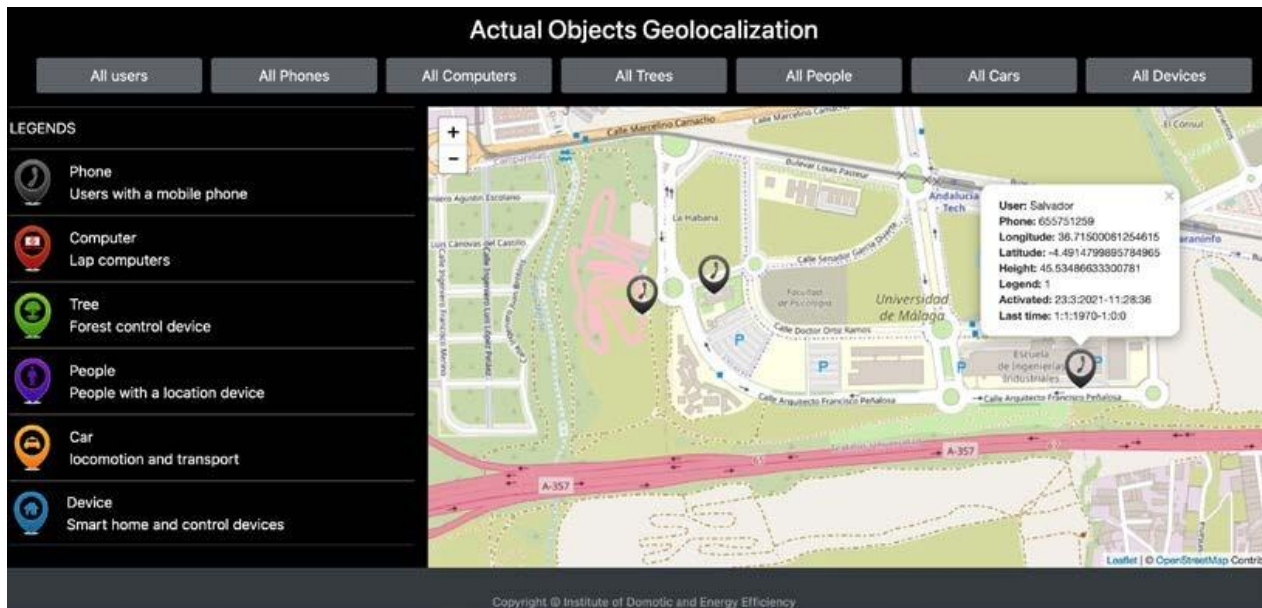

## ENERGY EFFICIENCY

This field is today one of the **priority areas in Europe and in the world**. It is of course also one of the fundamental reasons for our S3Unica project, which is why we have given it a special impetus during its development.

Here we will deal with topics as diverse as **climate control**, **cost reduction**, **electricity load sharing**, the **promotion of renewable energies**, and **cooperative micro grids**.

## Air conditioning with ventilation



This is our utility model that allows dual use of evaporative climatization. With it we can cool and heat installations by means of its support in solar and aerothermal energies and its distribution through air-water exchangers.

### Smart Plug - Patent P201531060

It is a European design, based on the German shucko, but with the **ESP8266** as an internal server to control market prices, consumption reduction, remote cut-off possibilities or efficient energy use.

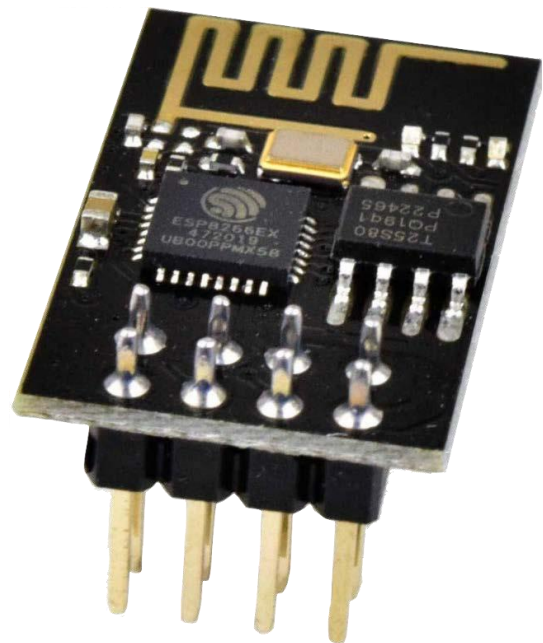



### Consumption control

This device plays a fundamental role in many of the projects developed by the Institute, as it is applied in the control of electric carloads, energy microgrids or balanced consumption.





### Community electric vehicle recharging system

- A single community accountant with 100% utilization.
- A single supply line per 30 chargers.
- Wireless authorization control and charging process.
- Tele management of the recharge process.
- Warning to phone when charging is complete.
- Possibility of charge for loading vehicles with priorities.
- Recharge charge to owners.

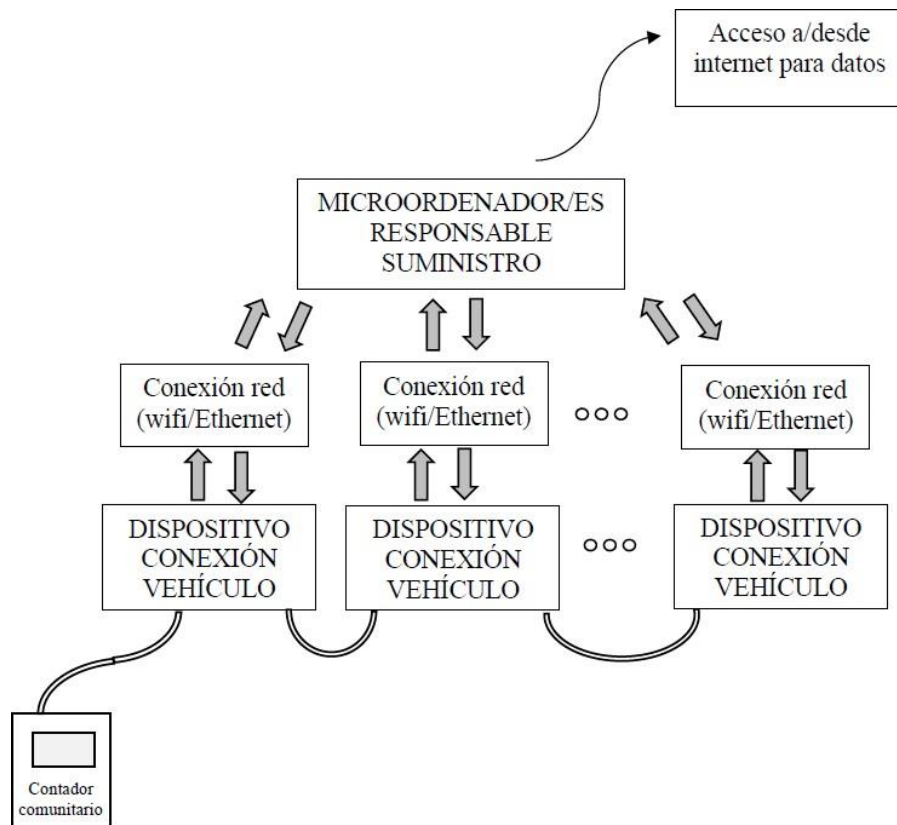



## High-performance water accumulator

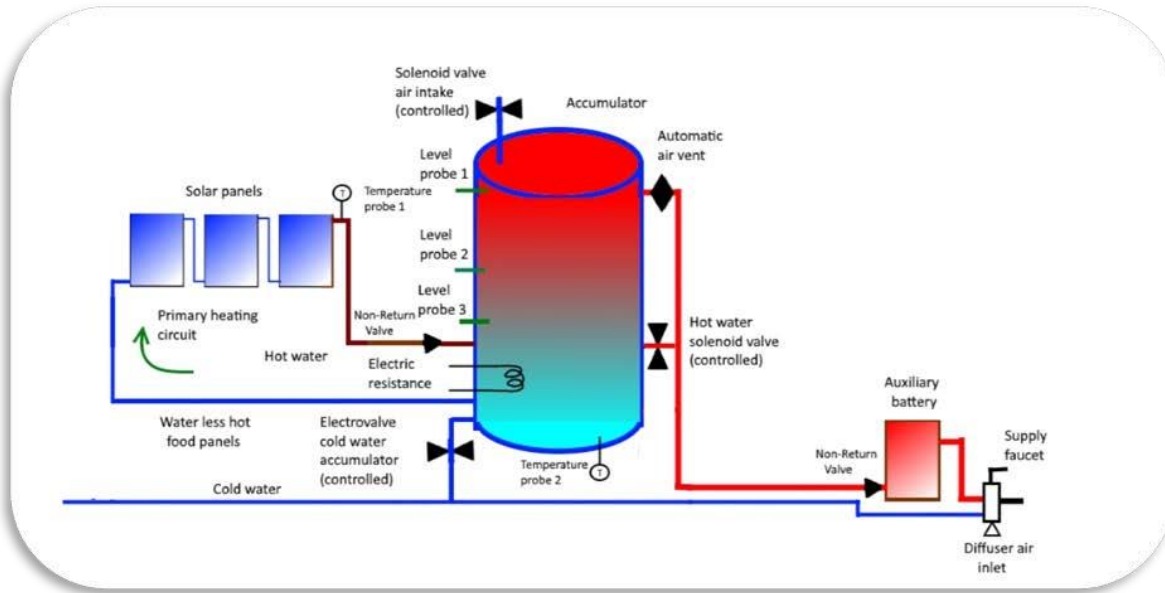

Nº SOLICITUD: P201700462  
 Nº PUBLICACIÓN: ES2627209  
 TITULAR/ES: UNIVERSIDAD DE MÁLAGA  
 FECHA EXPEDICIÓN: 29/12/2017

**TÍTULO DE PATENTE DE INVENCION**

Cumplidos los requisitos previstos en la vigente Ley 11/1986, de 20 de marzo, de Patentes, se expide el presente TÍTULO, acreditativo de la concesión de la Patente de Invención. La solicitud ha sido tramitada y concedida con realización del Informe sobre el Estado de la técnica y con examen previo de los requisitos sustantivos de patentabilidad.

Se otorga al titular un derecho de exclusividad en todo el territorio nacional, bajo las condiciones y con las limitaciones previstas en la Ley de Patentes. La duración de la patente será de veinte años contados a partir de la fecha de presentación de la solicitud (31/03/2017).

La patente se concede sin perjuicio de tercero y sin garantía del Estado en cuanto a la validez y a la utilidad del objeto sobre el que recae.

Para mantener en vigor la patente concedida, deberán abonarse las tasas anuales establecidas, que se pagarán por años adelantados. Asimismo, deberá explotarse el objeto de la invención, bien por su titular o por medio de persona autorizada de acuerdo con el sistema de licencias previsto legalmente, dentro del plazo de cuatro años a partir de la fecha de presentación de la solicitud de patente, o de tres años desde la publicación de la concesión en el Boletín Oficial de la Propiedad Industrial, aplicándose el plazo que expire más tarde.

Fdo.: Ana María Redondo Minguéz  
 Jefa de Servicio de Actuaciones Administrativas  
 (P.D. del Director del Departamento de Patentes e I.T., resolución 05/09/2007)

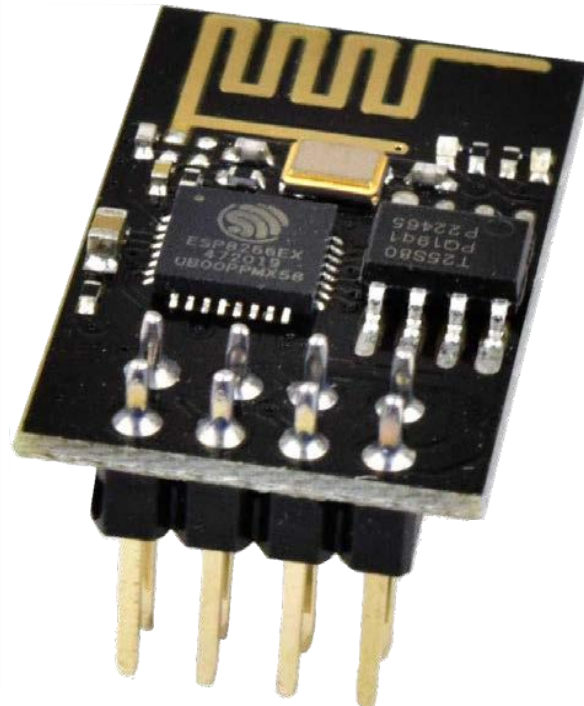

### Dynamic Phase Balancer (Patent P201531059)

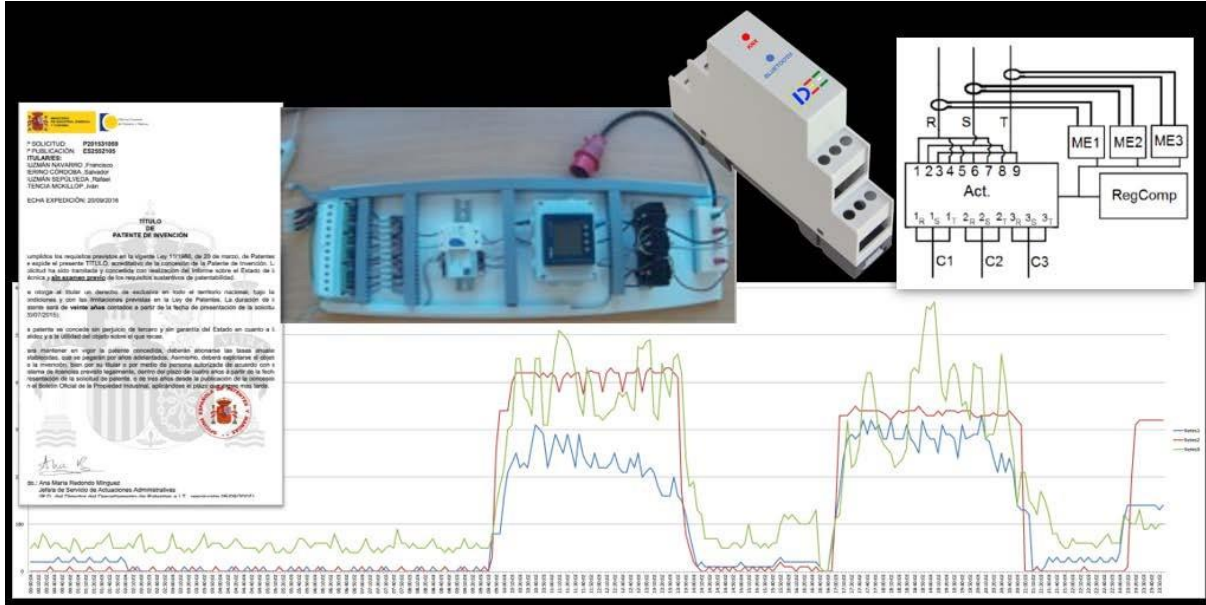

### Micro Grid

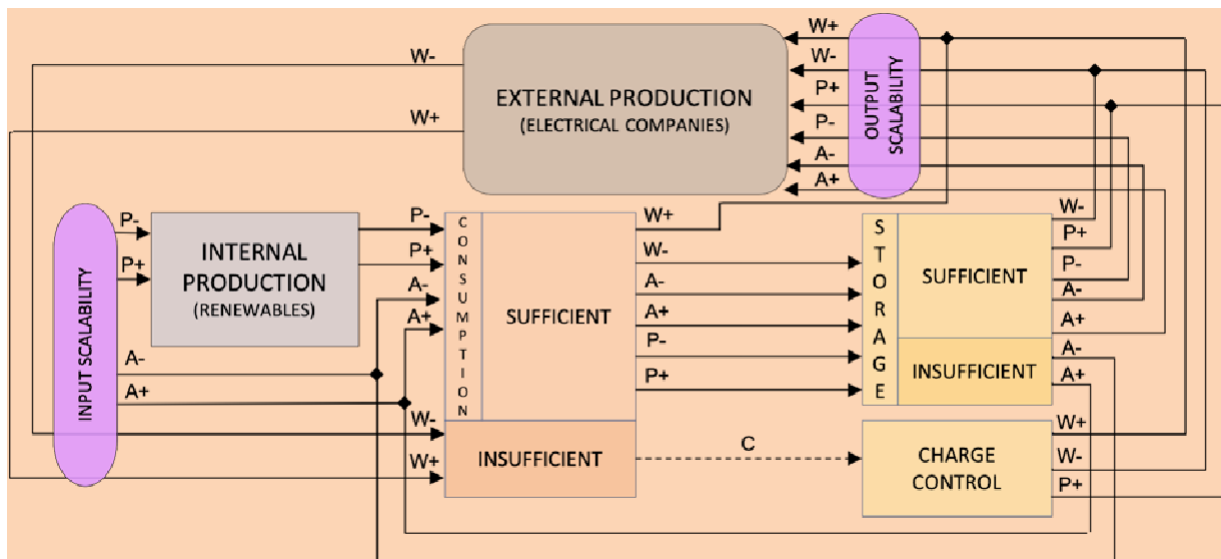



## MANAGING BUILDINGS AND HOMES

Just as energy efficiency is a basic line of research at our institute, Domotic fulfils the same function. In this sense, we have tried to develop various low-cost devices that, together with the control software, offer an elegant and simple solution for the general public.

In doing so, we aim to address one of the fundamental objectives that gave rise to the birth of the institute itself: **the generalization of the use of Domotic throughout society.**

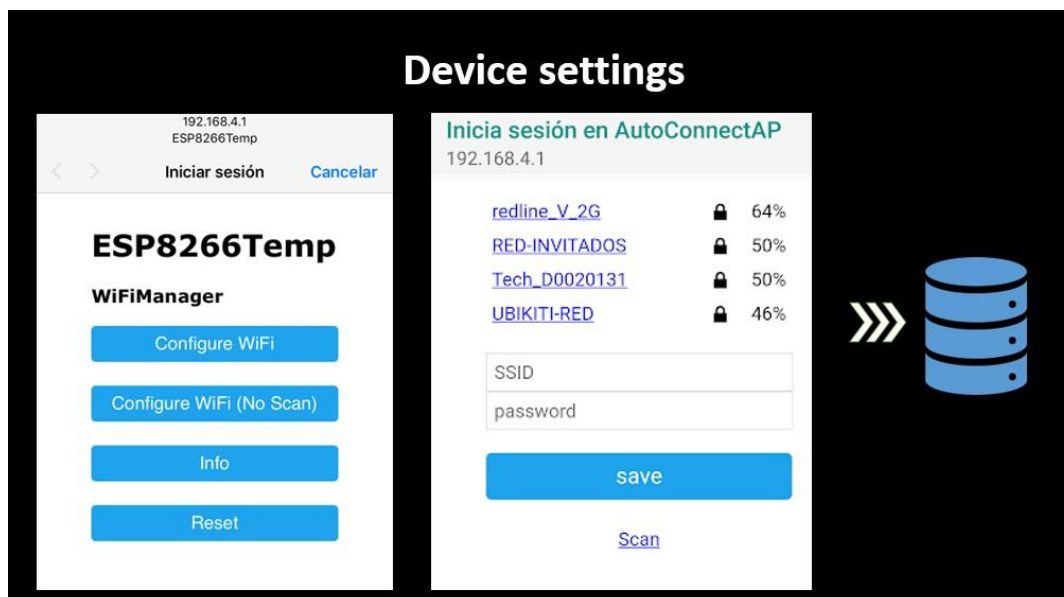



## IDEE Designer for Cube

Add new Item
Remove Item
Save data
Change image ▼

- 4 Rele-1
- 4 Rele-2
- 4 Rele-3
- 4 Rele-4
- Termostato
- 1 Rele
- 1 Rele

Planta 2

- Dormitorio 2
  - 4 Rele-1
- Vestidor 2
  - 4 Rele-2**
- Aseo 2
  - Termostato
  - 1 Rele
- Dormitorio 1
  - 4 Rele-3
- Vestidor 1
  - 4 Rele-4
- Aseo 1

Information: Clear

**4 Rele-2**

Description: Actuador de cuatro canales

Address IP: 192.168.0.101

Id - Pid: 3 - 25

Image: images/devices/device.jpg



## IDEE Designer for Cube

Add new Item
Remove Item
Save data
Change image ▼

- 4 Rele-1
- 4 Rele-2
- 4 Rele-3
- 4 Rele-4
- Termostato
- 1 Rele
- 1 Rele

Planta 2

- Dormitorio 2
  - 4 Rele-1
- Vestidor 2**
  - 4 Rele-2
- Aseo 2
  - Termostato
  - 1 Rele
- Dormitorio 1
  - 4 Rele-3
- Vestidor 1
  - 4 Rele-4
- Aseo 1

Information: Clear

**Vestidor 2**

Description:

Address IP:

Id - Pid: 25 - 8

Image: images/rooms/dressing\_room\_2-min.jpg



# IDEE Designer for Cube

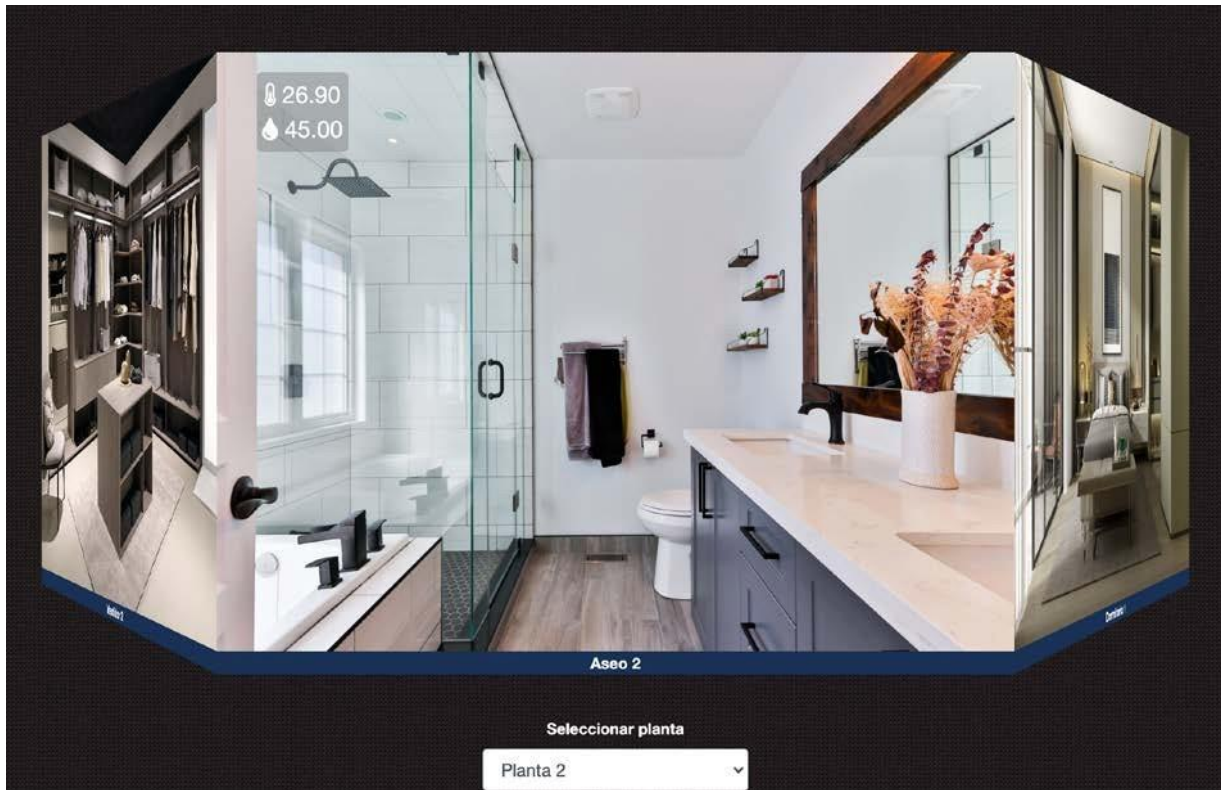
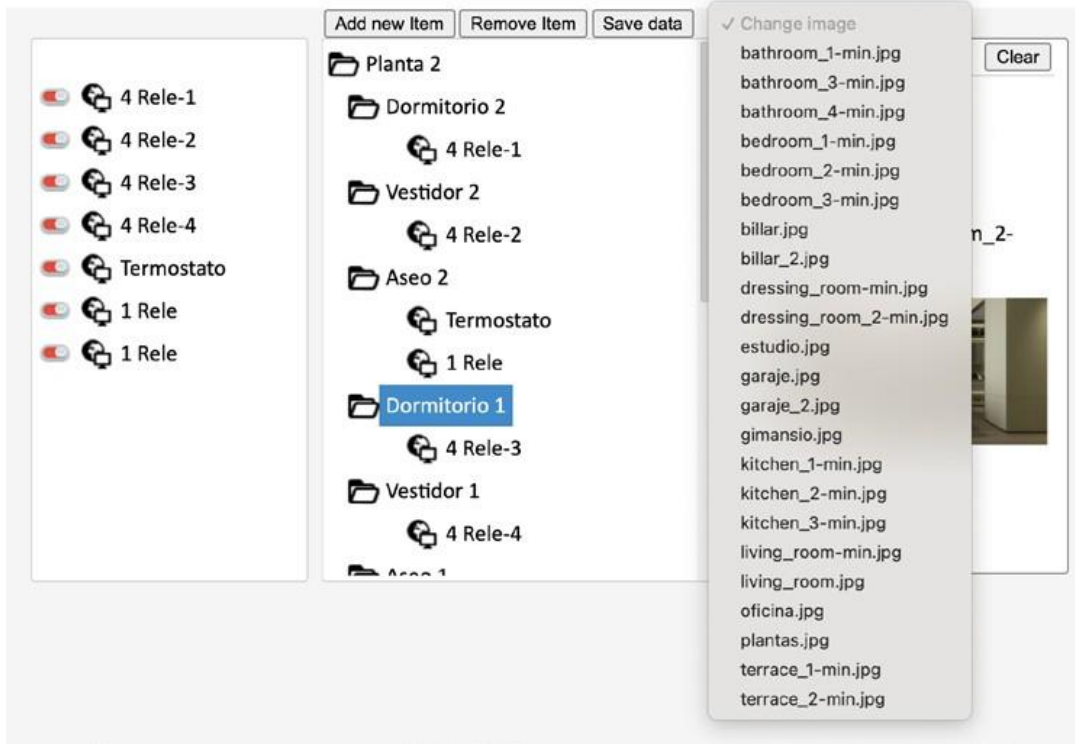

## E-HEALTH

The field of development that is likely to have the greatest future potential in Europe: when your own home takes care of your health.

In this respect, the ageing of the population offers us the possibility of adapting our homes so that every citizen can be medically monitored without having to go to hospital or be transferred to a nursing home.

The devices developed here are more expensive and take longer to develop, and many of them are the future lines of research that we are starting today.

### MOST AVANCED DEVICES: iPhone + Apple Watch





**IDEE CENTRALIZED E-HEALTH SYSTEM**



In this part of our work, we include the standard router how central node of communications and its relationship with a medical centre and insurance companies.

**LOW-COST VEHICLE CONTROL I**

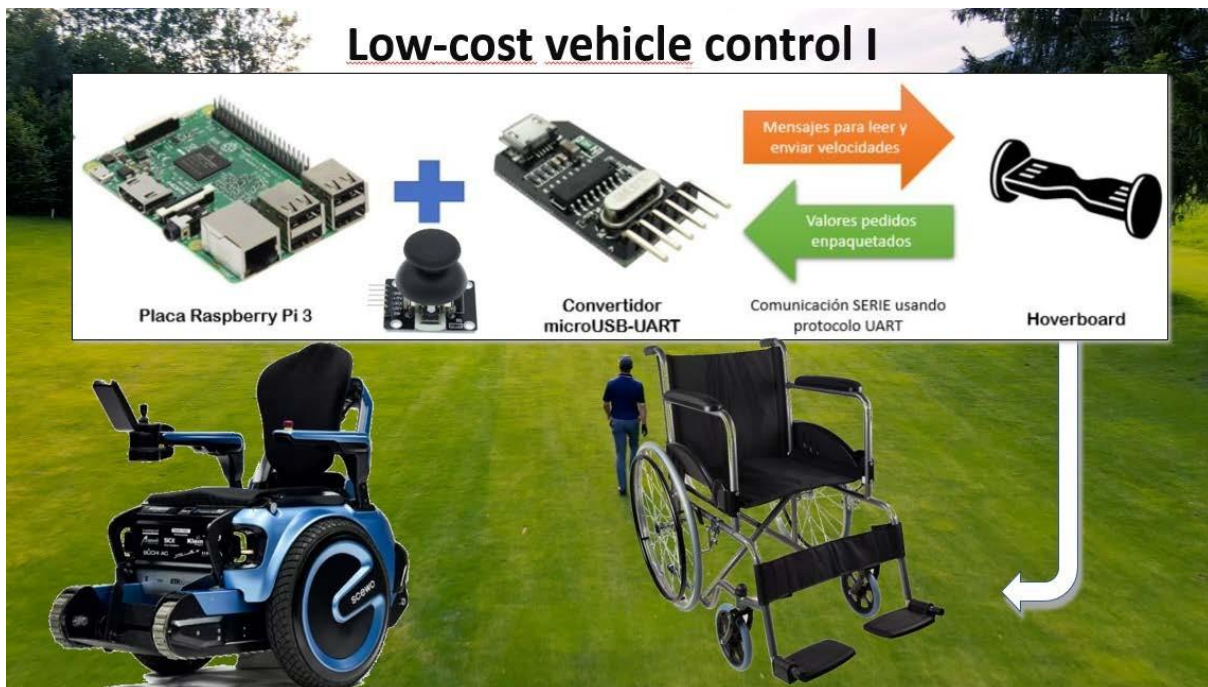

## LOW-COST VEHICLE CONTROL II

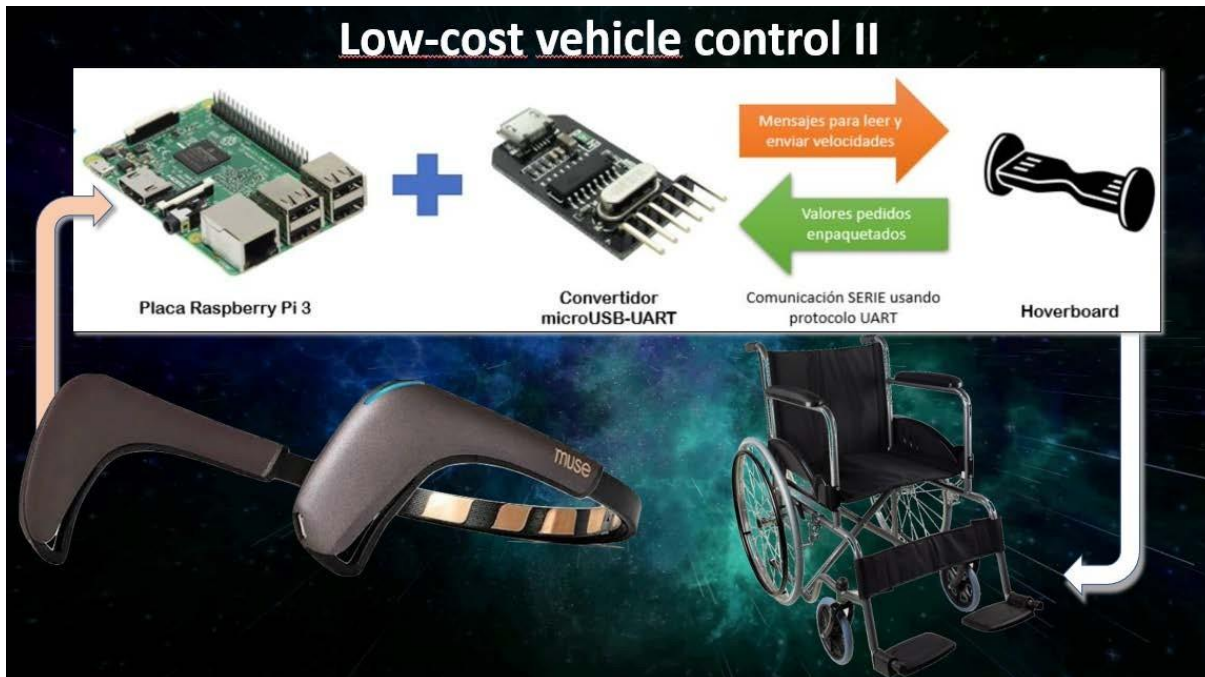

## FUTURE OPTIONS

The main ideas, that we expose here, are the future of our research:

- Multiple protocols
- IFTTT
- Commands via IP
- Industrial control (5G)
- KNX:
  - Through the programming already developed.
  - Voice control

## 3.1.1. Good Practices

### 3.1.1.1. PV AND ENERGY EFFICIENCY AT FACULTY OF ENGINEERING AT THE UNIVERSITY OF MÁLAGA

This practice shows **energy sustainability of the School of Industrial Engineering of the University of Málaga** optimizing their control and maintenance.

With the intention of achieving a sustainable, ecological and highly efficient university campus, the University of Málaga has drawn up a **Sustainability Master Plan** that will be gradually applied to **both new- build buildings and existing buildings** and open areas of the campus.

The **School of Industrial Engineering** is a project aimed at **achieving a university complex** with the **highest energy rating**. For this, two fundamental concepts are combined: the **production of electrical energy using renewable energies**, and the **implementation of home automation control systems** that allow **optimizing both the energy required** and the **management of its facilities**.

With the first objective, a total of **1 MW** have been installed **on their roofs**, using **230 W monocrystalline panels**. This system was implemented to produce an average of **704 kWh / year**, which more than met the energy needs of the building when the activity carried out in it coincides, for the most part, with the hours of sunshine at this latitude.

For the second proposed objective, there is a **LonWork system** using a **Building Management System** that allows **controlling the air conditioning and lighting**.

The objective, from the energy point of view, is to achieve the **self-sufficiency of the facilities** and, even, to be able to **transfer energy to other neighbouring buildings**.

The **beneficiaries** are the university community, **4,500 students from 12 engineering specialties**, **140 professors** and **140 administration and services staff**.

#### Resources needed

**€ 300,000.00** during **2021** and **€ 2,700,000.00** for the **next 5-year period**.

The School of Engineering was built with the University of Málaga's own funds and the installation of photovoltaic energy was paid for by a private company in exchange for the exploitation of the production of energy



### Evidence of success

The project is currently producing **1,297,613 kWh / year** and **avoids 1,300 tons / year of CO2**.

### Difficulties encountered

The Faculty of Engineering is part of the Smart Campus Málaga an ambitious and integrated plan that will be developed over a long time period. In addition, due to the lack of rain in this area, it was necessary to opt for the use of **dry gardens in order to optimize resources**.

### Potential for learning or transfer

The **experience is fully replicable in other universities**. The experience gained will make it possible to **optimize the available resources in each area** as well as make it possible to **achieve sustainable campuses**, from an **energy and environmental point of view**. Likewise, it is possible to **optimize the response of the maintenance and support services** both to **infrastructures** and to the **personnel** who carry out their activity in the university buildings.

## 3.2. University of Málaga

Imagine an open university that integrates into urban life, interactive public spaces that promote **conversations between disciplines, technologies and digital interfaces that boost knowledge sharing**, in a **natural, bioclimatically conditioned environment**, creating **connected spaces** that enhance the **exchange between students, faculties, and visitors**.

The main boulevard at the University of Málaga connects existing facilities open to the campus to the public (**CONNECTED**), creating a walkway activated by hubs or public squares by learning and measuring spaces (**OPEN**), incorporating technology to create interactive urban environment connected to the digital world (**INTERACTIVE**), an ecological corridor that efficiently reaches resources creating diverse natural landscapes (**GREEN**).

It will be an **interactive, open, connected, and green campus**, an **intelligent natural space** with a positive energy balance and bioclimatic comfort. A public space with collaboration, creativity and learning defines the urban seen.

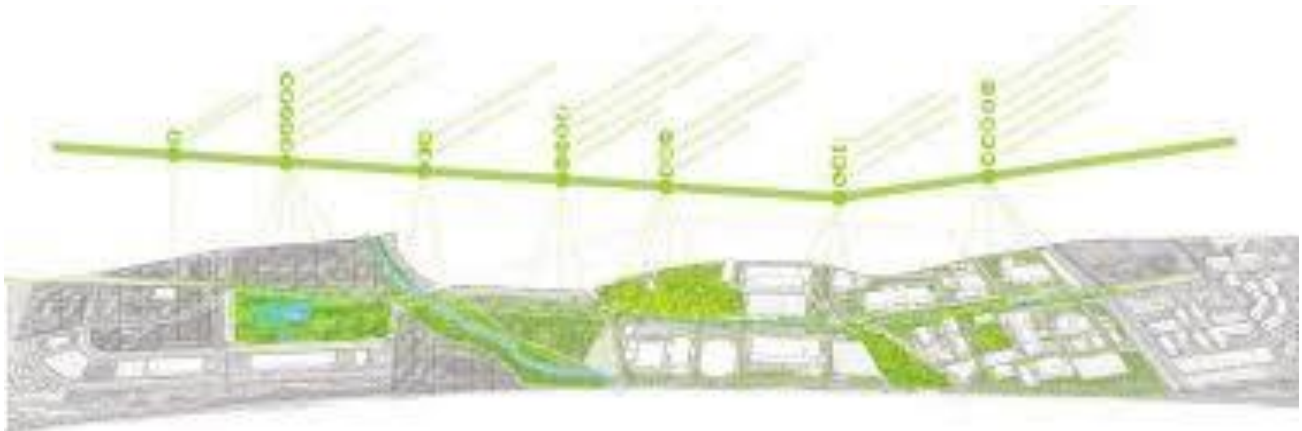

### 3.3. Andalusian Energy Agency

#### Andalusia and its potential in renewable resources

In last years, Andalusia has demonstrated its great potential in renewable resources:

- between 2007 and 2019, electric power with renewables has been multiplied by about 5.
- During this period, the growth of **wind, solar thermal and photovoltaic power is highlighted, which represents 20%, 6% and 11 % respectively of the installed power 2019.**

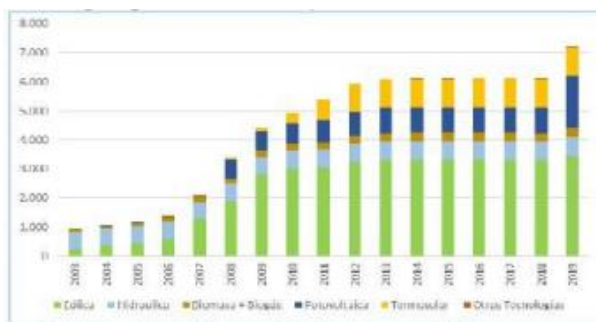

Evolution of installed renewable electric power (MW)



Energy infrastructures in Andalusia

#### Renewable energy for Andalusia in the near future

In more details, Andalusia's objectives are:

- **26,000 new MW of installed renewable power in 2030, to achieve, at least, 45% of the objectives of the National Energy and Climate Plan.**
- **Investments of more than 17,000 million euros** associated with renewable energy projects that can be implemented in Andalusia.
- **Achieving the objectives of the National Energy and Climate Plan.** Since that requires a robust electricity transmission network, the Andalusian Regional Government has elaborated and submitted an **ambitious development network proposal to the Ministry** last June 2019.





## Energy and Innovation: Regional context of Andalusia

Andalusia: Competitive Advantages

- **Important growth of renewable energy** in recent years which has generated a new business field. The sector as a whole is formed of more than **6,500 companies (25.3% of all companies)** in the energy sector), that generate more than **43,000 jobs (30.6% of all jobs)** associated with the energy sector).
- **World leader in some areas and technologies of renewable energy**, such as solar energy, biomass and biofuels.
- **Experience in the implementation of a wide set of programmes** aimed at fostering renewable energy, with an important number of companies, some of them being leaders in their field.
- **Experience in the construction sector**, with a **high volume of skilled workers** in the different industries linked to it and several centres and research groups with experience in the development of new material, such as multifunctional, ceramics or micronized marble that play an important role in knowledge transfer and technology with the sector.
- **Research centres of reference** in these areas, such as the **Solar Platform of Almería** - considered as one of the most important technological research centres in the world; as well as the **Solúcar Platform in Sanlúcar la Mayor** (Seville).

- **Important growth of renewable energy** in recent years which has generated a new business field. The sector as a whole is formed of more than **6,500 companies (25.3% of all companies in the energy sector)**, that generate more than **43,000 jobs (30.6% of all jobs associated with the energy sector)**.

**Smart Specialisation Strategy on Energy**



- ➔ Development of land and marine renewable energy
- ➔ Energy smart grids
- ➔ High capacity systems of energy storage
- ➔ Energy efficiency in businesses, houses and institutions
- ➔ Energy sustainability in rural areas
- ➔ **New construction designs and materials and sustainable processes**

Objetivos energéticos:

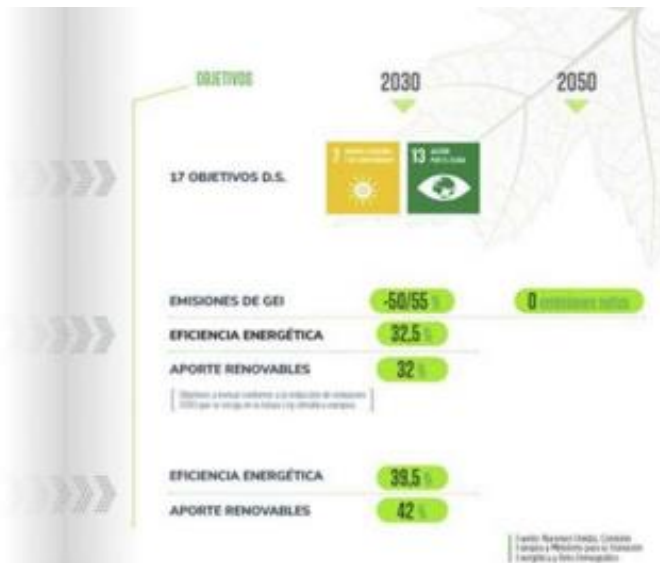

## Energetic objectives



## Sustainable Buildings Partnership

### Sustainable Buildings Partnership



<https://s3platform.jrc.ec.europa.eu/sustainable-buildings>



**Eco-construction, bioclimatism and insulation of buildings**  
Leader Topic 1. Cluster Digipolis, Lapland Finland

**Renewable energy integration in buildings**  
Leader Topic 2 Regione Autonoma Friuli Venezia Giulia, Italy

**Systems of maximum energy efficiency in buildings and cities**  
Leaders Topic 3. IVE Institute Valenciano de la Edificación, Spain and TECES Energy Conservation and Energy Efficiency Cluster, Podravska, Slovenia

**Current Composition**  
Participants: 55 entities from 45 different regions / Member States

- 38 regional administrations
- 3 national administrations
- 3 local administrations
- 8 universities
- 3 businesses

**45** REGIONS AND MEMBER STATES

**Leader:** Andalusian Energy Agency, Spain  
**Co - Leaders:** LENERG, North Great Plain Hungary and REGEA, North Croatia Energy Agency

Andalusia (ES)



**Sustainable Construction, a priority sector in Andalusia**

Interregional Partnership in Sustainable Buildings, Andalusia is leading this Partnership.



**S3UNICA consortia**



**S3UNICA General Data**

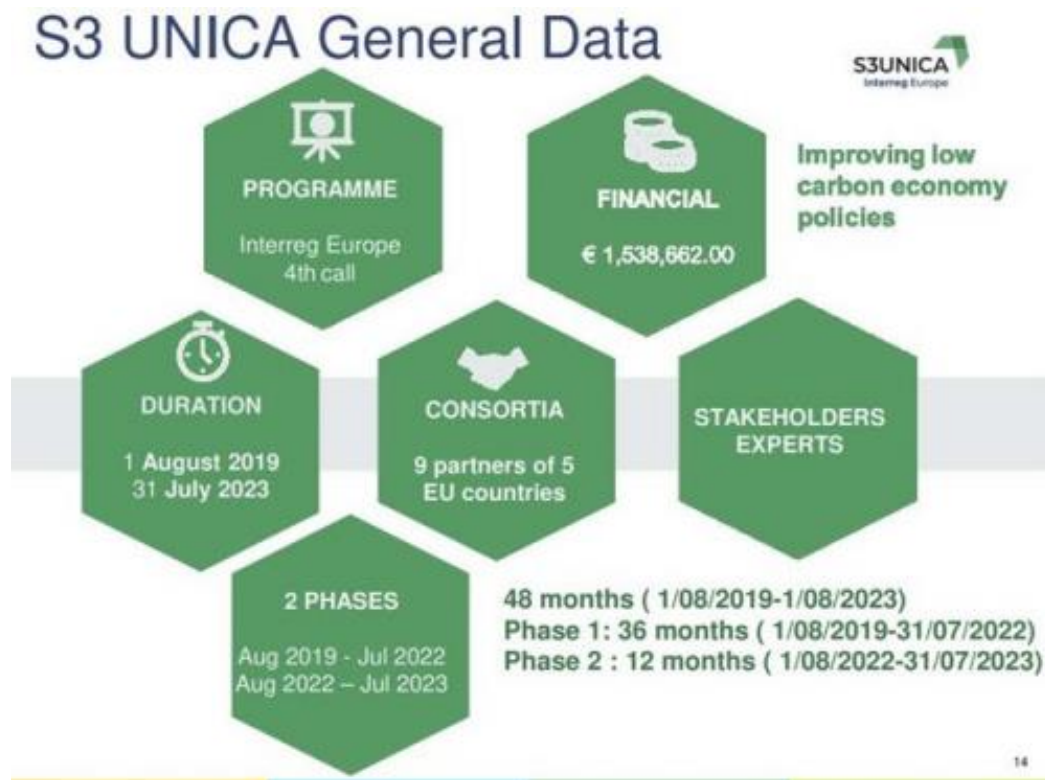

**S3UNICA project deliverables**

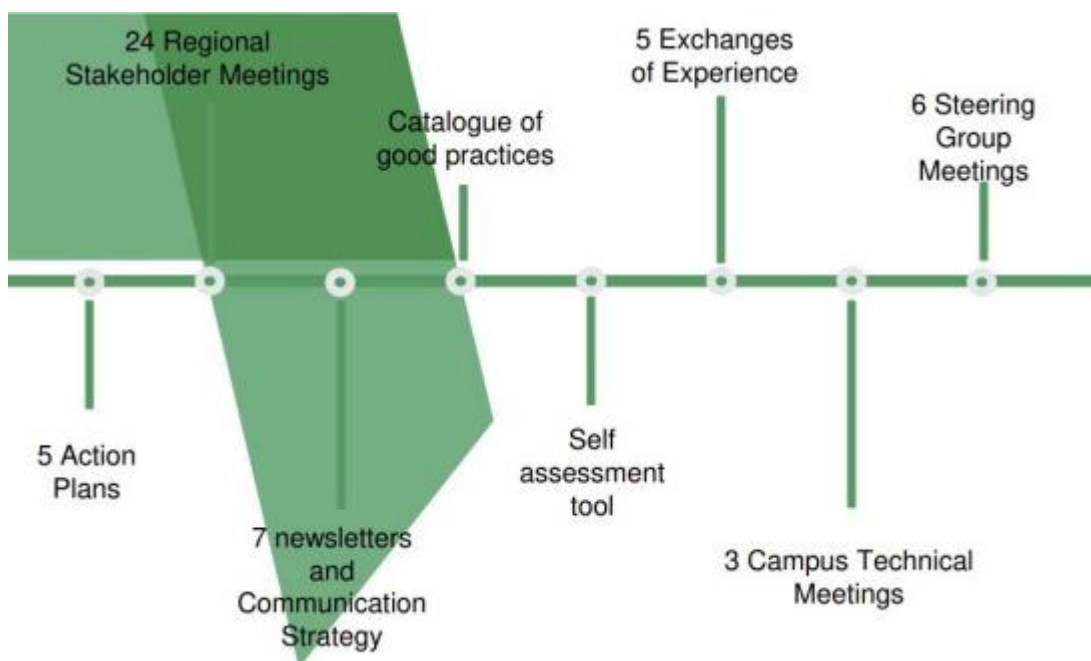

**S3UNICA ANDALUSIAN REGIONAL STAKEHOLDERS**



**INSTITUTIONAL:**  
**Managing Authority, General Directorate of European Funds;**  
**REDEJA Energy Network of the Andalusian Government;**  
**Andalusian Agency for Innovation and Development IDEA Agency;**  
**Andalusian Knowledge Agency,**  
**Andalusian Federation of Municipalities and Provinces**  
**PUBLIC-PRIVATE PARTNERS AND CLUSTERS**  
**Technological Corporation of Andalusia**  
**Cluster Andalusian Smart City,**  
**RESEARCH CENTRES**  
**INTA National Institute of Aerospace Technology**  
**UNIVERSITY CAMPUSES**  
**10 Andalusian Public Universities**  
**COMPANIES**  
**energy companies**  
**ASSOCIATION OF CONSUMERS AND USERS**

**ANDALUSIAN REGIONAL STAKEHOLDERS GROUP TASKS**

**Constitution of an Expert Committee**

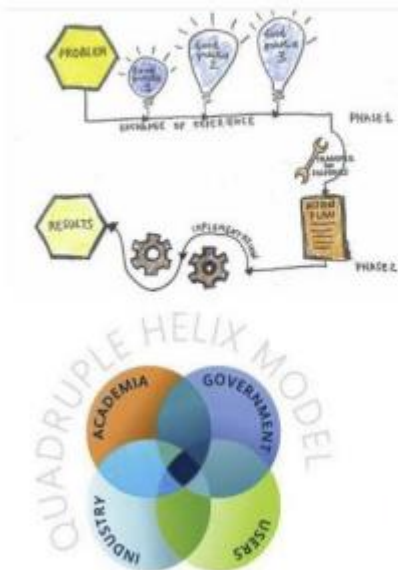

**Participation at Regional Stakeholder meeting each 6 months where informed on project development:**

- as 28<sup>th</sup> January 2020,
- 8<sup>th</sup> July 2020,
- 19<sup>th</sup> January 2021,
- next in July 2021

**Participation at Exchange of Experiences as:**

- On-line 17<sup>th</sup> June 2020 in Finland,
- On-line 27<sup>th</sup> January 2021 in Andalusia,
- next On-line 24<sup>th</sup>-25<sup>th</sup> June 2021 in Italy.

**Participation in communication's action:**  
**Newsletter, web page and articles**

**Testing the Self-Assessment Tool at the University of Cádiz, Córdoba, Granada and Málaga and others.**  
**Testing the Smart Readiness Indicators SRI.**  
**Elaboration of Best Practice**

**Elaboration of Andalusian Action Plan**



### 3.3.1. Good Practices

#### 3.3.1.1. ENERGY EFFICIENCY ACTION PLAN AT THE UNIVERSITY OF GRANADA

It is a procedure for **optimization and energy saving in the different buildings of the University of Granada**. The University of Granada has a wide estate of **122 buildings**, and a constructed area that amounts to **616,394 m<sup>2</sup>**, and has **7 University Campuses**, where continuous **improvement in terms of energy efficiency** is very important. The problem is the high energy expenditure and emissions, and for this reason an Energy Efficiency Action Plan was carried out.

It has a **district air conditioning for cooling and heating**, which serves 76,650 m<sup>2</sup> on the Health Sciences Technology Park Campus.

**The University of Granada has 100% renewable energy certified through REDEJA the Energy Network of the Junta de Andalucía's Government.**

It starts with **energy audits in the different buildings**, and from them, energy saving measures are **implemented according to their economic, technical and energy viability**. These include, among others, the following areas of action:

- Change of **luminaires to led**.
- Change of **heating fuel**.
- Replacement of **windows**.
- Monitoring of **facilities**.

#### Who are the main stakeholders and beneficiaries of the practice?

More than **3,677 teachers**, **53,190 students** and **2,616 administration and services personnel** benefit from the current project.

#### Resources needed

Average of 1,000,000 € per year from own funds of the University of Granada's are invested directly in energy saving, implemented through different tenders and also with its own maintenance personnel.

#### Evidence of success

Since this methodology began to be put into practice, the change of lighting, the change of fuel in heat production and the change of windows, among others, has been promoted.

To date, these results achieved are estimated as follows::

- Energy saved: 892,858 kWh / year
- Emissions avoided: 441.64 Tn CO<sub>2</sub> / Year
- Total equivalent trees planted 11,300 trees /year

### Difficulties encountered

The main challenges are to obtain the **financing, the size of the institution, the number of buildings and interlocutors** to implement a **system**, and prior to the **installation of the control system**, also the **lack of data and measurements**.

### Potential for learning or transfer

The main strength of this practice is that it is a **method of continuous improvement**, and therefore, although they are **partial actions in the buildings**, they do not stop having a **cumulative result** throughout the **useful life of the property**, allowing thus constantly **improve its energy demand**.

The energy savings figures shown are for all the actions that have been implemented at the University, showing a considerable reduction in the energy required annually as a whole.

## 3.3.2. Malaga Smart: Energy charging infrastructure, renewable energy and digitalization projects

This best practice explained the implementation's actions of the Málaga Smart: **energy charging infrastructure for e.v, res and urban digitalisation**. A City with more than population of 578,000 inhabitants with strong commitment with energy through the Málaga Smart Plan, including:

- **Plan for Electric Vehicle Mobility in Málaga** consisting in **transferring public land for private use** to install, maintain and operate a **public electric vehicle (EV)** recharging network in the City of Málaga. 30 electric chargers are under deployment.
- **Implementation of Photovoltaics in roofs** with 43 already implemented facilities and 24 new plants scheduled for 2021 and 2022. The generation from the new plants is estimated at around **1600 kWp** as well as a project under study of a **Solar Park for self-consumption of 10 to 30 MW**.
- **"SMART COSTA DEL SOL"** project is implementing a **Smart Platform and control panel** under an **Open Data portal** together with **12 municipalities** of the **Costa del Sol** co-operating in an initiative that demonstrates the use of technology as a resource optimizer for local entities.

- **“INTELLIGENT BUILDINGS PILOTS” (CENTESIMAL) initiative is the deployment of sensors in 218 buildings** (8 at the University) for several use cases. Each building contains an **IoT node**. This integrated IoT network provides the **information to a smart city platform**. Like: Primary care: “Heart Attack Button” App + defibrillators location, Reduction of electricity consumption in buildings, public lighting remote management and automation, Urban climate and air quality data treatment, or Location of EV chargers and parking lots, amongst others.

### Who are the main stakeholders and beneficiaries of the practice?

More than **3,677 teachers**, **53,190 students** and **2,616 administration and services personnel** benefit from the current project.

This practice shows **energy sustainability of the School of Industrial Engineering of the University of Málaga** optimizing their control and maintenance. With the intention of achieving a sustainable, ecological, and highly efficient university campus, the University of Málaga has drawn up a Sustainability Master Plan that will be gradually applied to both new-build buildings and existing buildings and open areas of the campus.

The **“School of Industrial Engineering”** is a project aimed at **achieving a university complex with the highest energy rating**. For this, two fundamental concepts are combined: the **production of electrical energy using renewable energies**, and the **implementation of home automation control systems that allow optimizing both the energy required and the management of its facilities**.

With the first objective, a total of 1 MW has been installed on their roofs, using 230 W monocrystalline panels. This system was implemented to **produce an average of 704 kWh/year**, which more than met the energy needs of the building when the activity carried out in it coincides, for the most part, with the hours of sunshine at this latitude.

For the second proposed objective, there is a **LonWork system using a Building Management System** that allows **controlling the air conditioning and lighting**.

The objective, from the energy point of view, is to **achieve the self-sufficiency of the facilities** and, even, to be able to transfer energy to other neighbouring buildings.

The beneficiaries are the university community: **4,500 students** from **12 engineering specialties**, **140 professors**, **140 administration and services staff**.



# Annex 1

## Self-Assessment Tool questionnaire

# S3Unica - Interreg Europe Self Assessment Tool questionnaire

---

## INTRODUCTION

S3UNICA project is based on the methodology adopted by the Smart Campus Interregional Innovation Pilot Action project which established a classification of partners' University Campuses and provided basic information about the dimension and the localization of technologies that have been adopted or are still in the testing phase. The main goal of the Smart Campus project was to develop the concept of smartness at University Campuses in the partnership regions: this should lead energy generation, distribution systems and energy use in university buildings in a more efficient and innovative way, in University Campus Buildings as far as technical, financial and planning aspects are concerned.

## S3UNICA aims to:

- capitalize the experience gained by Smart Campus project partners (PPs);
- extend the acquired outputs to new PPs (Romania and Poland);
- develop a common vision based on the quadruple helix approach, according to Directive (EU) 2018 /844 of the European Parliament and of the Council of 30 May 2018 on the energy performance of buildings and the Smart Readiness Indicator, in order to improve policy instruments through the adoption of action plans

S3UNICA activities will be developed on the basis of the following 3 steps:

1. **"Identification and Analysis"**: development of the self-assessment tool first part enabling regional stakeholders to identify their strengths and weaknesses on the innovation cycle, policy framework, technical and financial performance;
2. **"Interregional mutual learning"**: after the first step, S3UNICA will plan strategies, technical solutions, policy framework and ecosystem of the beneficiary region in order to increase smart energy saving, to improve distribution and production measures, as well as methods, resources, results and acquired experience throughout the innovation cycle;
3. **"Knowledge transfer and action plans"**: given the lessons learnt from the Smart Campus project partners and considering the rich experience acquired by the new S3UNICA partners experienced, a common methodology will be drafted to support the growth of transnational markets by identifying action plans.

The assessment tool includes the above mentioned steps 1 and 2 and it will be implemented in two phases: The first phase will be approved during the first Steering Group (SG) and it is the subject of this document: it pursues the goal of collecting information in order to allow stakeholders to identify their strengths and weaknesses and of gathering quantitative data to build the next phase;

On the basis of the information received, the second phase will aim to define a common methodology to select technological roadmaps and the most appropriate policies.

The table below summarizes the implementation of the project activities:

	M0	M1	M2	M3	M4	M5	M6	M7	M8	M9	M10	M11	M12	M13	M14	M15	M16	M17	M18	M19	M20	M21	M22	M23	M24	
CARELIA										SG approve AT1																
ANDALUSIA																SG approve AT2										
development AT [PP2, PP3]					11 pp identification and analysis								AT2part' info' with S1													
All PP answers at AT1 part											answers AT1 part															
All PP answers at AT2 part																x	answers AT1 part									
RAFVG																									SG analyze report AT	

During the implementation of the assessment tool, the LP will capitalize on the previous experiences acquired in the management of European projects, such as SMART CAMPUS and CEEM (project financed by the Central Europe Program through ERDF funds which aimed to provide SMEs with environmentally friendly technologies, operating methods, good practices and an IT tool to self-evaluate their performance), in order to achieve the following objectives of the S3UNICA project:

- collection of information provided by Universities stakeholders and consequent sharing with other stakeholders during the RSM to create suitable conditions for involving new private actors and for promoting the use of public-private partnership (PPP) and public private procurement instruments;
- Identification of at least 20 good practices;
- Drafting of the “Technology and Policy Road Map”, selecting promising technologies and smart energy management systems;
- Drafting of 5 action plans to enhance regional policy instruments.

The first part of the assessment tool is structured as a survey, subdivided into four sections:

1. **POLICY SECTION:** it concerns the collection of information to monitor the current state of the policies implemented by the PPs in order to achieve energy efficiency on University campuses buildings and infrastructures;
2. **FINANCIAL SECTION:** on the basis of the data provided by the partners, it allows to check the availability of financial instruments aimed at implementing energy efficiency interventions on University campuses;
3. **TECHNICAL SECTION:** (a) it collects general information concerning University campuses buildings and infrastructures; (b) it reports the matrix of information necessary to the application of the SRI methodology, identifying the questionnaire for the collection of information related to row 1. "**Monitoring and measurement**" and row (2.) "**Technical solutions**";
4. **ENERGY EFFICIENCY, FUTURE SCENARIOS AND VISION:** it is requested on one hand, a self-assessment of the energy performance detected in campuses analyzing the obstacles encountered and the extent of the energy efficiency of the measures adopted, on the other hand it is requested the indication of the objectives of the political actions undertaken at various levels.

## POLICY SECTION

*[To be completed by PP and University]*

In order to understand the situation of the regulations supporting energy efficiency on university campuses, the following information is required from the partners, therefore the following questions need an answer from the single partner.



Are there policy[1] measures at any level (local, national) encouraging the **development of nZEB university buildings**? What has been already done and what results were achieved? Please give some examples.

*[1] A policy is a principle or protocol to guide decisions and achieve rational outcomes, defined by political agreement at local/national/EU levels and adopted by law;*

*1000 character(s) maximum*

Are there policy measures at any level (local, national) for encouraging the adoption of **smart monitoring and control systems**? What has been already done and what results were achieved? Please give some examples.

*1000 character(s) maximum*

Are there policy measures at any level (local, national) for encouraging an **integrated energy management system for university/public buildings**? What has been already done and what results were achieved? Please give some examples.

*1000 character(s) maximum*

Are there **self-implemented[1] energy efficiency policies** in place, not part of mandatory policies? What has been already done and what results were achieved? Please give some examples.

*[1] Specify if the university campus has implemented additional policy regulations not mandatory requested by the regional-national-EU levels;*

*1000 character(s) maximum*

Does your university campus **adhere to mandatory energy policies at any level** (local, national, EU)? If yes, please specify.

*1000 character(s) maximum*

Are there **measurable objectives or targets achieved or to be achieved by your university campus?** Please specify if the campus has set up/achieved targets and objectives, both quantitative (e.g. numbers to be achieved) or qualitative (e.g. general final objectives expressed in a to-do-list levels).

*1000 character(s) maximum*

Which policies have been implemented at local/regional national level or at campus level to promote the energy efficiency sector (i.e. development of innovative solutions, collaboration with private companies, support for the creation of universities spin-offs/start-ups to commercialize these new technologies, promotion of the interregional collaboration and projects at European level)? Please give some examples.

*1000 character(s) maximum*

What are the bottlenecks you have experienced with regard to the energy efficiency policy implementation?

*1000 character(s) maximum*

Being S3 an "ex ante " conditionality to access cohesion funds, S3Unica project will contribute to influence regional policy, starting from University achievements. Has your university contributed to the definition of your Regional S3/ development trajectories ? Or has your University benefited from existing S3 (i.e. energy related projects funded through ERDF)?

*1000 character(s) maximum*

---

## FINANCIAL SECTION

*[To be completed by PP and University]*

To understand the availability of financial instruments for the implementation of energy efficiency interventions on university campuses, each single partner should provide the following information.

### **Are the following financial instruments available?**

Energy Performance Contract;

*1000 character(s) minimum*

Mortgages for energy efficiency/Bank loans;

*1000 character(s) minimum*

•

•

•

•

•

•

•

•

•

State Incentives dedicated to Universities;

*1000 character(s) maximum*

National programs dedicated to energy efficiency works for public buildings;

*1000 character(s) maximum*

Dedicated credit institutions/bodies (EE funds) for energy efficiency works/Investments;

*1000 character(s) maximum*

Other financial systems or initiatives: specify

*1000 character(s) maximum*

Which financial schemes have been implemented to promote policies in the energy sector (i.e. development of innovative solutions, collaboration with private companies, support for the creation of



universities spin-offs/start-ups to commercialize these new technologies, promotion of the interregional collaboration and projects at European level)? Please give some examples.

*1000 character(s) maximum*

---

## **TECHNICAL SECTION**

*[To be completed by University]*

The following answers are required from the stakeholders (campuses) to collect general information within university campuses and to understand the technological state of the buildings:

In this section Identification information, status and size of campuses are collected

	Question Description
University Name	
Country	
City	
ZIP code	
Street name Number	
<p>Description of the campus</p> <p><i>[Insert a short and clear description of the campus: buildings (single or group of buildings, modern or historical), activities carried out ( teaching rooms, labs, auditorium, offices, hospitals, sports facilities,...)</i></p> <p><i>(max. 1000 characters).]</i></p>	
<p>Campus ownership</p> <p><i>[Property is the state of full possession of the assets used by the University.</i></p> <p><i>Rent is the state of contractual duty of these assets with an external owner.]</i></p>	
<p>Location</p> <p><i>[Specify if the University is located in a fully independent building or if it is shared.</i></p> <p><i>Specify if the buildings are isolated or integrated into a district with other activities,</i></p> <p><i>or if they are included like the other civil residences in the city]</i></p>	
<p>Number of employees</p> <p><i>[Indicate the number of students, lecturers, researchers, technicians,</i></p> <p><i>other staff present daily in buildings (reference: year 2019)]</i></p>	
<p>Area [m<sup>2</sup>]</p> <p><i>[Indicative value. Specify the net floor area occupied by the buildings,</i></p> <p><i>taking into account all features allocated (offices, teaching rooms, etc).]</i></p>	

Volume [m<sup>3</sup>]

*[Indicative value. Specify the net volume of the campus,  
taking into account all features allocated (offices, teaching rooms, etc).]*

In this section detailed information about different energy sources, final energy usage, consumption behavior, building structure, planned and adopted measures will be collected

	ABILITY TO MAINTAIN ENERGY PERFORMANCE AND OPERATION	ABILITY TO REPORT ON ENERGY USE	ADAPT ITS OPERATION MODE IN RESPONSE TO THE NEEDS OF THE OCCUPANT	MAINTAINING HEALTHY INDOOR CLIMATE CONDITIONS	FLEXIBILITY OF A BUILDING'S OVERALL ENERGY DEMAND
MONITORING AND MEASUREMENT					
TECHNICAL SOLUTIONS					



	ABILITY TO MAINTAIN ENERGY PERFORMANCE AND OPERATION	ABILITY TO REPORT ON ENERGY USE	ADAPT ITS OPERATION MODE IN RESPONSE TO THE NEEDS OF THE OCCUPANT	MAINTAINING HEALTHY INDOOR CLIMATE CONDITIONS	FLEXIBILITY OF A BUILDING'S OVERALL ENERGY DEMAND
MONITORING AND MEASUREMENT	Quality of the measure (entire building, single thermal zone, single service for example: lighting, air conditioning, other services	Frequency of measurements (annual, monthly, weekly); Quality of energy consumption measurement (system of buildings single building, single service for example: lighting, air conditioning, driving force);	Quality of the measure (system of buildings, single service for example: lighting, air conditioning, driving force) of temperature, relative humidity, CO <sub>2</sub> rate; lighting;	Quality of the measure (entire building, single service for example: lighting, air conditioning, driving force) of temperature, relative humidity, CO <sub>2</sub> rate;	Availability of system to monitor energy demand and local energy availability (in direct or simulated production);
	<b>A</b>	<b>B</b>	<b>C</b>	<b>D</b>	<b>E</b>
TECHNICAL SOLUTIONS	Supply capacity of thermal and cooling energy for system of buildings, single building or single thermal zone;		Supply capacity of thermal and cooling energy and adjustment of air changes depending on the needs of the occupants in the single areas;	Supply capacity of thermal and cooling energy and adjustment of air changes depending on the needs in the single areas;	Presence of energy production from renewable sources (Photovoltaic, geothermal, solar thermal); Availability of electrical energy storage; Availability of thermal energy storage; Ability to supply the necessary energy through the purchase of energy or local production from renewable sources or, also, through the integration with other availability in the territory (e.g. waste heat)

Monitoring and measurement:

	A
<p>Is there a dedicated office or person for energy management? <i>[Specify.]</i></p>	
<p>Is there a Building Management System (BMS) implemented? <i>[A Building Management System (BMS) is a computer-based control system installed in buildings that controls and monitors the building's mechanical and electrical equipment such as ventilation, lighting, power systems, fire systems, and security systems]</i></p>	
<p>Data Collection <i>[Specify. which quantities are measured (e.g.energy consumption, temperature, relative humidity, CO2 rate); indicate if the measurement is aggregated (for whole campus, single building, building zone) or single service (example.: lighting, air conditioning; thermal energy, driving force); for each of them give the measurement frequency (e.g. annual, monthly) weekly.)]</i></p>	
<p>Energy flow measurements <i>[Specify if this specific action is performed on campus and if it is implemented in the BMS]</i></p>	
<p>Energy cost analysis <i>[Specify if this specific action is performed on campus and if it is implemented in the BMS]</i></p>	
<p>Emission measurement <i>[Specify if this specific action is performed on campus and if it is implemented in the BMS]</i></p>	
<p>Other measurements <i>[Specify ]</i></p>	
<p>Was an indoor air quality test ever conducted in the building? <i>[Specify ]</i></p>	
<p>Did customers or employers ever report thermal comfort dissatisfaction? <i>[Specify ]</i></p>	

Technical solutions

	A
<b>Main Source for Electrical Power</b> <i>[Specify which is the main source for electrical power used within the campus]</i>	
<b>Additional Relevant Source for Electrical Power</b> <i>[Specify if you are using an additional relevant source for electrical power in your university]</i>	
<b>Type of Supply Electrical Energy Contract</b> <i>[Answer "metered" if you receive a bill from the utility company. Alternatively specify other methods]</i>	
<b>Yearly Electrical Energy Consumption [kWh] (reference year 2019)</b> <i>[Fill in the value of the electric energy consumption of one year]</i>	
<b>Yearly Electrical Energy Cost</b> <i>[Fill in the value for the total energy cost of one year of activities]</i>	
<b>Main Source for Space Heating</b> <i>[Specify the main source for space heating in the buildings]</i>	
<b>Main Fuel Type</b> <i>[Specify the main fuel type used by your company]</i>	
<b>Yearly main fuel Consumption (referred year: 2019)</b> <i>[Fill in the value for your total energy consumption of one year of operation and specify the reference unit for the specific fuel]</i>	
<b>Yearly main fuel Cost</b> <i>[Fill in the value for the total energy cost of one year of activities.]</i>	
<b>Main heating Conversion Technology</b> <i>[Specify which is the main conversion technology for space heating]</i>	
<b>Main Heating Distribution Technology</b> <i>[Specify the main distribution technology for space heat]</i>	
<b>Main Source for Space Cooling</b> <i>[Specify which is the main source for buildings cooling]</i>	
<b>Main Cooling Conversion Technology</b> <i>[Specify which is the main conversion technology for space cooling]</i>	

<p><b>Main Cooling Distribution Technology</b>  <i>[Specify the main distribution technology for space cooling]</i></p>	
<p><b>Additional relevant Fuels Type</b>  <i>[Specify if the University utilizes an additional relevant fuel type beside the main fuel type stated before]</i></p>	
<p><b>Type of additional fuels Supply Contract</b>  <i>[Answer "metered" if you receive a bill from the utility company.  Alternatively specify other methods]</i></p>	
<p><b>Yearly additional fuel Consumption (reference year: 2019)</b>  <i>[Fill in the value for your total energy consumption of one year of operation and  specify the reference unit for the specific fuel]</i></p>	
<p><b>Is there an on-site or off-site renewable energy system installed?</b>  <i>[Specify if the Campus has installed an energy system based on renewable sources  (e.g. solar, biomass, wind, geothermal, hydro)]</i></p>	
<p><b>Which kinds of renewable energy systems are installed?</b>  <i>[Select the proper system(s)]</i></p>	
<p><b>Percentage of Electrical Energy Consumption from Renewable Sources</b>  <i>[Specify the range of electrical energy consumption from renewable resources  according to the overall electrical energy consumption in your campus]</i></p>	
<p><b>Percentage of Thermal Energy Consumption from Renewable Sources</b>  <i>[Specify the range of thermal energy consumption from renewable resources  according to the overall thermal energy consumption in your campus]</i></p>	
<p><b>Renewable Electric Energy Self-Consumption [%]</b>  <i>[Specify percentage of self-consumed renewable electrical energy  according to the total self-produced renewable electrical energy ]</i></p>	
<p><b>Renewable Energy Systems Added Value [€]</b>  <i>[Specify the approximative added value in euros per year obtained from renewable energy systems  installed by your campus, as a sum of both energy discounts and feed-in tariff]</i></p>	
<p><b>Can you quantify approximately the overall savings achieved [%]?</b>  <i>[Indicate the approximate percentage for improvements yet achieved by the university  after above selected measures have been taken]</i></p>	
<p><b>Is there any additional potential for improvement in terms of energy efficiency?</b>  <i>[Specify if you consider that the University has a relevant potential for improving  the energy efficiency at any level of building, indoor, lab]</i></p>	



<p>Is there any additional potential for improvement in terms of energy efficiency?  <i>[Estimate the approximate percentage of improvements that could be achieved by the university through additional energy efficiency measures]</i></p>	
<p>Is there any innovative technologies/solutions developed by the University for improvement of energy efficiency and environment?  <i>[To describe other innovative solutions that are being developed by the University or even implemented at the testing level. ]</i></p>	
<p>Are there any innovative solutions developed at your University that need a scale up from TRL 5 to TRL9?  <i>[[NOTE] The idea of the Smart Campus project was to foster the interregional collaboration to promote innovation in the Universities Campuses, supporting innovative technologies to advance them from TRL 6 to TRL 8 or 9 through the collaboration between different universities.  One of the conclusions of the Smart Campus project was the need to enlarge the portfolio of innovative solutions.]</i></p>	
<p>If yes, what are the main bottlenecks you face for the scaling up?  <i>[]</i></p>	

## **ENERGY EFFICIENCY, FUTURE SCENARIOS AND VISION SECTION**

*[To be completed by University]*

In this section both a self-assessment of campus performance (in accordance with the barriers, obstacles and relevance of energy efficiency) and targets at various levels of policy actions is required.

Relevance of energy efficiency, future outlook and Vision:

	A
<p>Impact of energy efficiency measures during last three years?  <i>[Specify if the university is considering to receive back a positive impact from energy efficient measures adopted in last three years (1 means not receiving any positive impact, 5 means very high positive impact).]</i></p>	
<p>Did you find obstacles on energy efficiency measures and their implementation?  <i>[Specify, whenever the university has had some obstacles, in implementing EE measures]</i></p>	
<p>Have you been able to overcome obstacles on energy efficiency measures and their implementation?  <i>[Specify, whenever the university has had some obstacles, if it has been able to overcome them and correctly implement target actions]</i></p>	
<p>No idea of energy efficient measures  <i>[Rate the relevance of this obstacle or barrier for the university energy efficiency either on the basis of your direct experience or according to your knowledge of the field (give a score between 1 and 5, 1 means small obstacle or low relevance, 5 means big obstacle or high relevance)]</i></p>	
<p>Time and staff resources in the company  <i>[See above]</i></p>	
<p>External support (technical or economic)  <i>[See above]</i></p>	
<p>Financial issues: Absence of dedicated budget for improvement of energy efficiency  <i>[See above]</i></p>	
<p>Long pay-back period for possible projects  <i>[See above]</i></p>	
<p>Others obstacles  <i>[Specify]</i></p>	

<p>Which are the obstacles for the development/application of innovative technologies/solutions developed by the University (if any) for improvement of energy efficiency?  <i>[on the basis of your direct experience specify the bottlenecks of innovative solutions that are being developed by the University or even implemented at the testing level]</i></p>	
<p>Have you planned to implement (additional) energy efficiency policies in your university?  <i>[Specify an already planned intention to implement energy efficiency measures in the University, ]</i></p>	
<p>In which time framework  <i>[Indicate the time horizon of eventually planned actions to be implemented by the university in the next future]</i></p>	
<p>Which reduction in overall energy consumption is expected?  <i>[Indicate the percentage of expected reduction in energy consumption expected from the planned actions to be implemented by the university in the next future]</i></p>	
<p>Which reduction of fossil fuels is expected?  <i>[Indicate the percentage of expected reduction in energy from fossil fuels expected from the planned actions to be implemented by the university in the next future]</i></p>	
<p>What is the “energy culture” spread at your university campus?  (i.e. do students know about campus energy savings goals, is there any piece of information on this,...)  <i>[Specify]</i></p>	



Data of the contact person responsible for the questionnaire:

	data
Name	
Surname	
Institution email	
Telephone	

## Contact

s3unica@regione.fvg.it

# Annex 2

# Smart Readiness Indicator

Domain	Theme	Code	Service group	Smart ready service	Functionality level 0 (as non-smart default)	Functionality level 1	Functionality level 2	Functionality level 3	Functionality level 4	part of the proposed simplified indicator	Preconditions / Dependency on other services or building types
Heating	Controllability of Performance: Emission	Heating-S1	Heat control - demand side	Heat emission control	No automatic control	Central automatic control (e.g. central thermostat)	Individual room control (e.g. thermostatic valves, or electronic controller)	Individual room control with communication between controllers and to BACS	Individual room control with communication and presence control	1	Always to be assessed (if domain is relevant)
Heating	Controllability of Performance: Production	Heating-S2a	Control heat production facilities	Heat generator control (all except heat pumps)	Constant temperature control	Variable temperature control depending on outdoor temperature	Variable temperature control depending on the load (e.g. depending on supply water temperature set point)			1	Not applicable to heat pumps
Heating	Controllability of Performance: Production	Heating-S2b	Control heat production facilities	Heat generator control (heat pumps)	On/Off-control of heat generator	Multi-stage control of heat generator capacity depending on the load or demand (e.g. on/off of several compressors)	Variable control of heat generator capacity depending on the load or demand (e.g. hot gas bypass, inverter frequency control)	Variable control of heat generator capacity depending on the load AND external signals from grid		1	Only applicable in case of a heat pump
Heating	Storage & Connectivity	Heating-S3	Control heat production facilities	Storage and shifting of thermal energy	None	HW storage vessels available	HW storage vessels controlled based on external signals (from BACS or grid)			1	Only applicable if storage is present
Heating	Reporting functionalities	Heating-S4	Information to occupants and facility management	Report information regarding heating system performance	None	Central or remote reporting of current performance KPIs (e.g. temperatures, submetering energy usage)	Central or remote reporting of current performance KPIs and historical data	Central or remote reporting of performance evaluation including forecasting and/or benchmarking	Central or remote reporting of performance evaluation including forecasting and/or benchmarking; also including predictive management and fault detection	1	Always to be assessed (if domain is relevant)
Domestic hot water	Controllability of Performance	DHW-S1	Control DHW production facilities	Control of DHW storage charging (with direct electric heating or integrated electric heat pump)	Automatic control on / off	Automatic control on / off and scheduled charging enable	Automatic on/off control, scheduled charging enable and demand-based supply temperature control or multi-sensor storage management			1	Only applicable in case of DHW storage with electric heating
Domestic hot water	Storage & Connectivity	DHW-S2	Flexibility DHW production facilities	Control of DHW storage charging	None	HW storage vessels available	Automatic charging control based on local availability of renewables or information from electricity grid (DR, DSM)			1	Only applicable if storage is present
Domestic hot water	Information to occupants	DHW-S3	Information to occupants and facility managers	Report information regarding domestic hot water performance	None	Indication of actual values (e.g. temperatures, submetering energy usage)	Actual values and historical data	Performance evaluation including forecasting and/or benchmarking	Performance evaluation including forecasting and/or benchmarking; also including predictive management and fault detection	1	Always to be assessed (if domain is relevant)

Functionality level	
3	Level 3
0	Level 0
2	Level 2
0	Level 0
2	Level 2
0	Level 0
2	Level 2
1	Level 1



Cooling	Controllability of Performance: Emission	Cooling-S1	Cooling control - demand side	Cooling emission control	No automatic control	Central automatic control (e.g. central thermostat)	Individual room control (e.g. thermostatic valves, or electronic controller)	Individual room control with communication between controllers and to BACS	Individual room control with communication and occupancy detection	1	Always to be assessed (if domain is relevant)
Cooling	Controllability of Performance: Production	Cooling-S2	Control cooling production facilities	Generator control for cooling	On/Off-control of cooling production	Multi-stage control of cooling production capacity depending on the load or demand (e.g. on/off of several compressors)	Variable control of cooling production capacity depending on the load or demand (e.g. hot gas bypass, inverter frequency control)	Variable control of cooling production capacity depending on the load AND external signals from grid		1	Always to be assessed (if domain is relevant)
Cooling	Storage & Connectivity	Cooling-S3	Flexibility and grid interaction	Flexibility and grid interaction	No automatic control	Scheduled operation of cooling system	Self-learning optimal control of cooling system	Cooling system capable of flexible control through grid signals (e.g. DSM)	Optimized control of cooling system based on local predictions and grid signals (e.g. through model predictive control)	1	Only applicable if storage is present
Cooling	Reporting functionalities	Cooling-S4	Information to occupants and facility managers	Report information regarding cooling system performance	None	Central or remote reporting of current performance KPIs (e.g. temperatures, submetering energy usage)	Central or remote reporting of current performance KPIs and historical data	Central or remote reporting of performance evaluation including forecasting and/or benchmarking	Central or remote reporting of performance evaluation including forecasting and/or benchmarking; also including predictive management and fault detection	1	Always to be assessed (if domain is relevant)
Controlled ventilation	Controllability of Performance	Ventilation-S1	Air flow control	Supply air flow control at the room level	No ventilation system or manual control	Clock control	Occupancy detection control	Central Demand Control based on air quality sensors (CO2, VOC,...)	Local Demand Control based on air quality sensors (CO2, VOC,...) with local flow from/to the zone regulated by dampers	1	Always to be assessed (if domain is relevant)
Controlled ventilation	Reporting functionalities	Ventilation-S3	Feedback - Reporting information	Reporting information regarding IAQ	None	Air quality sensors (e.g. CO2) and real time autonomous monitoring	Real time monitoring & historical information of IAQ available to occupants	Real time monitoring & historical information of IAQ available to occupants + warning on maintenance needs or occupant actions (e.g. window opening)		1	Always to be assessed (if domain is relevant)
Lighting	Controllability of Performance	Lighting-S1	Artificial lighting control	Occupancy control for indoor lighting	Manual on/off switch	Manual on/off switch + additional sweeping extinction signal	Automatic detection (auto on / dimmed or auto off)	Automatic detection (manual on / dimmed or auto off)		1	Always to be assessed (if domain is relevant)
Dynamic building envelope	Controllability of Performance	DE-S1	Window control	Window solar shading control	No sun shading or only manual operation	Motorized operation with manual control	Motorized operation with automatic control based on sensor data	Combined light/blind/HVAC control	Predictive blind control (e.g. based on weather forecast)	1	Only applicable in case movable shades, screens or blinds are present

3	Level 3
2	Level 2
0	Level 0
2	Level 2
1	Level 1
0	Level 0
2	Level 2
0	Level 0

Dynamic building envelope	Reporting functionalities	DE-S3	Feedback - Reporting information	Reporting information regarding performance	No reporting	Position of each product & fault detection	Position of each product, fault detection & predictive maintenance	Position of each product, fault detection, predictive maintenance, real-time sensor data (wind, lux, temperature...)	Position of each product, fault detection, predictive maintenance, real-time & historical sensor data (wind, lux, temperature...)	1	Only applicable in case movable shades, screens or blinds are present
Electricity	Storage & Connectivity	Electricity-S1	Storage	Storage of (locally generated) electricity	None	On site storage of electricity (e.g. electric battery)	On site storage of energy (e.g. electric battery or thermal storage) with controller based on grid signals	On site storage of energy (e.g. electric battery or thermal storage) with controller optimising the use of locally generated electricity	On site storage of energy (e.g. electric battery or thermal storage) with controller optimising the use of locally generated electricity and possibility to feed back into the grid	1	Only applicable in case of local energy generation
Electricity	Reporting functionalities	Electricity-S2	Electricity Loads	Reporting information regarding electricity consumption	None	reporting on current electricity consumption on building level	real-time feedback or benchmarking on building level	real-time feedback or benchmarking on appliance level	real-time feedback or benchmarking on appliance level with automated personalized recommendations	1	
Electricity	Reporting functionalities	Electricity-S3	Renewables	Reporting information regarding local electricity generation	None	Current generation data available	Actual values and historical data	Performance evaluation including forecasting and/or benchmarking	Performance evaluation including forecasting and/or benchmarking; also including predictive management and fault detection	1	Only applicable in case of local energy generation
Electricity	Reporting functionalities	Electricity-S4	Storage	Reporting information regarding energy storage	None	Current state of charge (SOC) data available	Actual values and historical data	Performance evaluation including forecasting and/or benchmarking	Performance evaluation including forecasting and/or benchmarking; also including predictive management and fault detection	1	Only applicable in case of local energy generation
Electric vehicle charging		EV-S1	EV Charging	Charging capacity	not present	ducting (or simple power plug) available	0-9% of parking spaces has recharging points	10-50% or parking spaces has recharging point	>50% of parking spaces has recharging point	1	Always to be assessed (if domain is relevant)
Electric vehicle charging	Storage & Connectivity	EV-S3	EV Charging - Grid	EV Charging Grid balancing	Not present (uncontrolled charging)	1-way controlled charging (e.g. including desired departure time and grid signals for optimization)	2-way controlled charging (e.g. including desired departure time and grid signals for optimization)			1	Only to be assessed if EV charging available on site
Electric vehicle charging	Reporting functionalities	EV-S4	EV Charging - connectivity	EV charging information and connectivity	No information available	Reporting information on EV charging status to occupant	Reporting information on EV charging status to occupant AND automatic identification and authorization of the driver to the charging station (ISO 15118 compliant)			1	Only to be assessed if EV charging available on site
Monitoring and control	Controllability of Performance	MC-S1	TBS interaction control	Single platform that allows automated control & coordination between TBS + optimization of energy flow based on occupancy, weather and grid signals	None	Single platform that allows manual control of multiple TBS	Single platform that allows automated control & coordination between TBS	Single platform that allows automated control & coordination between TBS + optimization of energy flow based on occupancy, weather and grid signals		1	Always to be assessed
Monitoring and control	Flexibility	MC-S2	Smart Grid Integration	Smart Grid Integration	None - No harmonization between grid and TBS; building is operated independently from the grid load	Demand side management possible for (some) individual TBS, but not coordinated over various domains	Coordinated demand side management of multiple TBS			1	Always to be assessed

0	Level 0
0	Level 0
1	Level 1
2	Level 2
0	Level 0
2	Level 2
1	Level 1
1	Level 1
1	Level 1
1	Level 1

Monitoring and control	Information to occupants	MC-53	Feedback - Reporting information	Central reporting of TBS performance and energy use	None	Central or remote reporting of realtime energy use per energy carrier	Central or remote reporting of realtime energy use per energy carrier, combining TBS of at least 2 domains in one interface	Central or remote reporting of realtime energy use per energy carrier, combining TBS of all domains in one interface		1	Always to be assessed
------------------------	--------------------------	-------	----------------------------------	---	------	---	---	--	--	---	-----------------------

<b>1</b>	Level 1
----------	---------

SRI %	Energy Saving and operation		Respond to user needs			Respond to needs of the grid	
	Energy savings on site	Maintenance & fault prediction	Comfort	Convenience	Health & wellbeing	information to occupants	Flexibility for the grid and storage
Heating	63%	100%	20%	67%	75%	50%	63%
Domestic hot water	33%	Not applicable	75%	Not applicable	40%	50%	33%
Cooling	63%	67%	17%	57%	43%	50%	63%
Controlled ventilation	33%	17%	Not applicable	33%	33%	0%	33%
Lighting	67%	Not applicable	Not applicable	100%	100%	Not applicable	67%
Dynamic building envelope	0%	0%	Not applicable	0%	0%	0%	0%
Electricity	20%	Not applicable	0%	Not applicable	0%	17%	20%
Electric vehicle charging	Not applicable	Not applicable	25%	Not applicable	83%	Not applicable	Not applicable
Monitoring and control	25%	Not applicable	67%	Not applicable	29%	50%	25%

<b>SRI</b>
<b>39,69%</b>